



JDV
CONTROL
VALVES



JBF-F Type

Floating Type Soft Seat Ball Valve



*We link all you need
and more than you expect.*



**JDV
CONTROL
VALVES**

JBF-F

Floating Type Soft Seat Ball Valve

Full Bore Two-Piece Flanged Ends

JIS 10/20K ASME CLASS 150/300/600 DIN PN16/40/100



Industrial Fields:

Oil & Gas
Refinery / Petrochemical
Chemical
Pulp & Paper
Power Plant
Steel Mill
Food
Mining

JBF-F Type is quarter-turn ball valves engineered to provide a reliable performance for a wide range of applications. Our vanguard design with many technically advanced features (optional fire-safe, longer stem, live loading, etc.) guarantees the highest level of safety and integrity.

Applicable Standards

- Body Material : Standard in WCB, CF8, CF8M. Other materials are available according to requirements.
- Nominal Size : 1/2" to 8" (DN15 to DN200)
- Pressure Rating : JIS 10/20K ASME CLASS 150/300/600 DIN PN16/40/100
- End Connections : RF
- Temperature Range : -58~446°F (-50~230 °C)
- Face-To-Face Dimensions : JIS B2002 | ASME B16.10 / EN558 Series R27
- Flanged Dimensions : JIS B2220 / ASME B16.5 / EN1092-1
- Body Pressure Test : JIS B2003 / ASME B16.34 / API 598 / EN12266-1
- Seat Leakage Test : JIS B2003 / ASME B16.34 / API 598 / EN12266-1
- Casting : MSS-SP-25 / MSS-SP-55
- Fire Safe Design : Certificated according to API 607



Options:

1. Fire-Safe Design Conforms To API 607
2. Long Stem



API 607

Design & Structure

Fire Safe Design

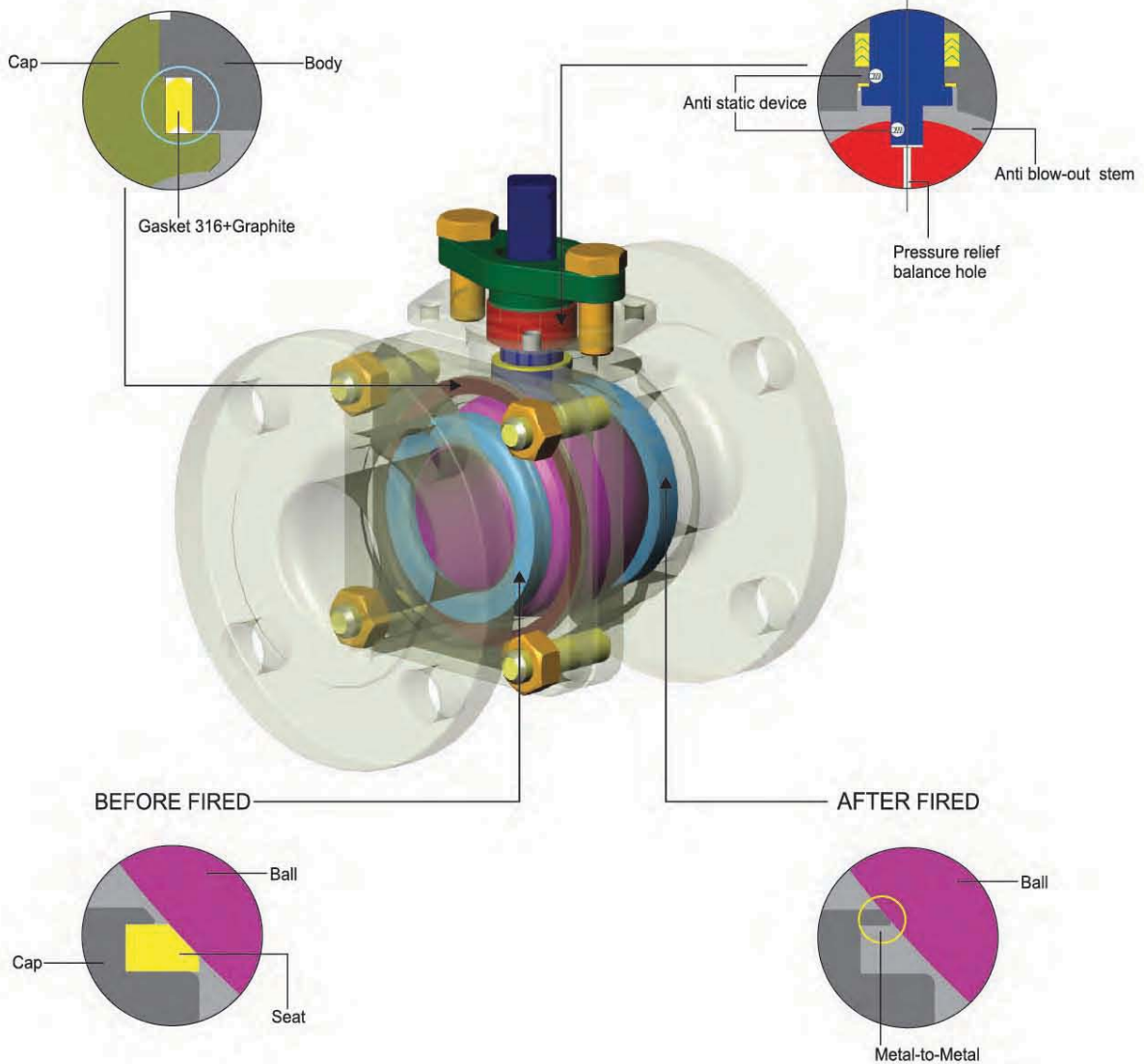

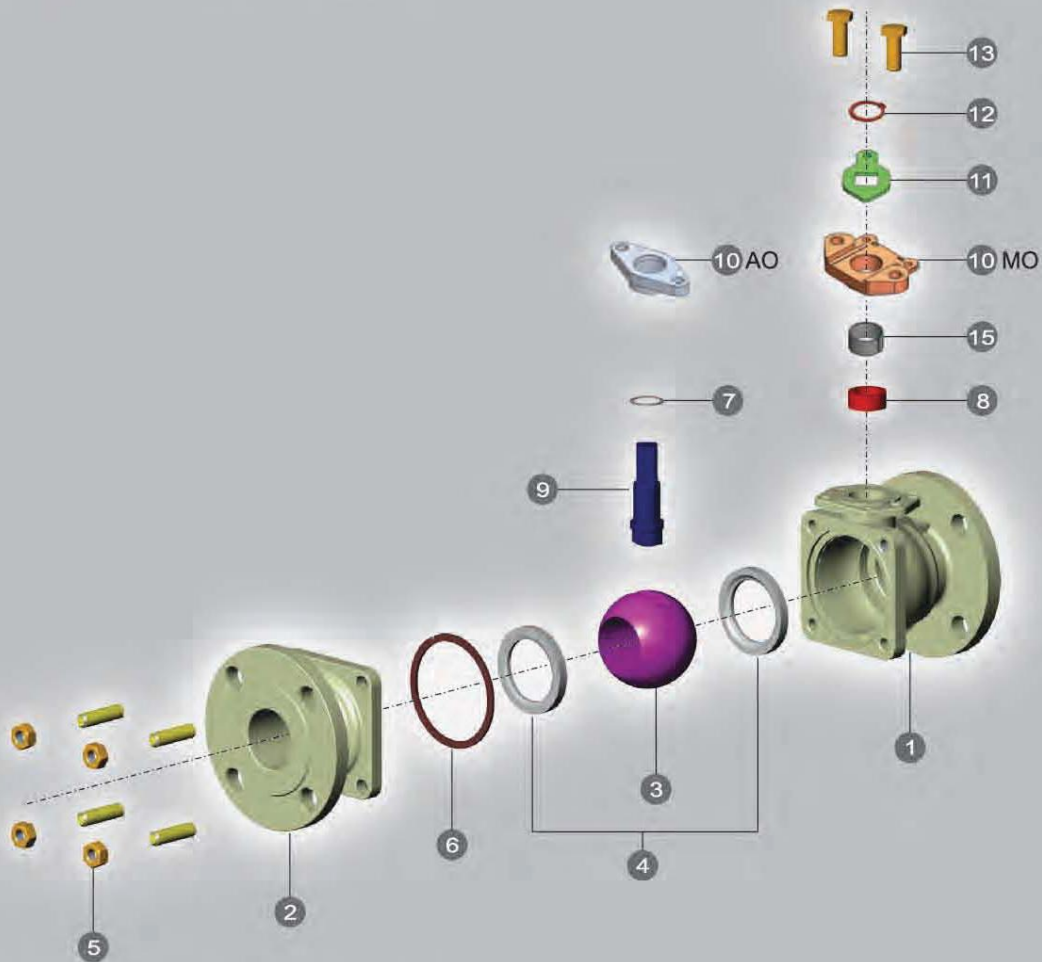

Technical Specifications

STANDARD MATERIALS

NO	PART NAME	MATERIAL		
1	BODY	A216-WCB	A351-CF8	A351-CF8M
2	CAP	A216-WCB	A351-CF8	A351-CF8M
3	BALL	A351-CF8		A351-CF8M
4	SEAT	PTFE / G-PTFE / C-PTFE / TFM-1600		
5	BOLT&NUT	A193-B7 & A194-7	A193-B8 & A194-8	
6	BODY GASKET	PTFE / 316SS+GRAPHITE (FIRE SAFE)		
7	THRUST WASHER	PTFE		
8	GLAND PACKING	PTFE / GRAPHITE(FIRE SAFE)		
9	STEM	A276-304	A276-316	
10	GLAND ⁽¹⁾	A351-CF8		
11	TRAVEL STOP (MO)	A240-304		
12	SNAP CATCH (MO)	AISI-420		
13	GLAND BOLT	STAINLESS STEEL		
14	HANDLE (MO)	A240-304(1/2"~1") / FCD45(1-1/2"~3") / FCD45+SGP(4" AND ABOVE)		
15	GLAND BEARING	G-PTFE		

The above materials may be changed with different using conditions.

Cv VALUES

Size	DN15	DN20	DN25	DN40	DN50	DN65	DN80	DN100	DN125	DN150	DN200
	1/2"	3/4"	1"	1-1/2"	2"	2-1/2"	3"	4"	5"	6"	8"
Cv	27	61	114	268	501	750	1158	2118	3812	5074	9337

PRESSURE DROP vs FLOW RATE

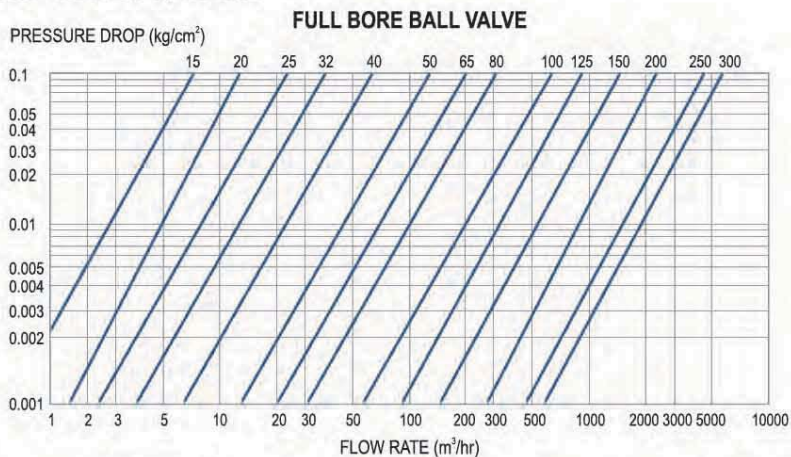

TEMPERATURE & PRESSURE DIAGRAM

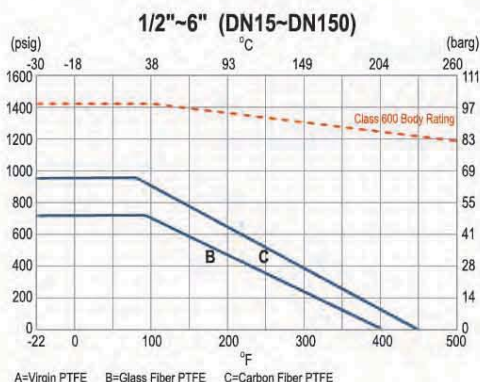
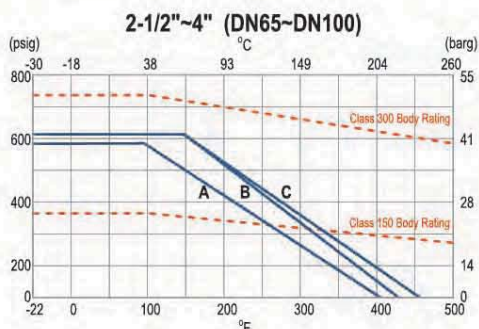
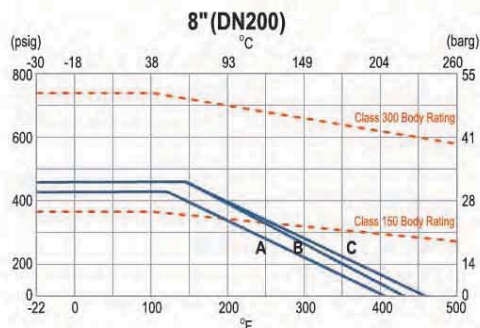
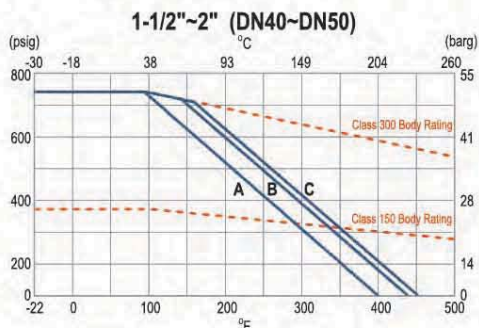
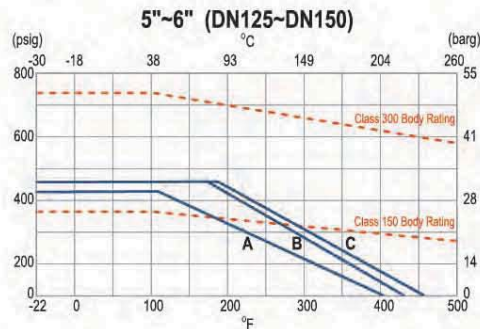
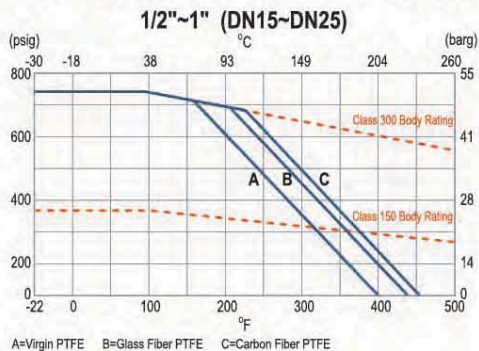



JDV CONTROL VALVES

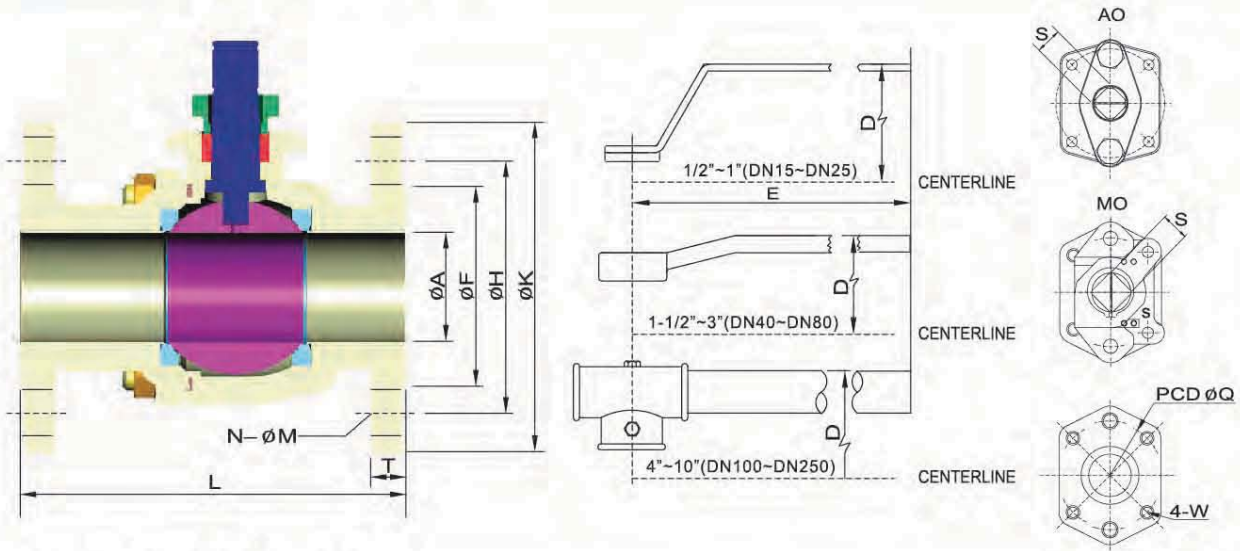

DIMENSIONS (JIS-10K)

(mm)

Size	A	F	H	K	M	N	L	T	S	Q	W	D	E	Wt (Kg)	
15	1/2"	15	51	70	95	15	4	108	12	10	42	M5	97	130	1.9
20	3/4"	20	56	75	100	15	4	117	14	10	42	M5	100	130	2.3
25	1"	25	67	90	125	19	4	127	14	12	50	M6	110	160	3.8
40	1-1/2"	38	81	105	140	19	4	165	16	17	70	M8	115	224	6.7
50	2"	50	96	120	155	19	4	178	16	17	70	M8	120	224	8.5
65	2-1/2"	65	116	140	175	19	4	190	18	20	70	M8	140	324	14
80	3"	76	126	150	185	19	8	203	18	20	70	M8	150	324	18
100	4"	100	151	175	210	19	8	229	18	27	102	M10	220	400	26
125	5"	125	182	210	250	23	8	356	20	27	102	M10	240	550	42
150	6"	150	212	240	280	23	8	394	22	32	125	M12	280	550	65
200	8"	201	262	290	330	23	12	457	22	35	140	M16	340	1000	120

DIMENSIONS (JIS-20K)

(mm)

Size	A	F	H	K	M	N	L	T	S	Q	W	D	E	Wt (Kg)	
15	1/2"	15	51	70	95	15	4	140	14	10	42	M5	97	130	2.4
20	3/4"	20	56	75	100	15	4	152	16	10	42	M5	100	130	3
25	1"	25	67	90	125	19	4	165	16	12	50	M6	110	160	5
40	1-1/2"	38	81	105	140	19	4	190	18	17	70	M8	115	224	9.5
50	2"	50	96	120	155	19	8	216	18	17	70	M8	120	224	12
65	2-1/2"	65	116	140	175	19	8	241	20	20	70	M8	140	324	21.5
80	3"	76	132	160	200	23	8	282	22	20	70	M8	150	324	30
100	4"	100	160	185	225	23	8	305	24	27	102	M10	220	400	45
150	6"	150	230	260	305	25	12	403	28	32	125	M12	280	550	95
200	8"	201	275	305	350	25	12	502	30	35	140	M16	340	1000	162

DIMENSIONS (ASME CLASS-150)

(mm)

Size	A	F	H	K	M	N	L	T	S	Q	W	D	E	Wt (Kg)	
15	1/2"	15	35	60.5	89	16	4	108	11.2	10	42	M5	97	130	1.7
20	3/4"	20	43	70	98	16	4	117	11.2	10	42	M5	100	130	2
25	1"	25	51	79.5	108	16	4	127	11.2	12	50	M6	110	160	2.8
40	1-1/2"	38	73	98.5	127	16	4	165	14.3	17	70	M8	115	224	5.8
50	2"	50	92	120.5	152	19	4	178	15.9	17	70	M8	120	224	8.5
65	2-1/2"	65	105	139.5	178	19	4	190	17.5	20	70	M8	140	324	12.5
80	3"	76	127	152.5	190	19	4	203	19.1	20	70	M8	150	324	16.2
100	4"	100	157	190.5	229	19	8	229	23.9	27	102	M10	220	400	26.6
125	5"	125	186	216	254	22	8	356	23.9	27	102	M10	240	550	42
150	6"	150	216	241.5	279	22	8	394	25.4	32	125	M12	280	550	59.2
200	8"	201	270	298.5	343	22	8	457	28.6	35	140	M16	340	1000	120

DIMENSIONS (ASME CLASS-300)

(mm)

Size	A	F	H	K	M	N	L	T	S	Q	W	D	E	Wt (Kg)	
15	1/2"	15	35	66.5	95	16	4	140	14.3	10	42	M5	97	130	2.4
20	3/4"	20	43	82.5	117	19	4	152	15.9	10	42	M5	100	130	3
25	1"	25	51	89	124	19	4	165	17.5	12	50	M6	110	160	4.29
40	1-1/2"	38	73	114.5	156	22	4	190	20.7	17	70	M8	115	224	9.5
50	2"	50	92	127	165	19	8	216	22.3	17	70	M8	120	224	12
65	2-1/2"	65	105	149	190	22	8	241	25.4	20	70	M8	140	324	21.5
80	3"	76	127	168	210	22	8	282	28.6	20	70	M8	150	324	30
100	4"	100	157	200	254	22	8	305	31.8	27	102	M10	220	400	45
125	5"	125	186	235	280	22	12	381	35.2	32	125	M12	260	550	65.1
150	6"	150	216	270	318	22	12	403	36.6	32	125	M12	280	550	95
200	8"	201	270	330	381	25	12	502	41.2	35	140	M16	340	1000	162

DIMENSIONS (ASME CLASS-600)

(mm)

Size	A	F	H	K	M	N	L	T	S	Q	W	D	E	Wt (Kg)	
15	1/2"	15	35	66.5	95	16	4	165	20.9	10	42	M5	97	130	2.8
20	3/4"	20	43	82.5	117	19	4	190	22.3	10	42	M5	100	130	3.9
25	1"	25	51	89	124	19	4	216	23.9	12	50	M6	110	160	4.6
40	1-1/2"	38	73	114.5	156	22	4	241	28.7	17	70	M8	115	224	10
50	2"	50	92	127	165	19	8	292	31.8	17	70	M8	130	224	16
65	2-1/2"	65	105	149	190	22	8	330	35	22	102	M10	190	324	29
80	3"	76	127	168	210	22	8	356	38.2	22	102	M12	200	324	35
100	4"	100	157	216	273	25	8	432	44.5	27	125	M12	240	550	66
150	6"	150	216	292	356	29	12	559	54.1	35	140	M16	310	1000	148

DIMENSIONS (DIN PN16)

(mm)

Size	A	F	H	K	M	N	L		T	S	Q	W	D	E	Wt (Kg)		
							S1	S27							S1	S27	
DN 15-DN 50 USE PN40																	
65	2-1/2"	65	122	145	185	18	8	290	170	18	20	70	M8	140	324	16.7	15
80	3"	76	138	160	200	18	8	310	180	20	20	70	M8	150	324	21	19
100	4"	100	158	180	220	18	8	350	190	20	27	102	M10	220	400	34.9	31
150	6"	150	212	240	285	22	8	480	350	22	32	125	M12	280	550	67.4	62
200	8"	201	268	295	340	22	12	600	400	24	35	140	M16	340	1000	164.5	152

DIMENSIONS (DIN PN40)

(mm)

Size	A	F	H	K	M	N	L		T	S	Q	W	D	E	Wt (Kg)		
							S1	S27							S1	S27	
15	1/2"	15	45	65	95	14	4	130	115	16	10	42	M5	97	130	2.6	2.5
20	3/4"	20	58	75	105	14	4	150	120	18	10	42	M5	100	130	2.9	2.8
25	1"	25	68	85	115	14	4	160	125	18	12	50	M6	110	160	4.1	3.8
40	1-1/2"	38	88	110	150	18	4	200	140	18	17	70	M8	115	224	8.6	8
50	2"	50	102	125	165	18	4	230	150	20	17	70	M8	120	224	12.5	11.7
65	2-1/2"	65	122	145	185	18	8	290	170	22	20	70	M8	140	324	24	22
80	3"	76	138	160	200	18	8	310	180	24	20	70	M8	150	324	34.5	28
100	4"	100	162	190	235	22	8	350	190	24	27	102	M10	220	400	37.3	33
150	6"	150	218	250	300	26	8	480	350	28	32	125	M12	280	550	86.5	80
200	8"	201	285	320	375	30	12	600	400	34	35	140	M16	340	1000	161.3	145

DIMENSIONS (DIN PN100)

(mm)

Size	A	F	H	K	M	N	L	T	S	Q	W	D	E	Wt (Kg)	
							S5							S1	S27
15	1/2"	15	45	75	105	14	4	165	20	10	42	M5	97	130	2.8
25	1"	25	68	100	140	18	4	216	24	12	50	M6	110	160	4.6
40	1-1/2"	38	88	125	170	22	4	241	28	17	70	M8	115	224	10
50	2"	50	102	145	195	26	4	292	30	17	70	M8	130	224	16
65	2-1/2"	65	122	170	220	26	8	330	34	22	102	M10	190	324	29
80	3"	76	138	180	230	26	8	356	36	22	102	M10	200	324	35
100	4"	100	162	210	265	30	8	432	40	27	125	M12	240	550	66

HOW TO ORDER

JBF-F → A → B → C → D → E → F → G

Ex: JBF-F → C2 → 04 → C → G → 03 → 050 → FH

A. SPECIFICATION	B. BODY MAT'L	C. BALL MAT'L	D. SEAT MAT'L	E. STEM MAT'L	F. SIZE
A1 JIS 10K	02 WCB (1.0619)	A CF8	P PTFE	02 304	015 1/2"
A2 JIS 20K	03 CF8 (1.4308)	C CF8M	G G-PTFE (15% GLASS FIBER+PTFE)	03 316	020 3/4"
C1 ASME CLASS 150	04 CF8M (1.4408)	D CF3	C C-PTFE (15% CARBON+PTFE)	05 317	025 1"
C2 ASME CLASS 300	05 CF3 (1.4306)	E CF3M	S S-PTFE (50% 316+PTFE)	07 304L	040 1-1/2"
C3 ASME CLASS 600	06 CF3M (1.4404)	F CG8M	T TFM-1600	08 316L	050 2"
D2 DIN PN16	07 CG8M (1.4412)	I CD3MN	E PEEK	10 S31803	065 2-1/2"
D4 DIN PN40	11 LCB (1.1138)				080 3"
D5 DIN PN100	12 LCC (1.7219)				100 4"
	13 CD3MN (1.4470)				125 5"
					150 6"
					200 8"
				G. OPTION	
				F FIRE SAFE	
				L EXTENDED STEM	
				I LIVE LOADING	
				H LEVER	
				A BARE SHAFT	

※ Alternative materials are available on request.



■ HEADQUARTERS

NO. 6-1, QINGNIAN RD., YANGMEI DIST., TAOYUAN CITY 326, TAIWAN
TEL +886-3-4965066 FAX +886-3-4963526 E-MAIL: sales@jdv.com.tw



Copyright 2021/07. All rights are reserved by JDV.
The technical data and content may be changed without prior notice.