

Unilok[®] Tube Fittings



SSP
Instrumentation
A DIVISION OF SSP FITTINGS CORP.

www.sspfittings.com

**QUALITY
INSTRUMENTATION
FITTINGS**



Made in USA



SSP Fittings Corp. / SSP Instrumentation

Table of Contents

How to Order	3
Tube Fittings Selection Guide	4-6
Unilok Tube Fittings General Information	7-8
Interchangeability	8
Installation Instructions	9
Presetting Tool	10
Gageability	10
Tube Fittings	11-47
Components	48-49
Selection Guide for Instrument Fittings & Tubing	50-53
Safety Information	54
Warranty	54

SSP Instrumentation

It takes a team of experts working together to become a recognized leader in the instrumentation tube fitting marketplace. SSP Instrumentation combines the finest in manufacturing equipment and expertise with state-of-the-art design engineering, outstanding quality assurance, superior customer service, and an efficient inventory distribution system to accomplish the task.

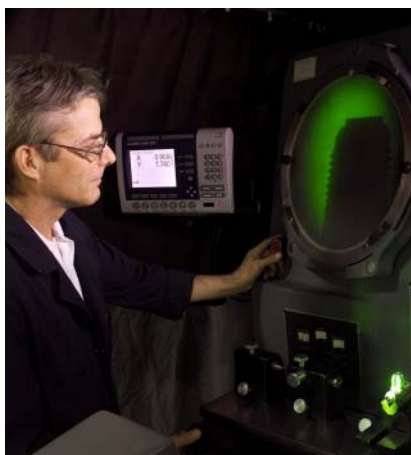
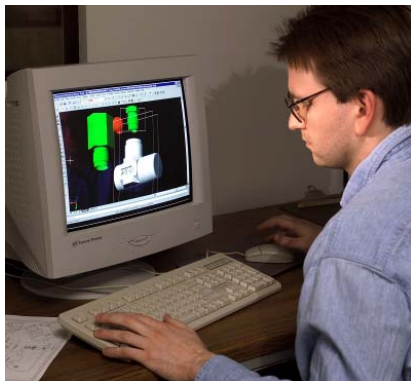

SSP Fittings Corp.

Since its inception in 1926, SSP has developed into an internationally recognized manufacturer of the highest quality, machined products. This successful U.S. corporation's heritage of craftsmanship and business expertise provide the foundation for an instrumentation division specializing in providing alternatives in instrumentation quality tube fittings.



Unilok® is a registered trademark of SSP Fittings Corp.
Monel® is a registered trademark of Inco Alloys International
Teflon® & Viton® are registered trademarks of E.I. duPont de Nemours
Hastelloy® is a registered trademark of Haynes International Inc.
Swagelok® is a registered trademark of the Swagelok Co.
Tygon® is a registered trademark of Norton Performance Plastics Corp.

NOTICE: This publication is an uncontrolled copy of a controlled document. SSP Instrumentation has made every reasonable effort to insure the accuracy of the information contained in this publication, and is not to be held liable in any manner for any mistakes, omissions, typographical and/or printing errors.

How to Order Unilok Tube Fittings

Example: ISSU4MC2

ISS	U	4	MC	2
------------	----------	----------	-----------	----------

 Instrumentation Material Designator (See Chart #1)	 SSP Brand Designator U = Unilok	 Tube O.D. (See Chart #2)	 Type of Tube Fitting (See Chart #3)	 2nd end connection is required for a reduced size tube O.D. or a differing type of end connection such as MNPT, FNPT, etc. (See Chart #2)
---	---	---------------------------------	---	---

For special application tees, a 3rd end connection is required for a reduced size tube O.D. or a differing type of end connection such as MNPT, FNPT, etc. (See Chart #2)

NOTES:

All Configurations: Only one size indicator is necessary when all of the connections are the same type and size.

Straights and Elbows: Specify the largest tube end first followed by the smaller tube end or differing type of connection (MNPT, FNPT, etc.).

Tees and Crosses: Tees are described by first sizing the run (1 to 2) and then the branch (3). Crosses are described by first sizing the run (1 to 2) and then the branch (3 to 4). See Figure 1.

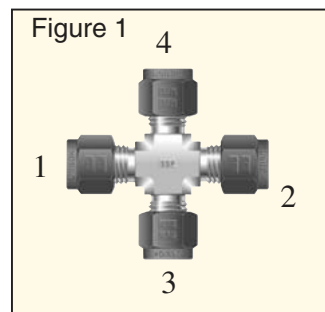

Specials: SSP Instrumentation manufactures a wide variety of special application tube fittings. Contact your local distributor for details regarding availability of special tube fitting configurations, materials and sizes.

CHART #1	
Instrumentation Material Designator	Material
IB	Brass
ISS	316 Stainless Steel
ICS	Carbon Steel
IHC	Hastelloy® C
IM	Monel®
IN*	Nylon
IPFA*	PFA Teflon®
ITFE*	PTFE Teflon®

* Ferrules Only



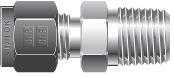







CHART #2 Part # Size Designators	
Size Designator	Tube O.D. or MNPT, FNPT Size*
1	1/16"
2	1/8"
3	3/16"
4	1/4"
5	5/16"
6	3/8"
8	1/2"
10	5/8"
12	3/4"
16	1"

* Tube O.D. expressed in sixteenths of an inch







CHART #3	
Type of Tube Fitting	Description of Unilok Tube Fitting Types
ANA	AN Adapter
ANBU	AN Bulkhead Union
ANF	Female AN Adapter
ANU	AN Union
BFC	Bulkhead Female Connector
BMC	Bulkhead Male Connector
BR	Bulkhead Reducer/Adapter
BRU	Bulkhead Reducing Union
BU	Bulkhead Union
CP	Cap
CU	Calibration Union
DA	Dielectric Adapter
DU	Dielectric Union
FA	Female Adapter
FBT	Female Branch Tee
FC	Female Connector
FCRT	Female Connector to ISO Tapered
FE	Female Elbow
FRT	Female Run Tee
HBA	Hose Barb Adapter
MA	Male Adapter
MAST	Male Adapter to Straight Thread Boss
MBT	Male Branch Tee
MBTST	Male Branch Tee to Straight Thread Boss
MC	Male Connector
MCBT	Male Connector Bored Through
MCRS	Male Connector to ISO Parallel
MCRT	Male Connector to ISO Tapered
MCST	Male Connector to Straight Thread Boss
ME	Male Elbow
MERT	Male Elbow to ISO Tapered
MEST	Male Elbow to Straight Thread Boss
M45E	Male 45° Elbow
M45EST	Male 45° Elbow to Straight Thread Boss
MPWC	Male Pipe Weld Connector
MPWE	Male Pipe Weld Elbow
MRT	Male Run Tee
MRTST	Male Run Tee to Straight Thread Boss
OMC	O-Ring Seal Male Pipe Connector
OSC	O-Ring Seal Straight Thread Connector
P	Plug
PC	Port Connector
R	Reducer/Adapter
RPC	Reducing Port Connector
RU	Reducing Union
TSWE	Tube Socket Weld Elbow
TSWU	Tube Socket Weld Union
U	Union
UCS	Union Cross
UE	Union Elbow
UT	Union Tee
COMPONENTS	
BN	Bulkhead Nut
KN	Knurled Nut
N	Nut
TI	Tube Insert

Unilok Tube Fittings Selection Guide

Tube to Male Pipe

<p>Male Connector</p>  <p>MC 11</p>	<p>Male Connector to ISO Parallel</p>  <p>MCRS 12</p>
<p>Male Connector to ISO Tapered</p>  <p>MCRT 13</p>	<p>Male Connector Bored Through</p>  <p>MCBT 14</p>
<p>Bulkhead Male Connector</p>  <p>BMC 15</p>	<p>Male Adapter</p>  <p>MA 34</p>
<p>Male Elbow</p>  <p>ME 16</p>	<p>Male Elbow to ISO Tapered</p>  <p>MERT 17</p>
<p>45° Male Elbow</p>  <p>M45E 15</p>	<p>Male Branch Tee</p>  <p>MBT 18</p>
<p>Male Run Tee</p>  <p>MRT 18</p>	









Tube to Female Pipe

<p>Female Connector</p>  <p>FC 19</p>	<p>Bulkhead Female Connector</p>  <p>BFC 20</p>
<p>Female Adapter</p>  <p>FA 35</p>	<p>Female Elbow</p>  <p>FE 22</p>
<p>Female Branch Tee</p>  <p>FBT 23</p>	<p>Female Run Tee</p>  <p>FRT 21</p>







Our selection guide makes it easy to locate any fitting. Simply turn to the page designated in the lower right hand corner.

Unilok Tube Fittings Selection Guide

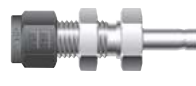



Tube to Tube Union

<p>Union</p>  <p>U 23</p>	<p>Bulkhead Union</p>  <p>BU/BRU 24</p>
<p>Reducing Union</p>  <p>RU 25</p>	<p>Union Elbow</p>  <p>UE 26</p>
<p>Union Tee</p>  <p>UT 27</p>	<p>Reducing Union Tee</p>  <p>RUT 28</p>
<p>Union Cross</p>  <p>UCS 26</p>	<p>Dielectric Adapter / Union</p>  <p>DA/DU 29</p>

Tube Stub Connectors / Adapters



<p>Reducer/Adapter</p>  <p>R 33</p>	<p>Bulkhead Reducer/Adapter</p>  <p>BR 32</p>
<p>Port Connector</p>  <p>PC 36</p>	<p>Reducing Port Connector</p>  <p>RPC 36</p>
<p>Male Adapter</p>  <p>MA 34</p>	<p>Female Adapter</p>  <p>FA 35</p>
<p>Calibration Union</p>  <p>CU 38</p>	<p>Hose Barb Adapter</p>  <p>HBA 37</p>

Tube to Welded Systems

<p>Tube Socket Weld Union</p>  <p>TSWU 30</p>	<p>Tube Socket Weld Elbow</p>  <p>TSWE 30</p>	<p>Male Pipe Weld Connector</p>  <p>MPWC 31</p>	<p>Male Pipe Weld Elbow</p>  <p>MPWE 31</p>
---	---	---	--

Unilok Tube Fittings Selection Guide

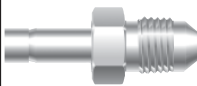

Unilok to 37° Flare (AN)

AN Union 	AN Bulkhead Union 	Female AN Adapter 	AN Adapter 
ANU 39	ANBU 39	ANF 40	ANA 40





Tube to O-Ring Seal & Tube to SAE / MS

O-Ring Seal Male Connector 	O-Ring Seal Straight Connector 	Male Connector to Straight Thread Boss 	Male Elbow to Straight Thread Boss 
OMC 42	OSC 42	MCST 43	MEST 44
45° Male Elbow to Straight Thread Boss 	Male Branch Tee to Straight Thread Boss 	Male Run Tee to Straight Thread Boss 	Male Adapter to Straight Thread Boss 
M45EST 44	MBTST 45	MRTST 45	MAST 46

Cap and Plug

Cap 
CP 47
Plug 
P 47

Components

Nut 	Ferrule 	Knurled Nut 	Bulkhead Locknut 	Tube Insert 
N 48	F 48	KN 49	BN 49	TI 49

Unilok Tube Fittings

DESIGN

Unilok tube fittings are designed and manufactured to provide a reliable, leak-proof connection in instrumentation and process tubing systems. **Unilok** tube fittings consist of three precisely machined components:

- 1) Body
- 2) Ferrule
- 3) Nut

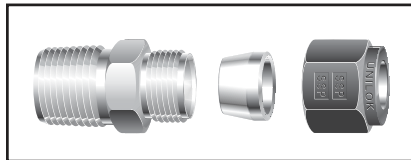

The single ferrule design, with the spring-like action of the ferrule during make-up, compensates for the variations in tubing materials, hardness and thickness of the tube wall to provide leak-tight connections in an extensive range of applications.

Additionally, in fulfillment of the design criteria, all Unilok components are manufactured with extremely tight tolerances and superior surface finishes under rigorous quality control standards to assure the optimum performance of each component part.

OPERATION

Through the critical interaction of the precisely machined fitting components with the process tube, a leak-tight seal is achieved. The simple geometric rotation of the **Unilok** nut provides the axial thrust necessary to coin the ferrule to the outside diameter of the tube. To eliminate any potential stress on an existing system, the tube fittings have been designed to not transmit installation torque from the tube fittings to the tubing.

During the rotary movement of the nut, the internal surface of the nut meets with the rear surface of the ferrule to axially move the ferrule forward into the angular section of the fitting body. The leading edge of the ferrule is directed into the tube to begin the required “bowing” action of the ferrule.

Subsequently, the leading edge of the ferrule “locks” on the outside diameter of the tube to complete the sealing action and secure the tube within the fitting.

The resulting “spring-like action” of the ferrule is designed to help compensate for exposure to system variables such as vibration, pressure pulsation and thermal expansion/contraction.

QUALITY

SSP’s Quality System has been certified to conform to the **ISO 9001:2000 Quality Standard**. Achievement of this prestigious status further confirms SSP’s continuing commitment to quality which is reflected throughout the company in its personnel, policies, equipment, products and service. In addition, all **Unilok** tube fittings are manufactured to the technical design specifications and rigid quality control standards of the SSP Instrumentation Division.

Statistical Process Control techniques are employed within the manufacturing process to



supply timely, meaningful feedback to the production team. Continual process monitoring and equipment control provide the necessary manufacturing quality for **Unilok** instrumentation grade tube fittings.

PACKAGING

Unilok tube fittings are individually bagged to assure the highest levels of quality, safety and cleanliness. The protective bags eliminate contamination (tubing burrs, dirt, etc.) from entering the fitting prior to its use, and help to retain the integrity of the factory assembled body, nut, and ferrule. As long as a **Unilok** tube fitting is in its original protective bag, it is identified as factory new, completely assembled and ready for installation.



The individually bagged **Unilok** tube fittings are packaged in convenient, small-lot quantities for easy procurement and handling.

Additionally, for efficient product identification and storage, the boxes are color-coded to the tube fittings’ material of construction and have pictorial labels which include the part number, product description and box quantity.

Unilok Tube Fittings

MATERIALS

316 STAINLESS STEEL

Unilok straight configuration tube fittings are machined from tube 316 stainless steel cold-finished bar stock in accordance with ASTM A-276 and ASTM A-479. Shaped bodies are machined from close-grained 316 stainless steel forgings in accordance with ASTM A-182. All 316 stainless steel **Unilok** components are heat code traceable with certified material test reports (CMTRs) available.

BRASS

Unilok straight configuration tube fittings are machined from CA360 and CA345 premium brass bar stock in accordance with ASTM B-16 and ASTM B-453. Shaped bodies are machined from precision forgings of CA-377 brass in accordance with ASTM B-124.

PRESSURE RATINGS.

Generally, **Unilok** tube fittings are rated for pressures equal to the maximum allowable working pressures of the tubing recommended for use with the fittings. However, it is important to note that many specially designed fittings, bored-through fittings and fittings having AN, O-Seal and SAE/MS integral ends may have lower pressure ratings than that of the tubing. (See SSP's **Selection Guide for Instrumentation Fittings and Tubing** on pages 50-53 or contact your local Authorized Distributor for more information regarding tubing and fitting pressure ratings.)

TEMPERATURE FACTORS

Unilok tube fittings function reliably in applications ranging from cryogenic temperatures to high temperature bake out with the tube fitting material as the limiting factor. It is important to note that elevated temperatures will reduce the maximum working pressure capability of the tubing system. (For more information regarding the effects of temperature on tubing pressure ratings, refer to Table 5 regarding temperature stress factors in SSP's **Selection Guide for Instrumentation Fittings and Tubing** on pages 50-53.)

GAGEABILITY

Unilok tube fittings are designed, manufactured and quality controlled to be *gageable* for sufficient pull-up during initial installation. See page 9 for additional information.

INTERCHANGEABILITY

Unilok tube fittings are designed, manufactured and quality controlled to be totally "interchangeable" with the Parker CPI™ brand of tube fittings. Component by component examination plainly shows the two brands as completely "component-intermixable." The precision manufacturing of both products to stringent tolerances under rigid quality control procedures ensures the safety, performance and reliability of service whenever **Unilok** and Parker CPI component parts are mixed and used in accordance with published installation and service recommendations.

Additionally, **Unilok** tube fittings are considered able to be "functionally interchangeable" with the Swagelok® brand of tube fitting. "Functionally interchangeable" allows for the use of a **Unilok** nut and/or ferrule with a Swagelok body, or a Swagelok nut and/or ferrule system with a **Unilok** body. The exceptional quality characteristics of both product lines assure complete product performance whenever the two brands are "functionally interchanged."

LIFETIME WARRANTY

Unilok tube fittings are covered by a published Lifetime Warranty as printed on page 54.

TUBE SELECTION

Careful selection and specification of tubing is essential to the performance of a tubing system. When choosing the appropriate tubing material, size and wall thickness, consideration must be given to the system's environment, pressures, temperatures and flows. (For more information on tube selection, please refer to SSP's **Selection Guide for Instrumentation Fittings and Tubing** on pages 50-53.)

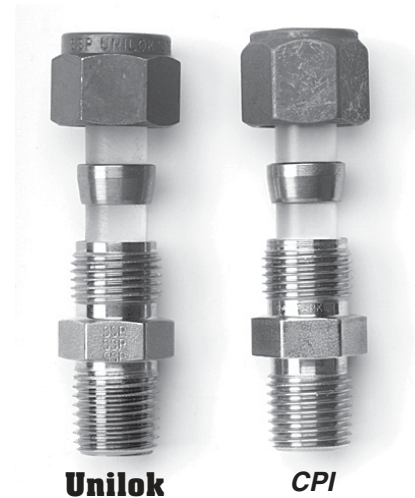

Unilok Installation Instructions

INITIAL INSTALLATION

1. **Unilok** tube fittings come individually bagged and completely assembled for immediate use. There is no need for disassembly prior to use. Simply remove the tube fitting from its bag, insert the tube* until it bottoms in the **Unilok** tube fitting body and then hand tighten the **Unilok** nut. (See Figure #1.)

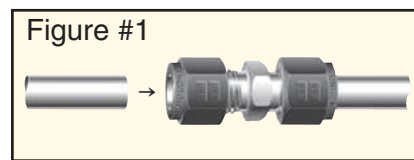

*Tubing ends should be cut as straight as possible with all O.D. and I.D. burrs removed. Use of a tubing cutter or guide blocks with a hacksaw is recommended.

*NOTE: For extreme system applications using high pressures or requiring an extra factor of safety, it may be desirable to use a "common makeup starting point" to alleviate the inherent variations in tubing diameters. Installation should begin from a "snug" position, which is achieved by wrench tightening the **Unilok** nut until the inserted tubing will not move freely by hand (approximately 1/8 turn). From this new "snug" starting point, continue with the recommended installation instructions.*

2. While holding the fitting body stable with a back-up wrench, scribe the nut for a reference point and wrench tighten the nut 1-1/4 turns for sizes 1/4" - 1" and 3/4 turn for sizes 1/16"-3/16". (See Figures #2 and #3.)

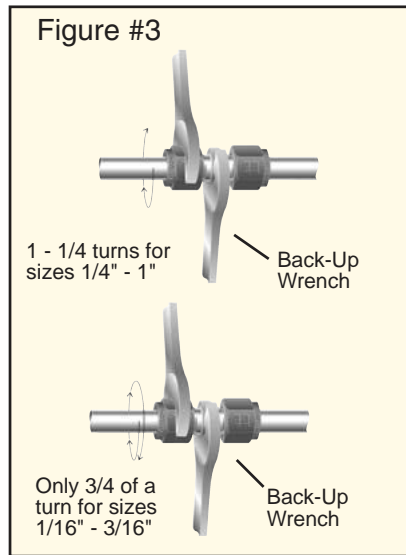
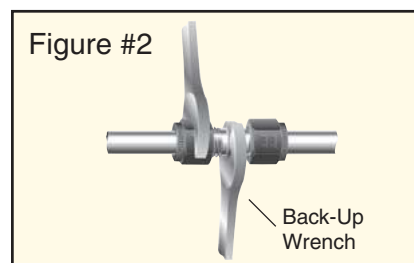

*Note: For all sizes, tighten plugs (P), machined ferrule end of port connector (PC) and the **Unilok** end of the Female AN Adapter (ANF) only 1/4 of a turn.*

REASSEMBLY INSTRUCTIONS

1. To reassemble a **Unilok** tube fitting connection, simply insert the tubing with the previously swaged ferrule and **Unilok** nut into the fitting body until the ferrule seats within the fitting body, and then tighten the nut by hand. (See Figure #4.)

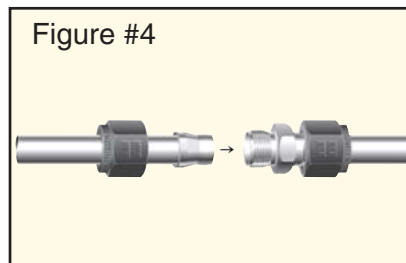

*NOTE: By following proper reassembly procedures, **Unilok** tube fitting connections may be disconnected and reconnected repeatedly.*

2. While holding the fitting body stable with a back-up wrench, use a wrench to rotate the **Unilok** nut to the fitting's original installation position (approximately 1/4 turn from the hand-tight, snug position) then continue to tighten the **Unilok** nut slightly. (See Figure #5.)

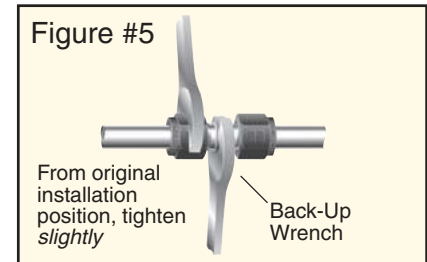

COMPONENT ASSEMBLY

Should individual component assembly of a **Unilok** tube fitting ever be required, careful attention must be given to the proper sequence and direction of the **Unilok** components. (See Figure #6.)

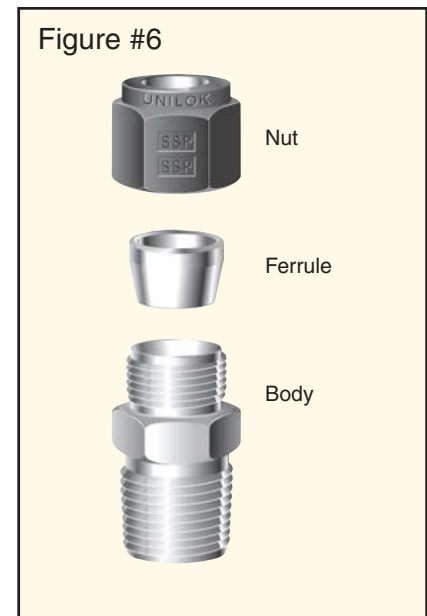

Pre-setting Tool/Gap Gage

The **Unilok** pre-setting tool is used to pre-set the ferrule on the tubing for subsequent installation in a fitting body. The pre-setting tool can be especially helpful when an installation must be made in a tight space or hard-to-work area. The pre-setting tool allows the major portion of the installation work to occur in a more favorable work setting with only the completion of the installation in the hard-to-work area.

PRE-SETTING INSTRUCTIONS

1. Secure the pre-setting tool in a vice.
2. Remove the protective nut, and assemble the **Unilok** nut and ferrule loosely to the pre-setting tool. Insert the tubing through the nut and ferrule until it bottoms in the pre-setting tool, and then follow the standard **Unilok** tube fitting installation instructions from page 9. (See Figures #7A and #7B.)

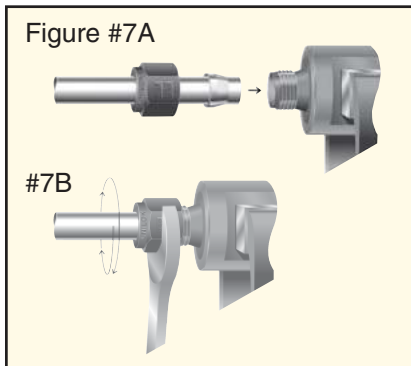

3. Loosen the nut and remove the tubing with the pre-set **Unilok** ferrule and nut from the pre-setting tool. (See Figure #8.) Return the protective nut to the pre-setting tool.

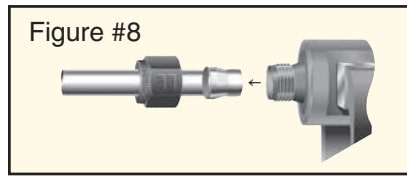

4. Installation of the tubing, with the pre-set **Unilok** ferrule and nut in the appropriate fitting body, can now be made by following the standard reassembly instructions from page 9. (See Figures #9A and #9B.)

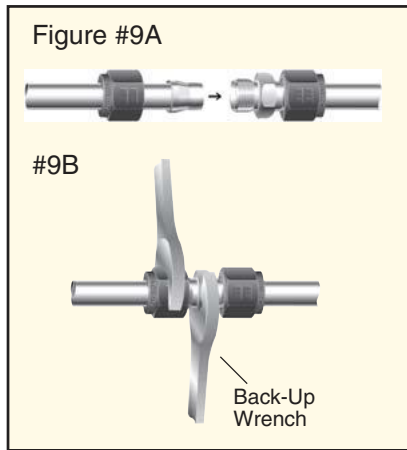

NOTE: To extend the life of a pre-setting tool, lubricate the tool with a lubricant compatible with the system's tubing material, environment and media. Also, at times, an oversized or very soft tubing may tend to stick in the pre-setting tool after make up. To remove the tubing, gently rock the tube back and forth. Never turn the tube with pliers or another tool, as such action may damage the sealing surfaces.

GAGEABILITY

Each **Unilok** tube fitting component is manufactured with utmost precision to provide the optimum performance interaction of the components during assembly. By maintaining such stringent manufacturing tolerances, **Unilok** tube fittings are considered **gageable** for sufficient pull-up during initial installation. The

Unilok "Gap Gages" are designed to identify for the installer or inspector, prior to pressurizing a system, that sufficient tightening of the tube fitting has occurred. **Gageability** provides additional reliability for proper installation and ultimate tube fitting safety and performance.

UNILOK GAP GAGE INSTRUCTIONS

1. Follow proper installation instructions (as supplied with the fittings, or published in the **Unilok** catalog).
2. After completion of the installation instructions and prior to pressuring the system, choose the proper size Gap Gage and try to insert it between the fitting's nut and body hex. (See Figure #10.)

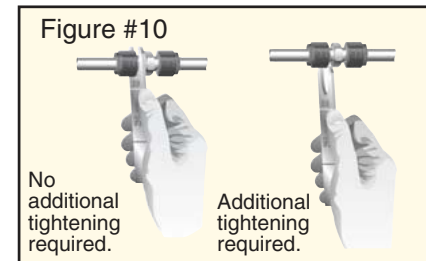

3. If the Gap Gage will not enter between the fitting's nut and body hex, no additional tightening is required.
4. If the Gap Gage will enter between the fitting's nut and body hex, additional tightening is required.

NOTE: Parker CPI Inspection Gauges may also be utilized effectively with Unilok tube fittings.

ORDERING INFORMATION

To order **Unilok** pre-setting tools and gap gages, contact your authorized SSP Instrumentation distributor.

Tube to Male Pipe

MC

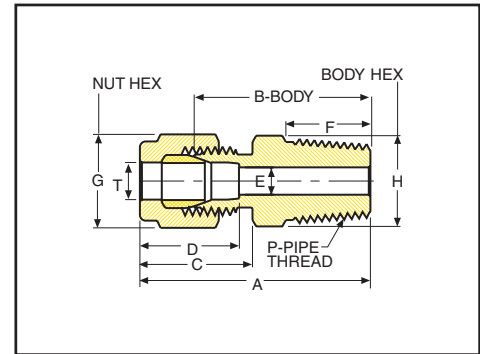

Male Connector

Unilok Part #	T Tube O.D.	P-NPT Male Pipe Size	A	B	C	D	E Minimum Opening	F Min.	G	H
U1MC1	1/16	1/16	0.94	0.79	0.43	0.34	0.05	0.38	5/16	5/16
U1MC2	1/16	1/8	1.03	0.88	0.43	0.34	0.05	0.38	5/16	7/16
U1MC4	1/16	1/4	1.22	1.07	0.43	0.34	0.05	0.56	5/16	9/16
U2MC1	1/8	1/16	1.17	0.91	0.60	0.50	0.09	0.38	7/16	7/16
U2MC2	1/8	1/8	1.20	0.94	0.60	0.50	0.09	0.38	7/16	7/16
U2MC4	1/8	1/4	1.40	1.14	0.60	0.50	0.09	0.56	7/16	9/16
U2MC6	1/8	3/8	1.41	1.15	0.60	0.50	0.09	0.56	7/16	11/16
U2MC8	1/8	1/2	1.66	1.40	0.60	0.50	0.09	0.75	7/16	7/8
U3MC2	3/16	1/8	1.23	0.97	0.63	0.54	0.12	0.38	1/2	7/16
U3MC4	3/16	1/4	1.43	1.17	0.63	0.54	0.12	0.56	1/2	9/16
U4MC1	1/4	1/16	1.29	1.00	0.70	0.60	0.11	0.38	9/16	1/2
U4MC2	1/4	1/8	1.29	1.00	0.70	0.60	0.19	0.38	9/16	1/2
U4MC4	1/4	1/4	1.49	1.20	0.70	0.60	0.19	0.56	9/16	9/16
U4MC6	1/4	3/8	1.51	1.22	0.70	0.60	0.19	0.56	9/16	11/16
U4MC8	1/4	1/2	1.76	1.47	0.70	0.60	0.19	0.75	9/16	7/8
U4MC12	1/4	3/4	1.82	1.53	0.70	0.60	0.19	0.75	9/16	11/16
U5MC2	5/16	1/8	1.34	1.05	0.73	0.64	0.19	0.38	5/8	9/16
U5MC4	5/16	1/4	1.52	1.23	0.73	0.64	0.25	0.56	5/8	9/16
U5MC6	5/16	3/8	1.54	1.25	0.73	0.64	0.25	0.56	5/8	11/16
U6MC2	3/8	1/8	1.39	1.10	0.76	0.66	0.19	0.38	11/16	5/8
U6MC4	3/8	1/4	1.57	1.28	0.76	0.66	0.28	0.56	11/16	5/8
U6MC6	3/8	3/8	1.57	1.28	0.76	0.66	0.28	0.56	11/16	1-1/16
U6MC8	3/8	1/2	1.82	1.53	0.76	0.66	0.28	0.75	11/16	7/8
U6MC12	3/8	3/4	1.88	1.59	0.76	0.66	0.28	0.75	11/16	11/16
U8MC2	1/2	1/8	1.53	1.13	0.86	0.90	0.19	0.38	7/8	13/16
U8MC4	1/2	1/4	1.71	1.31	0.86	0.90	0.28	0.56	7/8	13/16
U8MC6	1/2	3/8	1.71	1.31	0.86	0.90	0.38	0.56	7/8	13/16
U8MC8	1/2	1/2	1.93	1.53	0.86	0.90	0.41	0.75	7/8	7/8
U8MC12	1/2	3/4	1.99	1.59	0.86	0.90	0.41	0.75	7/8	1-1/16
U8MC16	1/2	1	2.25	1.85	0.86	0.90	0.41	0.94	7/8	1-3/8
U10MC6	5/8	3/8	1.74	1.34	0.86	0.96	0.38	0.56	1	15/16
U10MC8	5/8	1/2	1.93	1.53	0.86	0.96	0.47	0.75	1	15/16
U10MC12	5/8	3/4	1.99	1.59	0.86	0.96	0.50	0.75	1	1-1/16
U12MC8	3/4	1/2	1.99	1.59	0.86	0.96	0.47	0.75	1-1/8	1-1/16
U12MC12	3/4	3/4	1.99	1.59	0.86	0.96	0.62	0.75	1-1/8	1-1/16
U12MC16	3/4	1	2.25	1.85	0.86	0.96	0.62	0.94	1-1/8	1-3/8
U14MC12	7/8	3/4	1.99	1.59	0.86	1.02	0.62	0.75	1-1/4	1-3/16
U14MC16	7/8	1	2.25	1.85	0.86	1.02	0.72	0.94	1-1/4	1-3/8
U16MC8	1	1/2	2.26	1.78	1.04	1.23	0.47	0.75	1-1/2	1-3/8
U16MC12	1	3/4	2.26	1.78	1.04	1.23	0.62	0.75	1-1/2	1-3/8
U16MC16	1	1	2.45	1.97	1.04	1.23	0.88	0.94	1-1/2	1-3/8

Finger-tight assembly dimensions (shown in inches) are for reference only and subject to change.

When ordering, specify material designator with part number (see page 3 for complete ordering information).

Tube to Male Pipe

MCRS

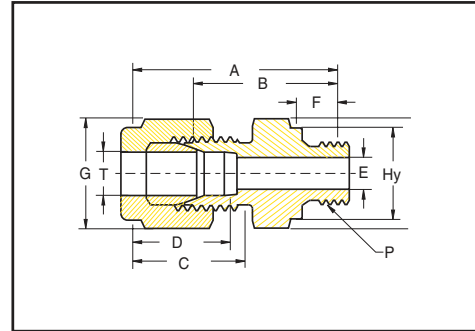
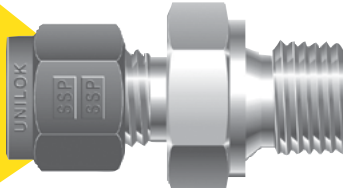

Male Connector - ISO Parallel

Unilok Part#	T Tube O.D.	P ISO Male Pipe	A	F	C	D	E	H Body Hex	Hy	G Nut Hex	B Body
U2MCRS2	1/8	1/8	1.18	0.28	0.60	0.50	0.09	9/16	0.54	7/16	0.92
U2MCRS4	1/8	1/4	1.39	0.44	0.60	0.50	0.09	3/4	0.71	7/16	1.13
U2MCRS6	1/8	3/8	1.43	0.44	0.60	0.50	0.09	7/8	0.86	7/16	1.17
U4MCRS2	1/4	1/8	1.27	0.28	0.70	0.60	0.16	9/16	0.54	9/16	0.98
U4MCRS4	1/4	1/4	1.48	0.44	0.70	0.60	0.19	3/4	0.71	9/16	1.19
U4MCRS6	1/4	3/8	1.53	0.44	0.70	0.60	0.19	7/8	0.86	9/16	1.24
U4MCRS8	1/4	1/2	1.76	0.56	0.70	0.60	0.19	1-1/16	1.02	9/16	1.47
U6MCRS4	3/8	1/4	1.54	0.44	0.76	0.66	0.23	3/4	0.71	11/16	1.25
U6MCRS6	3/8	3/8	1.59	0.44	0.76	0.66	0.28	7/8	0.86	11/16	1.30
U6MCRS8	3/8	1/2	1.82	0.56	0.76	0.66	0.28	1-1/16	1.02	11/16	1.53
U8MCRS4	1/2	1/4	1.68	0.44	0.86	0.90	0.23	13/16	0.71	7/8	1.28
U8MCRS6	1/2	3/8	1.70	0.44	0.86	0.90	0.31	7/8	0.86	7/8	1.30
U8MCRS8	1/2	1/2	1.93	0.56	0.86	0.90	0.41	1-1/16	1.02	7/8	1.53
U12MCRS8	3/4	1/2	1.93	0.56	0.86	0.96	0.47	1-1/16	1.02	1-1/8	1.53
U12MCRS12	3/4	3/4	2.08	0.62	0.86	0.96	0.62	1-5/16	1.26	1-1/8	1.68
U16MCRS8	1	1/2	2.20	0.56	1.04	1.23	0.47	1-3/8	1.02	1-1/2	1.72
U16MCRS16	1	1	2.36	0.72	1.04	1.23	0.78	1-5/8	1.54	1-1/2	1.88

NOTE: RS threaded fittings conform to ISO (International Standards Organization) standards 228/1. The standard gasket for RS fittings is a composite gasket. This gasket features a 300 series stainless steel outer ring with a Buna inner ring bonded to it.

Unilok tube fittings are designed and manufactured to provide safe, reliable leak free tubing connections.

Tube to Male Pipe

MCRT

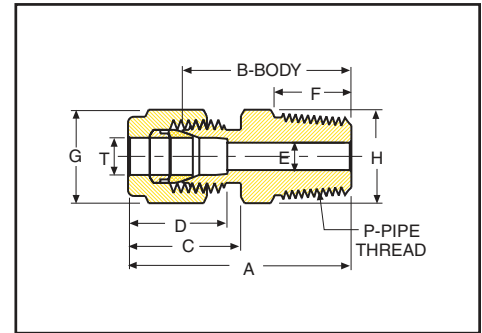
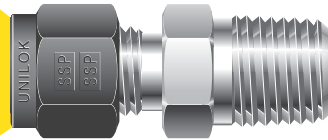

Male Connector - ISO Tapered

Unilok Part#	T Tube O.D.	P ISO Male Pipe	A	F	C	D	E Min. Opening	H Hex Flat	G Hex Flat	B Body
U2MCRT2	1/8	1/8	1.20	0.38	0.60	0.50	0.09	7/16	7/16	0.94
U2MCRT4	1/8	1/4	1.40	0.56	0.60	0.50	0.09	9/16	7/16	1.14
U4MCRT2	1/4	1/8	1.29	0.38	0.70	0.60	0.19	1/2	9/16	1.00
U4MCRT4	1/4	1/4	1.49	0.56	0.70	0.60	0.19	9/16	9/16	1.20
U4MCRT6	1/4	3/8	1.51	0.56	0.70	0.60	0.19	11/16	9/16	1.22
U4MCRT8	1/4	1/2	1.76	0.75	0.70	0.60	0.19	7/8	9/16	1.47
U5MCRT2	5/16	1/8	1.34	0.38	0.73	0.64	0.19	9/16	5/8	1.05
U5MCRT4	5/16	1/4	1.52	0.56	0.73	0.64	0.25	9/16	5/8	1.23
U6MCRT2	3/8	1/8	1.39	0.38	0.76	0.66	0.19	5/8	11/16	1.10
U6MCRT4	3/8	1/4	1.57	0.56	0.76	0.66	0.28	5/8	11/16	1.28
U6MCRT6	3/8	3/8	1.57	0.56	0.76	0.66	0.28	11/16	11/16	1.28
U6MCRT8	3/8	1/2	1.82	0.75	0.76	0.66	0.28	7/8	11/16	1.53
U8MCRT4	1/2	1/4	1.71	0.56	0.86	0.90	0.28	13/16	7/8	1.31
U8MCRT6	1/2	3/8	1.71	0.56	0.86	0.90	0.38	13/16	7/8	1.31
U8MCRT8	1/2	1/2	1.93	0.75	0.86	0.90	0.41	7/8	7/8	1.53
U8MCRT12	1/2	3/4	1.99	0.75	0.86	0.90	0.41	1-1/16	7/8	1.59
U12MCRT12	3/4	3/4	1.99	0.75	0.86	0.96	0.62	1-1/16	1-1/8	1.59
U16MCRT16	1	1	2.45	0.94	1.04	1.23	0.88	1-3/8	1-1/2	1.97

NOTE: RT threaded fittings conform to ISO (International Standards Organization) standards 7/1.

Tube to Male Pipe

MCBT

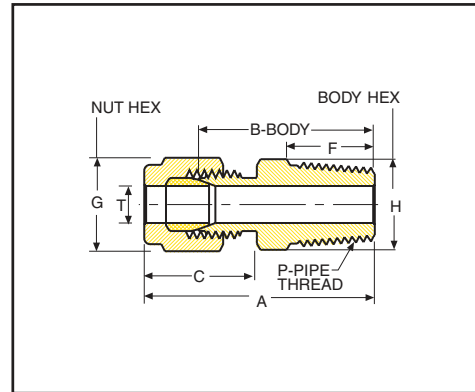

Male Connector - Bored Through

Unilok Part #	T Tube O.D.	P-NPT Male Pipe Size	A	B	C	F Min.	G	H
U1MCBT1	1/16	1/16	0.98	0.79	0.47	0.38	5/16	5/16
U1MCBT2	1/16	1/8	1.07	0.88	0.47	0.38	5/16	7/16
U2MCBT1	1/8	1/16	1.18	0.91	0.61	0.38	7/16	7/16
U2MCBT2	1/8	1/8	1.21	0.94	0.61	0.38	7/16	7/16
U2MCBT4	1/8	1/4	1.41	1.14	0.61	0.56	7/16	9/16
U3MCBT2	3/16	1/8	1.25	0.97	0.65	0.38	1/2	7/16
U3MCBT4	3/16	1/4	1.45	1.17	0.65	0.56	1/2	9/16
U4MCBT2	1/4	1/8	1.29	1.00	0.70	0.38	9/16	1/2
U4MCBT4	1/4	1/4	1.49	1.20	0.70	0.56	9/16	9/16
U4MCBT6	1/4	3/8	1.51	1.22	0.70	0.56	9/16	11/16
U4MCBT8	1/4	1/2	1.76	1.47	0.70	0.75	9/16	7/8
U5MCBT4	5/16	1/4	1.54	1.23	0.75	0.56	5/8	9/16
U6MCBT4	3/8	1/4	1.59	1.28	0.78	0.56	11/16	5/8
U6MCBT6	3/8	3/8	1.59	1.28	0.78	0.56	11/16	11/16
U6MCBT8	3/8	1/2	1.84	1.53	0.78	0.75	11/16	7/8
U8MCBT8	1/2	1/2	1.97	1.53	0.90	0.75	7/8	7/8
U10MCBT12	5/8	3/4	2.01	1.59	0.88	0.75	1	1-1/16
U12MCBT12	3/4	3/4	2.01	1.59	0.88	0.75	1-1/8	1-1/16
U16MCBT16	1	1	2.46	1.97	1.05	0.94	1-1/2	1-3/8

Thermocouple Connector

To accommodate thermocouples and other sensing probes, the MCBT series of fittings has been “bored through” to allow the thermocouple or sensor to extend beyond the end of the fitting’s NPT thread.

Note: Pressure Ratings of “bored through” tube fittings are reduced.
For additional information on a specific fitting’s rating, contact the local distributor.

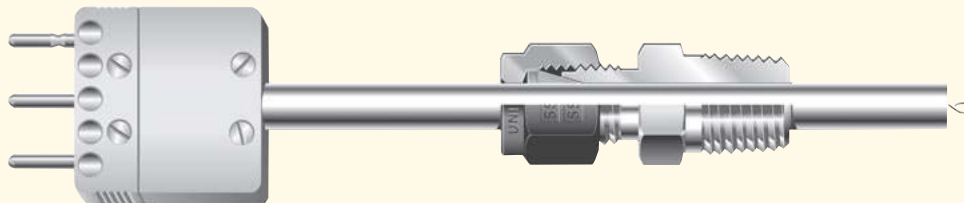

Finger-tight assembly dimensions (shown in inches) are for reference only and subject to change.

When ordering, specify material designator with part number (see page 3 for complete ordering information).

Tube to Male Pipe

BMC

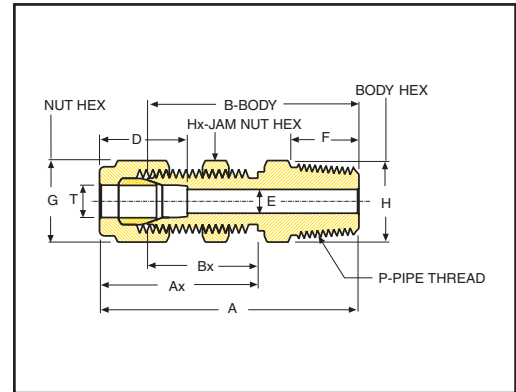
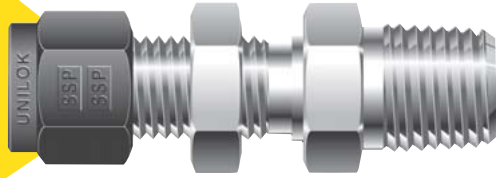

Bulkhead Male Connector

Unilok Part #	T tube O.D.	P-NPT Male Pipe Size	A	Ax	B	Bx	D	E Minimum Opening	F Min.	G	H	Hx	Maximum Panel Thickness	Panel Hole Drill Size
U2BMC2	1/8	1/8	1.83	1.23	1.57	0.97	0.50	0.09	0.38	7/16	1/2	1/2	0.50	21/64
U4BMC2	1/4	1/8	1.95	1.32	1.66	1.03	0.60	0.17	0.38	9/16	5/8	5/8	0.40	29/64
U4BMC4	1/4	1/4	2.10	1.32	1.81	1.03	0.60	0.19	0.56	9/16	5/8	5/8	0.40	29/64
U6BMC4	3/8	1/4	2.26	1.45	1.97	1.16	0.66	0.28	0.56	11/16	3/4	3/4	0.44	37/64
U8BMC6	1/2	3/8	2.49	1.65	2.09	1.25	0.90	0.37	0.56	7/8	15/16	15/16	0.50	49/64
U8BMC8	1/2	1/2	2.71	1.65	2.31	1.25	0.90	0.41	0.75	7/8	15/16	15/16	0.50	49/64

M45E

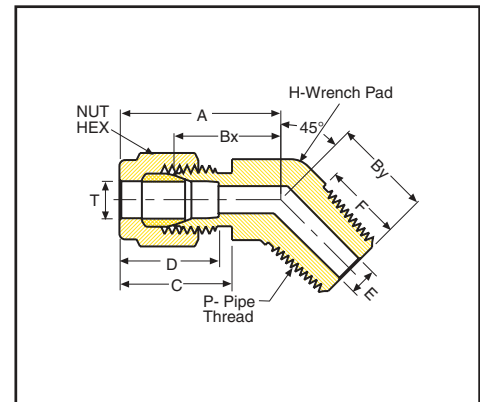

45° Male Elbow

Unilok Part #	T Tube O.D.	P-NPT Male Pipe Size	A	Bx	By	C	U	E Minimum Opening	F Min.	G	H
U4M45E2	1/4	1/8	0.97	0.68	0.65	0.70	0.60	0.17	0.38	9/16	9/16
U4M45E4	1/4	1/4	0.97	0.68	0.83	0.70	0.60	0.19	0.56	9/16	9/16
U6M45E2	3/8	1/8	1.10	0.81	0.72	0.76	0.66	0.19	0.38	11/16	5/8
U6M45E4	3/8	1/4	1.10	0.81	0.90	0.76	0.66	0.28	0.56	11/16	5/8
U6M45E6	3/8	3/8	1.15	0.86	0.95	0.76	0.66	0.28	0.56	11/16	3/4
U8M45E6	1/2	3/8	1.26	0.86	0.95	0.86	0.90	0.38	0.56	7/8	13/16

Finger-tight assembly dimensions (shown in inches) are for reference only and subject to change.

When ordering, specify material designator with part number (see page 3 for complete ordering information).

Tube to Male Pipe

ME

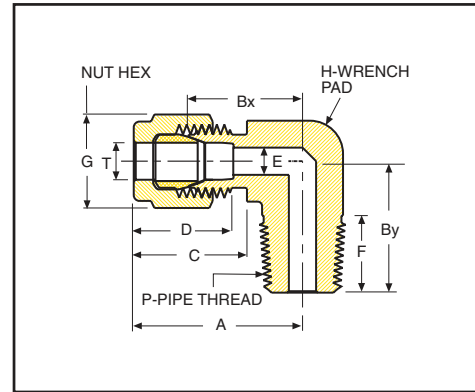
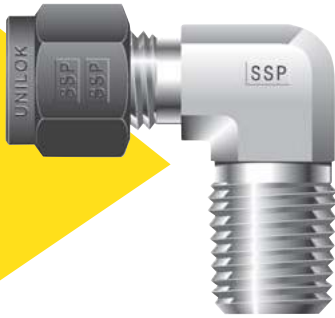

Male Elbow

Unilok Part #	T Tube O.D.	P-NPT Male Pipe Size	A	Bx	By	C	U	E Minimum Opening	F Min.	G	H
U1ME1	1/16	1/16	0.75	0.60	0.70	0.43	0.34	0.05	0.38	5/16	7/16
U1ME2	1/16	1/8	0.75	0.60	0.70	0.43	0.34	0.05	0.38	5/16	1/2
U2ME1	1/8	1/16	0.93	0.67	0.70	0.60	0.50	0.09	0.38	7/16	7/16
U2ME2	1/8	1/8	0.93	0.67	0.70	0.60	0.50	0.09	0.38	7/16	7/16
U2ME4	1/8	1/4	0.97	0.71	0.92	0.60	0.50	0.09	0.56	7/16	1/2
U3ME2	3/16	1/8	1.00	0.74	0.74	0.63	0.54	0.12	0.38	1/2	1/2
U3ME4	3/16	1/4	1.00	0.74	0.92	0.63	0.54	0.12	0.56	1/2	1/2
U4ME2	1/4	1/8	1.06	0.77	0.74	0.70	0.60	0.17	0.38	9/16	1/2
U4ME4	1/4	1/4	1.06	0.77	0.92	0.70	0.60	0.19	0.56	9/16	1/2
U4ME6	1/4	3/8	1.17	0.88	1.03	0.70	0.60	0.19	0.56	9/16	11/16
U4ME8	1/4	1/2	1.25	0.96	1.30	0.70	0.60	0.19	0.75	9/16	7/8
U5ME2	5/16	1/8	1.13	0.84	0.78	0.73	0.64	0.19	0.38	5/8	9/16
U5ME4	5/16	1/4	1.13	0.84	0.96	0.73	0.64	0.25	0.56	5/8	9/16
U5ME6	5/16	3/8	1.20	0.91	1.03	0.73	0.64	0.25	0.56	5/8	11/16
U6ME2	3/8	1/8	1.20	0.91	0.82	0.76	0.66	0.19	0.38	11/16	5/8
U6ME4	3/8	1/4	1.20	0.91	1.00	0.76	0.66	0.28	0.56	11/16	5/8
U6ME6	3/8	3/8	1.23	0.94	1.03	0.76	0.66	0.28	0.56	11/16	11/16
U6ME8	3/8	1/2	1.31	1.02	1.30	0.76	0.66	0.28	0.75	11/16	7/8
U6ME12	3/8	3/4	1.46	1.17	1.45	0.76	0.66	0.28	0.75	11/16	1-1/16
U8ME4	1/2	1/4	1.42	1.02	1.11	0.86	0.90	0.28	0.56	7/8	13/16
U8ME6	1/2	3/8	1.42	1.02	1.11	0.86	0.90	0.38	0.56	7/8	13/16
U8ME8	1/2	1/2	1.42	1.02	1.30	0.86	0.90	0.41	0.75	7/8	7/8
U8ME12	1/2	3/4	1.57	1.17	1.45	0.86	0.90	0.41	0.75	7/8	1-1/16
U10ME6	5/8	3/8	1.50	1.10	1.19	0.86	0.96	0.38	0.56	1	15/16
U10ME8	5/8	1/2	1.50	1.10	1.38	0.86	0.96	0.47	0.75	1	15/16
U10ME12	5/8	3/4	1.57	1.17	1.45	0.86	0.96	0.50	0.75	1	1-1/16
U12ME8	3/4	1/2	1.57	1.17	1.45	0.86	0.96	0.47	0.75	1-1/8	1-1/16
U12ME12	3/4	3/4	1.57	1.17	1.45	0.86	0.96	0.62	0.75	1-1/8	1-1/16
U14ME12	7/8	3/4	1.76	1.36	1.64	0.86	1.02	0.62	0.75	1-1/4	1-3/8
U16ME12	1	3/4	1.93	1.45	1.64	1.04	1.23	0.62	0.75	1-1/2	1-3/8
U16ME16	1	1	1.93	1.45	1.83	1.04	1.23	0.88	0.75	1-1/2	1-3/8

Finger-tight assembly dimensions (shown in inches) are for reference only and subject to change.

When ordering, specify material designator with part number (see page 3 for complete ordering information).

Tube to Male Pipe

MERT

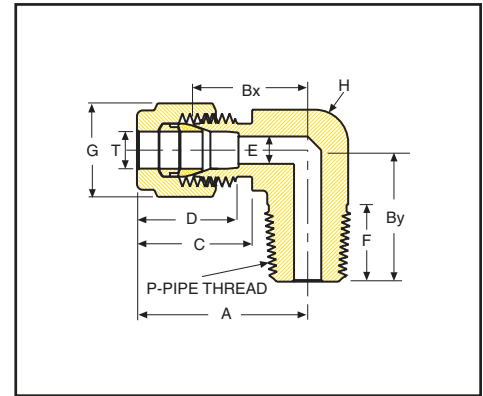
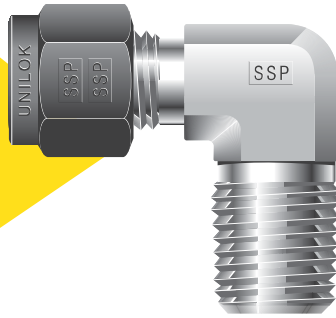

Male Elbow - ISO Tapered

Unilok Part#	T Tube O.D.	P ISO Male Pipe	A	F	C	D	E Min. Opening	H Wrench Pad	G Hex Flat	Bx	By
U2MERT2	1/8	1/8	.093	0.38	0.60	0.50	0.09	7/16	7/16	0.67	0.70
U4MERT2	1/4	1/8	1.06	0.38	0.70	0.60	0.19	1/2	9/16	0.77	0.74
U4MERT4	1/4	1/4	1.06	0.56	0.70	0.60	0.19	1/2	9/16	0.77	0.92
U4MERT6	1/4	3/8	1.17	0.56	0.70	0.60	0.19	11/16	9/16	0.88	1.03
U4MERT8	1/4	1/2	1.25	0.75	0.70	0.60	0.19	13/16	9/16	0.96	1.30
U5MERT4	5/16	1/4	1.13	0.56	0.73	0.64	0.25	9/16	5/8	0.84	0.96
U6MERT2	3/8	1/8	1.20	0.38	0.76	0.66	0.19	5/8	11/16	0.91	0.82
U6MERT4	3/8	1/4	1.20	0.56	0.76	0.66	0.28	5/8	11/16	0.91	1.00
U6MERT6	3/8	3/8	1.23	0.56	0.76	0.66	0.28	11/16	11/16	0.94	1.03
U6MERT8	3/8	1/2	1.31	0.75	0.76	0.66	0.28	13/16	11/16	1.02	1.30
U8MERT4	1/2	1/4	1.42	0.56	0.86	0.90	0.28	13/16	7/8	1.02	1.11
U8MERT6	1/2	3/8	1.42	0.56	0.86	0.90	0.38	13/16	7/8	1.02	1.11
U8MERT8	1/2	1/2	1.42	0.75	0.86	0.90	0.41	13/16	7/8	1.02	1.30

NOTE: RT threaded fittings conform to ISO (International Standards Organization) standards 7/1.

Always specify genuine Unilok tube fittings.

Tube to Male Pipe

MBT

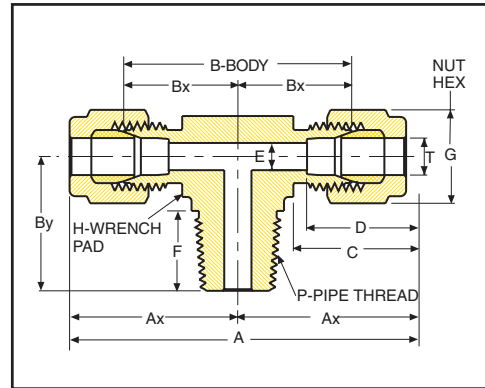
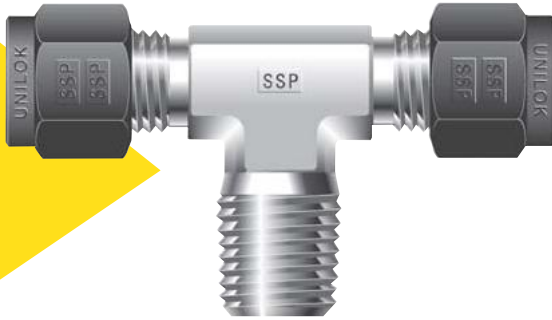

Male Branch Tee

Unilok Part #	T Tube O.D.	P-NPT Male Pipe Size	A	Ax	B	Bx	By	C	U	E Minimum Opening	F Min.	G	H
U2MBT2	1/8	1/8	1.86	0.93	1.34	0.67	0.70	0.60	0.50	0.09	0.38	7/16	7/16
U2MBT4	1/8	1/4	1.94	0.97	1.42	0.71	0.92	0.60	0.50	0.09	0.56	7/16	9/16
U3MBT2	3/16	1/8	1.92	0.96	1.40	0.70	0.70	0.63	0.54	0.12	0.38	1/2	7/16
U4MBT2	1/4	1/8	2.12	1.06	1.54	0.77	0.74	0.70	0.60	0.17	0.38	9/16	1/2
U4MBT4	1/4	1/4	2.12	1.06	1.54	0.77	0.92	0.70	0.60	0.17	0.56	9/16	9/16
U5MBT2	5/16	1/8	2.34	1.17	1.76	0.88	0.82	0.73	0.64	0.19	0.38	5/8	5/8
U6MBT4	3/8	1/4	2.40	1.20	1.82	0.91	1.00	0.76	0.66	0.28	0.56	11/16	5/8
U6MBT6	3/8	3/8	2.62	1.31	2.04	1.02	1.11	0.76	0.66	0.28	0.56	11/16	13/16
U8MBT6	1/2	3/8	2.84	1.42	2.04	1.02	1.11	0.86	0.90	0.38	0.56	7/8	13/16
U8MBT8	1/2	1/2	2.84	1.42	2.04	1.02	1.30	0.86	0.90	0.41	0.75	7/8	7/8
U10MBT8	5/8	1/2	3.06	1.53	2.26	1.13	1.41	0.86	0.96	0.47	0.75	1	1
U12MBT12	3/4	3/4	3.14	1.57	2.34	1.17	1.45	0.86	0.96	0.62	0.75	1-1/8	1-1/16

MRT

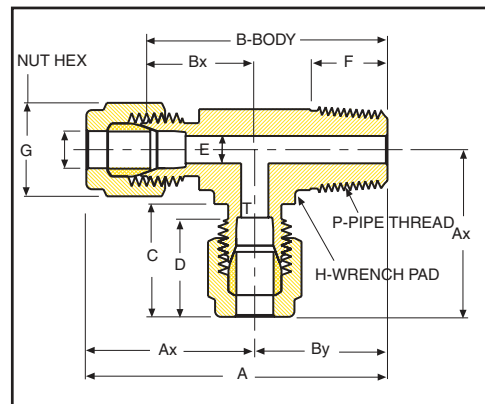
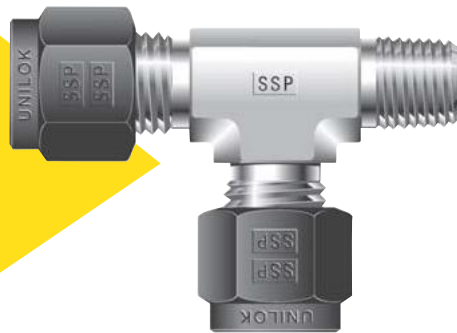

Male Run Tee

Unilok Part #	T Tube O.D.	P-NPT Male Pipe Size	A	Ax	B	Bx	By	C	D	E Minimum Opening	F Min.	G	H
U2MRT2	1/8	1/8	1.63	0.93	1.37	0.67	0.70	0.60	0.50	0.09	0.38	7/16	7/16
U2MRT4	1/8	1/4	1.89	0.97	1.63	0.71	0.92	0.60	0.50	0.09	0.56	7/16	9/16
U3MRT2	3/16	1/8	1.66	0.96	1.40	0.70	0.70	0.63	0.54	0.12	0.38	1/2	7/16
U4MRT2	1/4	1/8	1.80	1.06	1.51	0.77	0.74	0.70	0.60	0.17	0.38	9/16	1/2
U4MRT4	1/4	1/4	1.98	1.06	1.69	0.77	0.92	0.70	0.60	0.19	0.56	9/16	9/16
U5MRT2	5/16	1/8	1.99	1.17	1.70	0.88	0.82	0.73	0.64	0.19	0.38	5/8	5/8
U6MRT4	3/8	1/4	2.20	1.20	1.91	0.91	1.00	0.76	0.66	0.28	0.56	11/16	5/8
U6MRT6	3/8	3/8	2.42	1.31	2.13	1.02	1.11	0.76	0.66	0.28	0.56	11/16	13/16
U8MRT6	1/2	3/8	2.53	1.42	2.13	1.02	1.11	0.86	0.90	0.38	0.56	7/8	13/16
U8MRT8	1/2	1/2	2.72	1.42	2.32	1.02	1.30	0.86	0.90	0.41	0.75	7/8	7/8
U10MRT8	5/8	1/2	2.88	1.50	2.48	1.10	1.38	0.86	0.96	0.47	0.75	1	1
U12MRT12	3/4	3/4	3.02	1.57	2.62	1.17	1.45	0.86	0.96	0.62	0.75	1-1/8	1-1/16

Finger-tight assembly dimensions (shown in inches) are for reference only and subject to change.

When ordering, specify material designator with part number (see page 3 for complete ordering information).

Tube to Female Pipe

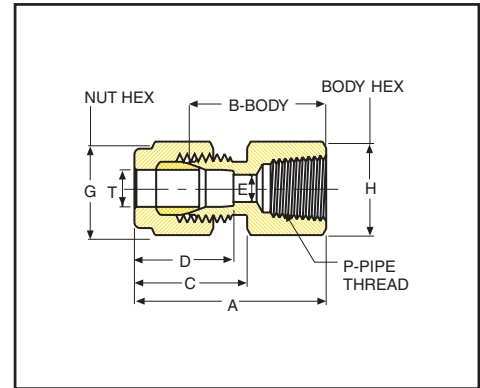
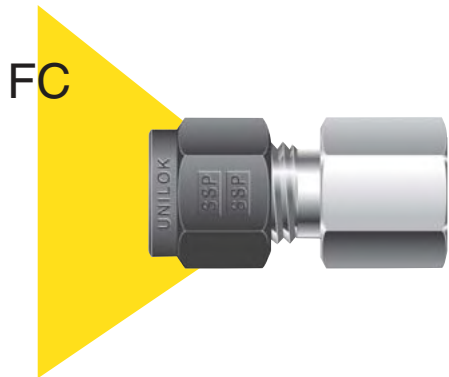

Female Connector

Unilok Part #	T Tube O.D.	P-NPT Female Pipe Size	A	B	C	D	E Minimum Opening	G	H
U1FC1	1/16	1/16	0.93	0.78	0.43	0.34	0.05	5/16	7/16
U1FC2	1/16	1/8	0.96	0.81	0.43	0.34	0.05	5/16	9/16
U2FC2	1/8	1/8	1.13	0.87	0.60	0.50	0.09	7/16	9/16
U2FC4	1/8	1/4	1.32	1.06	0.60	0.50	0.09	7/16	3/4
U3FC2	3/16	1/8	1.17	0.91	0.63	0.54	0.12	1/2	9/16
U4FC2	1/4	1/8	1.23	0.94	0.70	0.60	0.19	9/16	9/16
U4FC4	1/4	1/4	1.41	1.12	0.70	0.60	0.19	9/16	3/4
U4FC6	1/4	3/8	1.48	1.19	0.70	0.60	0.19	9/16	7/8
U4FC8	1/4	1/2	1.67	1.38	0.70	0.60	0.19	9/16	1 1/16
U5FC2	5/16	1/8	1.26	0.97	0.73	0.64	0.25	5/8	9/16
U5FC4	5/16	1/4	1.45	1.16	0.73	0.64	0.25	5/8	3/4
U6FC2	3/8	1/8	1.29	1.00	0.76	0.66	0.28	11/16	5/8
U6FC4	3/8	1/4	1.48	1.19	0.76	0.66	0.28	11/16	3/4
U6FC6	3/8	3/8	1.54	1.25	0.76	0.66	0.28	11/16	7/8
U6FC8	3/8	1/2	1.73	1.44	0.76	0.66	0.28	11/16	1-1/16
U6FC12	3/8	3/4	1.88	1.59	0.76	0.66	0.28	11/16	1-5/16
U8FC4	1/2	1/4	1.59	1.19	0.86	0.90	0.41	7/8	13/16
U8FC6	1/2	3/8	1.65	1.25	0.86	0.90	0.41	7/8	7/8
U8FC8	1/2	1/2	1.84	1.44	0.86	0.90	0.41	7/8	1-1/16
U8FC12	1/2	3/4	1.90	1.50	0.86	0.90	0.41	7/8	1-5/16
U10FC6	5/8	3/8	1.65	1.25	0.86	0.96	0.50	1	1-5/16
U10FC8	5/8	1/2	1.84	1.44	0.86	0.96	0.50	1	1-1/16
U12FC8	3/4	1/2	1.84	1.44	0.86	0.96	0.62	1-1/8	1-1/16
U12FC12	3/4	3/4	1.90	1.50	0.86	0.96	0.62	1-1/8	1-5/16
U14FC12	7/8	3/4	1.96	1.56	0.86	1.02	0.72	1-1/4	1-5/16
U16FC12	1	3/4	2.10	1.62	1.04	1.23	0.88	1-1/2	1-3/8
U16FC16	1	1	2.45	1.97	1.04	1.23	0.88	1-1/2	1-5/8

Finger-tight assembly dimensions (shown in inches) are for reference only and subject to change.

When ordering, specify material designator with part number (see page 3 for complete ordering information).

Tube to Female Pipe

BFC

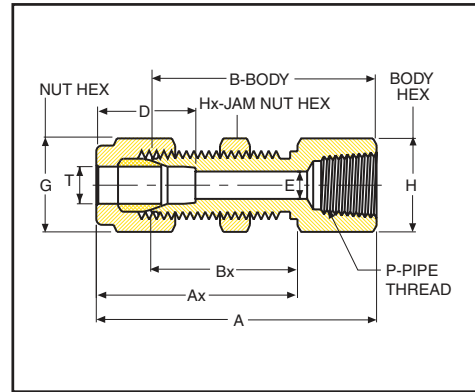
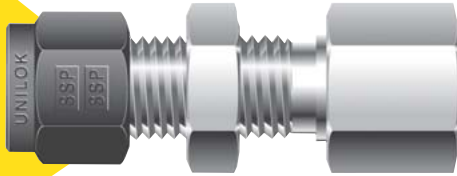

Bulkhead Female Connector

Unilok Part #	T Tube O.D.	P-NPT Female Pipe Size	A	Ax	B	Bx	D	E Minimum Opening	G	H	Hx	Maximum Panel Thickness	Panel Hole Drill Size
U2BFC2	1/8	1/8	1.76	1.23	1.50	0.97	0.50	0.09	7/16	9/16	1/2	0.50	21/64
U4BFC2	1/4	1/8	1.85	1.32	1.56	1.03	0.60	0.19	9/16	5/8	5/8	0.40	29/64
U4BFC4	1/4	1/4	2.04	1.32	1.75	1.03	0.60	0.19	9/16	3/4	5/8	0.40	29/64
U6BFC4	3/8	1/4	2.17	1.45	1.88	1.16	0.66	0.28	11/16	3/4	3/4	0.44	37/64
U8BFC6	1/2	3/8	2.43	1.65	2.03	1.25	0.90	0.41	7/8	15/16	15/16	0.50	49/64
U8BFC8	1/2	1/2	2.62	1.65	2.22	1.25	0.90	0.41	7/8	1-1/16	15/16	0.50	49/64

Unilok products are readily available from factory authorized distributors.

Finger-tight assembly dimensions (shown in inches) are for reference only and subject to change.

When ordering, specify material designator with part number (see page 3 for complete ordering information).

Tube to Female Pipe

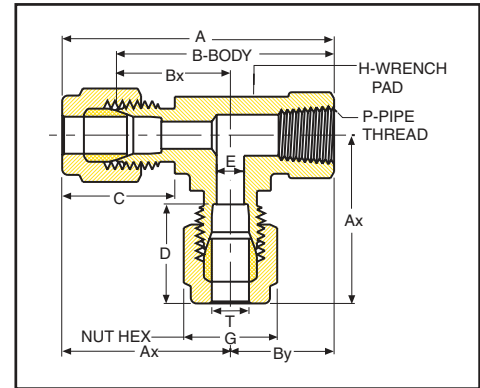
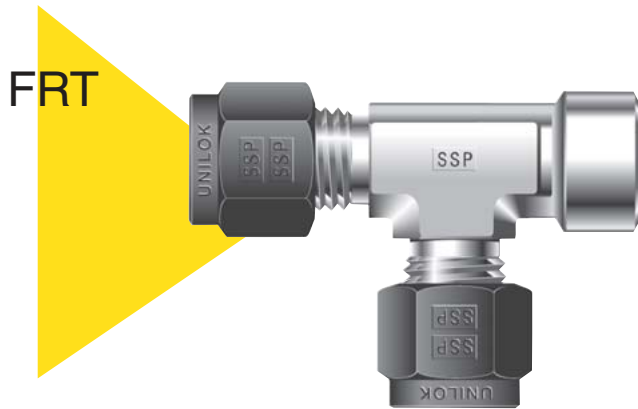

Female Run Tee

Unilok Part #	T Tube O.D.	P-NPT Female Pipe Size	A	Ax	B	Bx	By	C	D	E Minimum Opening	G	H
U2FRT2	1/8	1/8	1.72	0.97	1.46	0.71	0.75	0.60	0.50	0.09	7/16	9/16
U4FRT2	1/4	1/8	1.81	1.06	1.52	0.77	0.75	0.70	0.60	0.19	9/16	9/16
U4FRT4	1/4	1/4	2.05	1.17	1.76	0.88	0.88	0.70	0.60	0.19	9/16	3/4
U6FRT4	3/8	1/4	2.11	1.23	1.82	0.94	0.88	0.76	0.66	0.28	11/16	3/4
U8FRT6	1/2	3/8	2.30	1.42	1.90	1.02	0.88	0.86	0.90	0.41	7/8	7/8
U8FRT8	1/2	1/2	2.69	1.57	2.29	1.17	1.12	0.86	0.90	0.41	7/8	1-1/16
U12FRT12	3/4	3/4	3.01	1.76	2.61	1.36	1.25	0.86	0.96	0.62	1-1/8	1-3/8

See page 9 for the safe, simple installation instructions for Unilok tube fittings.

Tube to Female Pipe

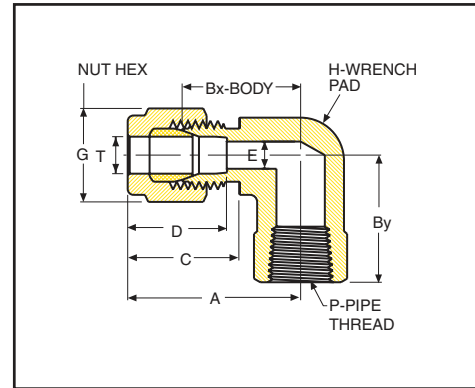
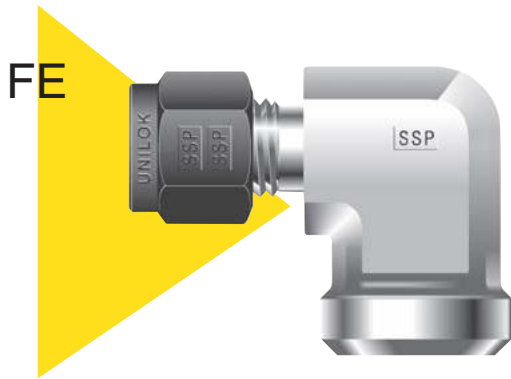

Female Elbow

Unilok Part #	T Tube O.D.	P-NPT Female Pipe Size	A	Bx	By	C	D	E Minimum Opening	G	H
U2FE2	1/8	1/8	0.97	0.71	0.75	0.60	0.50	0.09	7/16	1/2
U2FE4	1/8	1/4	1.08	0.82	0.88	0.60	0.50	0.09	7/16	11/16
U3FE2	3/16	1/8	1.00	0.74	0.75	0.63	0.54	0.12	1/2	1/2
U4FE2	1/4	1/8	1.06	0.77	0.75	0.70	0.60	0.19	9/16	1/2
U4FE4	1/4	1/4	1.17	0.88	0.88	0.70	0.60	0.19	9/16	11/16
U4FE6	1/4	3/8	1.25	0.96	0.88	0.70	0.60	0.19	9/16	7/8
U4FE8	1/4	1/2	1.36	1.07	1.12	0.70	0.60	0.19	9/16	1
U5FE2	5/16	1/8	1.13	0.84	0.75	0.73	0.64	0.25	5/8	9/16
U5FE4	5/16	1/4	1.20	0.91	0.88	0.73	0.64	0.25	5/8	11/16
U6FE2	3/8	1/8	1.20	0.91	0.75	0.76	0.66	0.28	11/16	5/8
U6FE4	3/8	1/4	1.23	0.94	0.88	0.76	0.66	0.28	11/16	11/16
U6FE6	3/8	3/8	1.31	1.02	0.88	0.76	0.66	0.28	11/16	7/8
U6FE8	3/8	1/2	1.42	1.13	1.12	0.76	0.66	0.28	11/16	1
U8FE4	1/2	1/4	1.42	1.02	0.88	0.86	0.90	0.41	7/8	13/16
U8FE6	1/2	3/8	1.42	1.02	0.88	0.86	0.90	0.41	7/8	7/8
U8FE8	1/2	1/2	1.53	1.13	1.12	0.86	0.90	0.41	7/8	1
U10FE6	5/8	3/8	1.50	1.10	0.88	0.86	0.96	0.50	1	15/16
U10FE8	5/8	1/2	1.57	1.17	1.12	0.86	0.96	0.50	1	1-1/16
U12FE8	3/4	1/2	1.57	1.17	1.12	0.86	0.96	0.62	1-1/8	1-1/16
U12FE12	3/4	3/4	1.76	1.36	1.25	0.86	0.96	0.62	1-1/8	1-3/8
U14FE12	7/8	3/4	1.76	1.36	1.25	0.86	1.02	0.72	1-1/4	1-3/8
U16FE12	1	3/4	1.93	1.45	1.25	1.04	1.23	0.88	1-1/2	1-3/8
U16FE16	1	1	2.11	1.63	1.50	1.04	1.23	0.88	1-1/2	1-5/8

Finger-tight assembly dimensions (shown in inches) are for reference only and subject to change.

When ordering, specify material designator with part number (see page 3 for complete ordering information).

Tube to Female Pipe / Tube to Tube Union

FBT

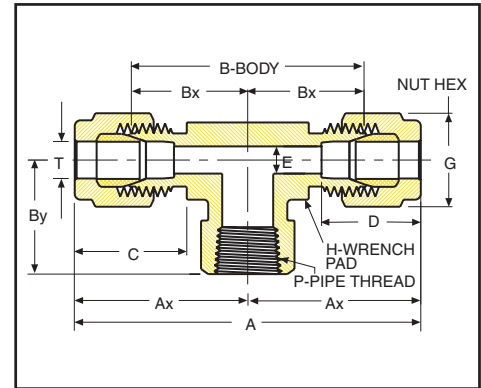
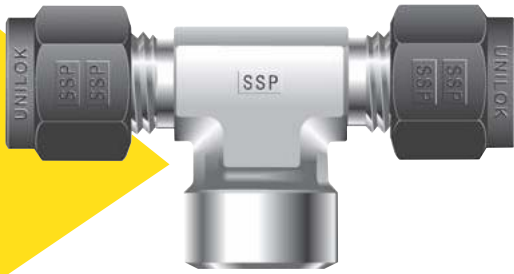

Female Branch Tee

Unilok Part #	T Tube O.D.	P-NPT Female Pipe Size	A	Ax	B	Bx	By	C	D	E Minimum Opening	G	H
U2FBT2	1/8	1/8	1.94	0.97	1.42	0.71	0.75	0.60	0.50	0.09	7/16	9/16
U4FBT2	1/4	1/8	2.12	1.06	1.54	0.77	0.75	0.70	0.60	0.19	9/16	9/16
U4FBT4	1/4	1/4	2.34	1.17	1.76	0.88	0.88	0.70	0.60	0.19	9/16	3/4
U6FBT4	3/8	1/4	2.46	1.23	1.88	0.94	0.88	0.76	0.66	0.28	11/16	3/4
U8FBT4	1/2	1/4	2.84	1.42	2.04	1.02	0.88	0.86	0.90	0.41	7/8	13/16
U8FBT6	1/2	3/8	2.84	1.42	2.04	1.02	0.88	0.86	0.90	0.41	7/8	7/8
U8FBT8	1/2	1/2	3.06	1.53	2.26	1.13	1.12	0.86	0.90	0.41	7/8	1
U10FBT8	5/8	1/2	3.06	1.53	2.26	1.13	1.12	0.86	0.96	0.50	1	1
U12FBT12	3/4	3/4	3.52	1.76	2.72	1.36	1.25	0.86	0.96	0.62	1-1/8	1-3/8
U16FBT12	1	3/4	3.86	1.93	2.90	1.45	1.25	1.04	1.23	0.88	1-1/2	1-3/8
U16FBT16	1	1	4.22	2.11	3.26	1.63	1.50	1.04	1.23	0.88	1-1/2	1-5/8

U

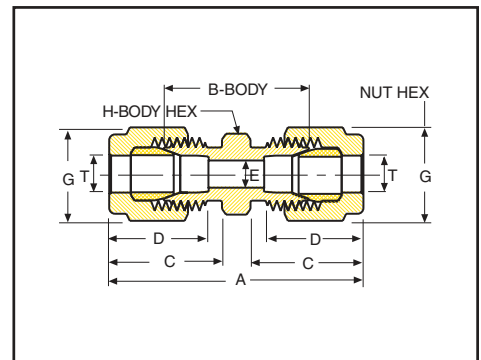

Union

Unilok Part #	T Tube O.D.	A	B	C	D	E Minimum Opening	G	H
U1U	1/16	0.99	0.69	0.43	0.34	0.05	5/16	5/16
U2U	1/8	1.40	0.88	0.60	0.50	0.09	7/16	7/16
U3U	3/16	1.47	0.95	0.63	0.54	0.12	1/2	7/16
U4U	1/4	1.61	1.03	0.70	0.60	0.19	9/16	1/2
U5U	5/16	1.69	1.11	0.73	0.64	0.25	5/8	9/16
U6U	3/8	1.77	1.19	0.76	0.66	0.28	11/16	5/8
U8U	1/2	2.02	1.22	0.86	0.90	0.41	7/8	13/16
U10U	5/8	2.05	1.25	0.86	0.96	0.50	1	15/16
U12U	3/4	2.11	1.31	0.86	0.96	0.62	1-1/8	1-1/16
U14U	7/8	2.17	1.37	0.86	1.02	0.72	1-1/4	1-3/16
U16U	1	2.55	1.59	1.04	1.23	0.88	1-1/2	1-3/8

Finger-tight assembly dimensions (shown in inches) are for reference only and subject to change.

When ordering, specify material designator with part number (see page 3 for complete ordering information).

Tube to Tube Union

BU

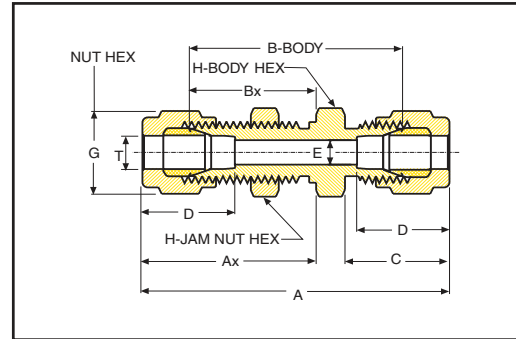

Bulkhead Union

Unilok Part #	T Tube O.D.	A	Ax	B	Bx	C	D	E Minimum Opening	G	H	Maximum Panel Thickness	Panel Hole Drill Size
U1BU	1/16	1.24	0.68	0.94	0.53	0.43	0.34	0.05	5/16	5/16	0.12	13/16
U2BU	1/8	2.02	1.23	1.50	0.97	0.60	0.50	0.09	7/16	1/2	0.50	21/64
U3BU	3/16	2.11	1.26	1.59	1.00	0.63	0.54	0.12	1/2	9/16	0.50	25/64
U4BU	1/4	2.27	1.32	1.69	1.03	0.70	0.60	0.19	9/16	5/8	0.40	29/64
U5BU	5/16	2.39	1.41	1.81	1.12	0.73	0.64	0.25	5/8	11/16	0.44	33/64
U6BU	3/8	2.45	1.45	1.87	1.16	0.76	0.66	0.28	11/16	3/4	0.44	37/64
U8BU	1/2	2.80	1.65	2.00	1.25	0.86	0.90	0.41	7/8	15/16	0.50	49/64
U10BU	5/8	2.86	1.68	2.06	1.28	0.86	0.96	0.50	1	1-1/16	0.50	57/64
U12BU	3/4	3.11	1.87	2.31	1.47	0.86	0.96	0.63	1-1/8	1-3/16	0.66	1-1/64
U16BU	1	3.77	2.26	2.81	1.78	1.04	1.23	0.88	1-1/2	1-5/8	0.75	1-21/64

BRU

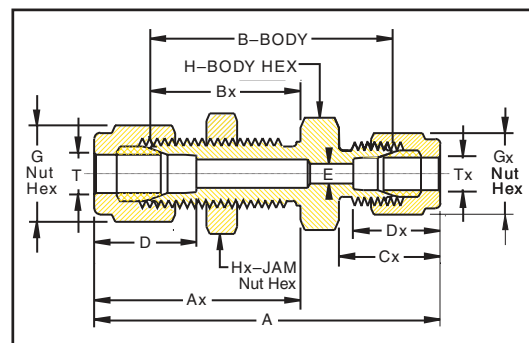
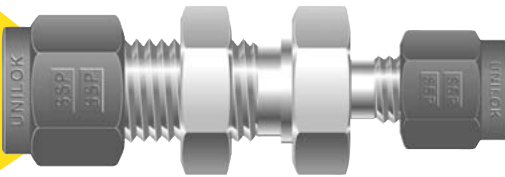

Bulkhead Reducing Union

Unilok Part #	T Tube O.D.	Tx Tube O.D.	A	Ax	B	Bx	Cx	D	Dx	E Minimum Opening	G	Gx	H	Hx	Maximum Panel Thickness	Panel Hole Drill Size
U4BRU2	1/4	1/8	2.17	1.32	1.62	1.03	.60	.60	.50	.09	9/16	7/16	5/8	5/8	.40	29/64
U6BRU4	3/8	1/4	2.39	1.44	1.81	1.16	.70	.66	.60	.19	11/16	9/16	3/4	3/4	.44	37/64
U8BRU4	1/2	1/4	2.63	1.65	1.94	1.25	.70	.90	.60	.19	7/8	9/16	15/16	15/16	.50	49/64
U8BRU6	1/2	3/8	2.68	1.65	1.99	1.25	.75	.90	.66	.19	7/8	11/16	15/16	15/16	.50	49/64

Finger-tight assembly dimensions (shown in inches) are for reference only and subject to change.

When ordering, specify material designator with part number (see page 3 for complete ordering information).

Tube to Tube Union

RU

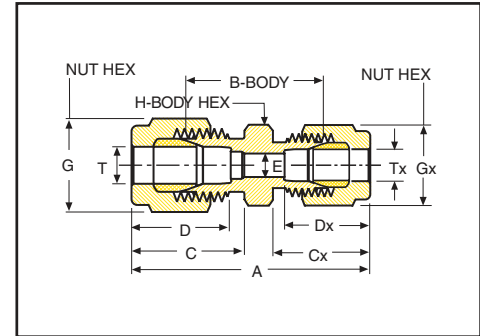
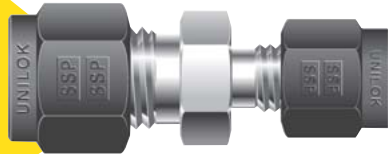

Reducing Union

Unilok Part #	T Tube O.D.	Tx Tube O.D.	A	B	C	Cx	D	Dx	E Minimum Opening	G	Gx	H
U2RU1	1/8	1/16	1.22	0.81	0.60	0.43	0.50	0.34	0.05	7/16	5/16	7/16
U3RU1	3/16	1/16	1.27	0.86	0.63	0.43	0.54	0.34	0.05	1/2	5/16	7/16
U3RU2	3/16	1/8	1.44	0.92	0.63	0.60	0.54	0.50	0.09	1/2	7/16	7/16
U4RU1	1/4	1/16	1.35	0.91	0.70	0.43	0.60	0.34	0.05	9/16	5/16	1/2
U4RU2	1/4	1/8	1.52	0.97	0.70	0.60	0.60	0.50	0.09	9/16	7/16	1/2
U4RU3	1/4	3/16	1.55	1.00	0.70	0.63	0.60	0.54	0.12	9/16	1/2	1/2
U5RU2	5/16	1/8	1.57	1.02	0.73	0.60	0.64	0.50	0.09	5/8	7/16	9/16
U5RU4	5/16	1/4	1.66	1.08	0.73	0.70	0.64	0.60	0.19	5/8	9/16	9/16
U6RU1	3/8	1/16	1.44	1.00	0.76	0.43	0.66	0.34	0.05	11/16	5/16	5/8
U6RU2	3/8	1/8	1.61	1.06	0.76	0.60	0.66	0.50	0.09	11/16	7/16	5/8
U6RU4	3/8	1/4	1.70	1.12	0.76	0.70	0.66	0.60	0.19	11/16	9/16	5/8
U6RU5	3/8	5/16	1.74	1.16	0.76	0.73	0.66	0.64	0.25	11/16	5/8	5/8
U8RU2	1/2	1/8	1.78	1.12	0.86	0.60	0.90	0.50	0.09	7/8	7/16	13/16
U8RU4	1/2	1/4	1.85	1.16	0.86	0.70	0.90	0.60	0.19	7/8	9/16	13/16
U8RU6	1/2	3/8	1.91	1.22	0.86	0.76	0.90	0.66	0.28	7/8	11/16	13/16
U10RU6	5/8	3/8	1.94	1.25	0.86	0.76	0.96	0.66	0.28	1	11/16	15/16
U10RU8	5/8	1/2	2.05	1.25	0.86	0.86	0.96	0.90	0.41	1	7/8	15/16
U12RU4	3/4	1/4	1.94	1.25	0.86	0.70	0.96	0.60	0.19	1-1/8	9/16	1-1/16
U12RU6	3/4	3/8	2.00	1.31	0.86	0.76	0.96	0.66	0.28	1-1/8	11/16	1-1/16
U12RU8	3/4	1/2	2.11	1.31	0.86	0.86	0.96	0.90	0.41	1-1/8	7/8	1-1/16
U12RU10	3/4	5/8	2.11	1.31	0.86	0.86	0.96	0.96	0.50	1-1/8	1	1-1/16
U16RU8	1	1/2	2.49	1.61	1.04	0.86	1.23	0.90	0.41	1-1/2	7/8	1-3/8
U16RU12	1	3/4	2.47	1.59	1.04	0.86	1.23	0.96	0.62	1-1/2	1-1/8	1-3/8

Safety and installation seminars are available through the factory authorized Unilok tube fittings distributor.

Tube to Tube Union

UE

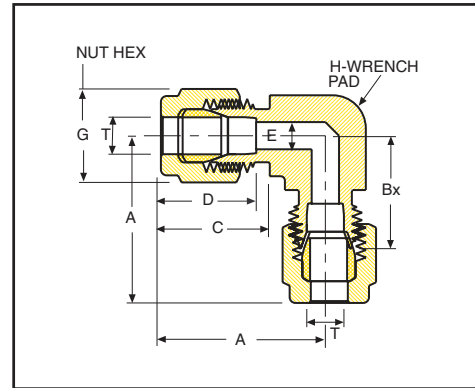
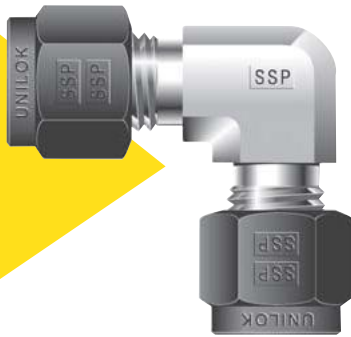

Union Elbow

Unilok Part #	T Tube O.D.	A	Bx	C	D	E Minimum Opening	G	H
U1UE	1/16	0.70	0.55	0.43	0.34	0.05	5/16	3/8
U2UE	1/8	0.88	0.62	0.60	0.50	0.09	7/16	3/8
U3UE	3/16	1.00	0.74	0.63	0.54	0.12	1/2	1/2
U4UE	1/4	1.06	0.77	0.70	0.60	0.19	9/16	1/2
U5UE	5/16	1.13	0.84	0.73	0.64	0.25	5/8	9/16
U6UE	3/8	1.20	0.91	0.76	0.66	0.28	11/16	5/8
U8UE	1/2	1.42	1.02	0.86	0.90	0.41	7/8	13/16
U10UE	5/8	1.50	1.10	0.86	0.96	0.50	1	15/16
U12UE	3/4	1.57	1.17	0.86	0.96	0.62	1-1/8	1-1/16
U14UE	7/8	1.76	1.36	0.86	1.02	0.72	1-1/4	1-3/8
U16UE	1	1.93	1.45	1.04	1.23	0.88	1-1/2	1-3/8

UCS

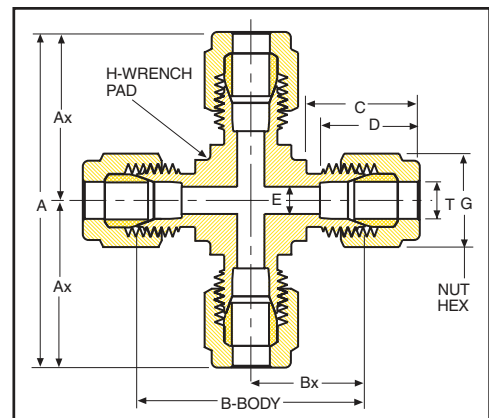
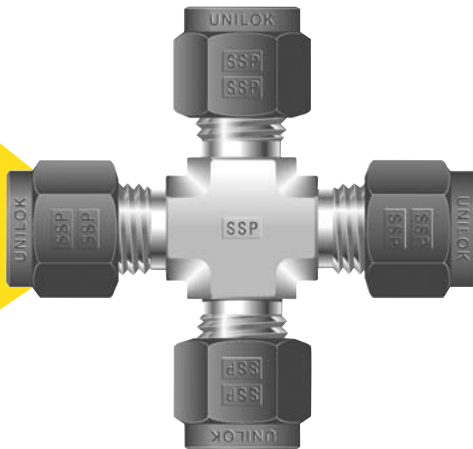

Union Cross

Unilok Part #	T Tube O.D.	A	Ax	B	Bx	C	D	E Minimum Opening	G	H
U2UCS	1/8	1.76	0.88	1.24	0.62	0.60	0.50	0.09	7/16	3/8
U4UCS	1/4	2.12	1.06	1.54	0.77	0.70	0.60	0.19	9/16	1/2
U5UCS	5/16	2.34	1.17	1.76	0.88	0.73	0.64	0.25	5/8	5/8
U6UCS	3/8	2.40	1.20	1.82	0.91	0.76	0.66	0.28	11/16	5/8
U8UCS	1/2	2.84	1.42	2.04	1.02	0.86	0.90	0.41	7/8	13/16
U12UCS	3/4	3.14	1.57	2.34	1.17	0.86	0.96	0.62	1-1/8	1-1/16
U16UCS	1	3.86	1.93	2.90	1.45	1.04	1.23	0.88	1-1/2	1-5/16

Finger-tight assembly dimensions (shown in inches) are for reference only and subject to change.

When ordering, specify material designator with part number (see page 3 for complete ordering information).

Tube to Tube Union

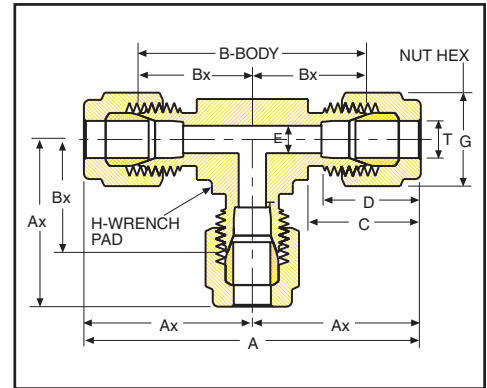
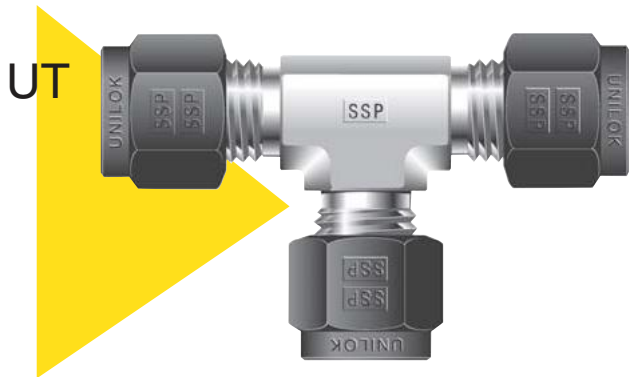

Union Tee

Unilok Part #	T Tube O.D.	A	Ax	B	Bx	C	D	E Minimum Opening	G	H
U1UT	1/16	1.40	0.70	1.10	0.55	0.43	0.34	0.05	5/16	3/8
U2UT	1/8	1.76	0.88	1.24	0.62	0.60	0.50	0.09	7/16	3/8
U3UT	3/16	1.92	0.96	1.40	0.70	0.63	0.54	0.12	1/2	7/16
U4UT	1/4	2.12	1.06	1.54	0.77	0.70	0.60	0.19	9/16	1/2
U5UT	5/16	2.34	1.17	1.76	0.88	0.73	0.64	0.25	5/8	5/8
U6UT	3/8	2.40	1.20	1.82	0.91	0.76	0.66	0.28	11/16	5/8
U8UT	1/2	2.84	1.42	2.04	1.02	0.86	0.90	0.41	7/8	13/16
U10UT	5/8	3.06	1.53	2.26	1.13	0.86	0.96	0.50	1	1
U12UT	3/4	3.14	1.57	2.34	1.17	0.86	0.96	0.62	1-1/8	1/16
U14UT	7/8	3.52	1.76	2.72	1.36	0.86	1.02	0.72	1-1/4	1-3/8
U16UT	1	3.86	1.93	2.90	1.45	1.04	1.23	0.88	1-1/2	1-3/8

Heat Exchanger Tee

Custom configuration, forged heat exchanger tees can be designed and manufactured by SSP to customers' specific design criteria. Additionally, heat exchanger tees may be assembled by utilizing standard union tees (UT) combined with reducers that have been "bored through" (RBT fittings) to allow the process tube to be inserted into and through the jacketing tube.

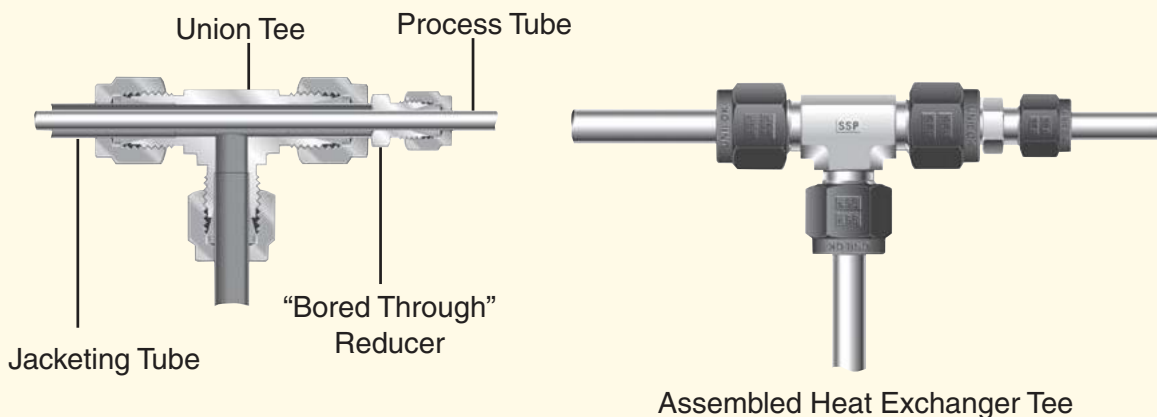

Note: Pressure ratings of "bored through" fittings are reduced.
For additional information on a specific fitting's rating, contact your local distributor.

Tube to Tube Union

RUT

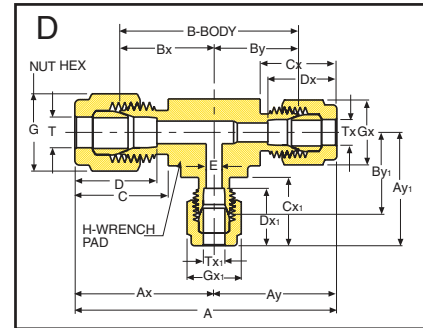
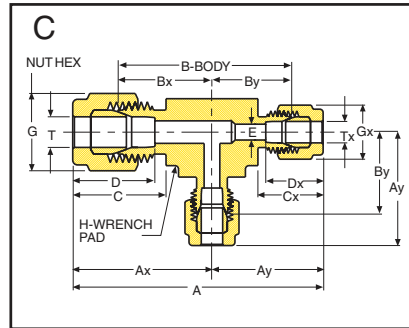
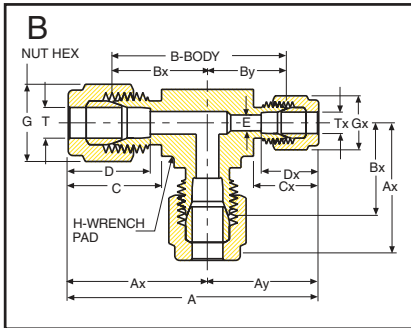
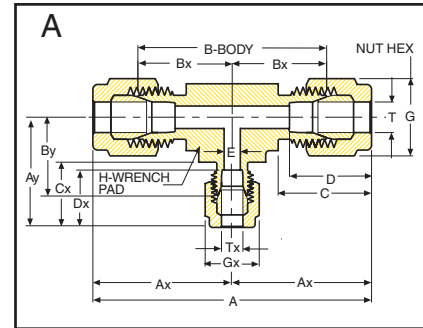

Reducing Union Tee - Configuration A

Unilok Part #	T Tube O.D.	Tx Tube O.D.	A	Ax	Ay	B	Bx	By	C	Cx	D	Dx	E	G	Gx	H
U6RUT64	3/8	1/4	2.40	1.20	1.14	1.82	.91	0.85	0.76	0.70	0.66	0.60	0.19	11/16	9/16	5/8
U8RUT84	1/2	1/4	2.84	1.42	1.25	2.04	1.02	0.96	0.86	0.70	0.90	0.60	0.19	7/8	9/16	13/16
U8RUT86	1/2	3/8	2.84	1.42	1.31	2.04	1.02	1.02	0.86	0.76	0.90	0.66	0.28	7/8	11/16	13/16
U10RUT106	5/8	3/8	3.06	1.53	1.42	2.26	1.13	1.13	0.86	0.76	0.96	0.66	0.28	1	11/16	1
U12RUT126	3/4	3/8	3.14	1.57	1.46	2.34	1.17	1.17	0.86	0.76	0.96	0.66	0.28	1-1/8	11/16	1-1/16
U12RUT128	3/4	1/2	3.14	1.57	1.57	2.34	1.17	1.17	0.86	0.86	0.96	0.90	0.41	1-1/8	7/8	1-1/16
U16RUT166	1	3/8	3.86	1.93	1.65	2.90	1.45	1.36	1.04	0.76	1.23	0.66	0.28	1-1/2	1-1/16	1-3/8
U16RUT168	1	1/2	3.86	1.93	1.76	2.90	1.45	1.36	1.04	0.90	1.23	0.86	0.41	1-1/2	7/8	1-3/8
U16RUT1612	1	3/4	3.86	1.93	1.76	2.90	1.45	1.36	1.04	0.86	1.23	0.96	0.62	1-1/2	1-1/8	1-3/8

Reducing Union Tee - Configuration B

Unilok Part #	T Tube O.D.	Tx Tube O.D.	A	Ax	Ay	B	Bx	By	C	Cx	D	Dx	E	G	Gx	H
U6RUT46	3/8	1/4	2.34	1.20	1.14	1.76	0.91	0.85	0.76	0.70	0.66	0.60	0.19	11/16	9/16	5/8

Reducing Union Tee - Configuration C

Unilok Part #	T Tube O.D.	Tx Tube O.D.	A	Ax	Ay	B	Bx	By	C	Cx	D	Dx	E	G	Gx	H
U8RUT66	1/2	3/8	2.73	1.42	1.31	2.04	1.02	1.02	0.86	0.76	0.90	0.66	0.28	7/8	11/16	13/16
U10RUT66	5/8	3/8	2.95	1.53	1.42	2.26	1.13	1.13	0.86	0.76	0.96	0.66	0.28	1	11/16	1
U12RUT66	3/4	3/8	3.03	1.57	1.46	2.34	1.17	1.17	0.86	0.76	0.96	0.66	0.28	1-1/8	11/16	1-1/16

Reducing Union Tee - Configuration D

Unilok Part #	T Tube O.D.	Tx Tube O.D.	Tx1 Tube O.D.	A	Ax	Ay	Ay1	B	Bx	By	By1	C	Cx	Cx1	D	Dx	Dx1	E	G	Gx	Gx1	H
U10RUT86	5/8	1/2	3/8	3.06	1.53	1.53	1.42	2.26	1.13	1.13	1.13	0.86	0.86	0.76	0.96	0.90	0.66	0.28	1	7/8	11/16	1
U12RUT86	3/4	1/2	3/8	3.14	1.57	1.57	1.46	2.34	1.17	1.17	1.17	0.86	0.86	0.76	0.96	0.90	0.66	0.28	1-1/16	7/8	11/16	1-1/16
U16RUT126	1	3/4	3/8	3.69	1.93	1.76	1.66	2.81	1.45	1.36	1.36	1.04	0.86	0.76	1.33	0.96	0.66	0.28	1-3/8	1-1/8	11/16	1-3/8

Finger-tight assembly dimensions (shown in inches) are for reference only and subject to change.

When ordering, specify material designator with part number (see page 3 for complete ordering information).

Tube to Tube Union

DA

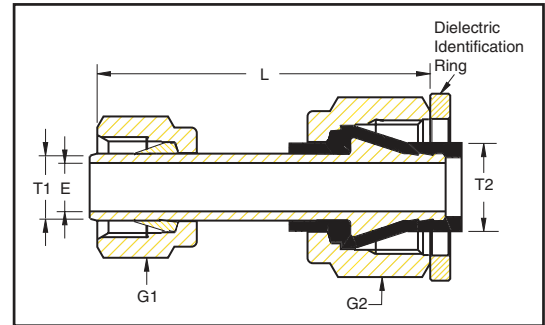
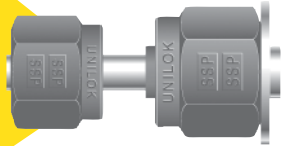

Dielectric Adapter

The SSP Instrumentation Dielectric Adapter is supplied with pre-swaged 3/8" nut and ferrules. The dielectric connection has a captive 1/2" nut. Dielectric Stop Collar and assembly instructions are also supplied with the adapter. By using 3/8" and 1/2" tube-ended SSP Instrumentation tube fittings with the adapter, a wide range of dielectric fitting configurations can be built.

Unilok Part #	T1 Tube End	T2 Tube End	L	E	G1 Hex	G2 Hex
U8DA6	3/8	1/2	2.08	0.30	11/16	7/8

DU

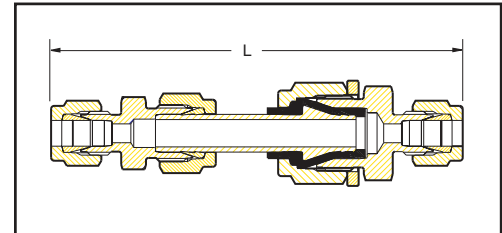

Dielectric Union

Dielectric fittings are designed to isolate monitoring and control instruments and equipment from electrical current and voltages. Manufactured in 316 stainless steel with thermoplastic insulators, SSP Instrumentation's dielectric fittings provide high dielectric strength in applications up to 5,000 PSIG. Typical applications for dielectric fittings are on impulse lines in natural gas pipeline monitoring stations. For additional factory assembled configurations, contact your local distributor.

Unilok Part #	L (inches)
U4DU	4.08
U6DU	4.20
U8DU	4.79
U6DMC4	3.80

Materials and Technical Data

Body: 316 Stainless Steel

Insulator: Polyamide-imide

Pressure Rating: 5,000 PSIG

Temperature Rating: From -40°F to +200°F

Electrical Resistance: 1.0 x 10E7 Ohm at 70°F (20°C) at 10 VDC @ 50% relative humidity; voltage breakdown resistance of 3,000 VDC.

Finger-tight assembly dimensions (shown in inches) are for reference only and subject to change.

When ordering, specify material designator with part number (see page 3 for complete ordering information).

Tube to Welded Systems

TSWU

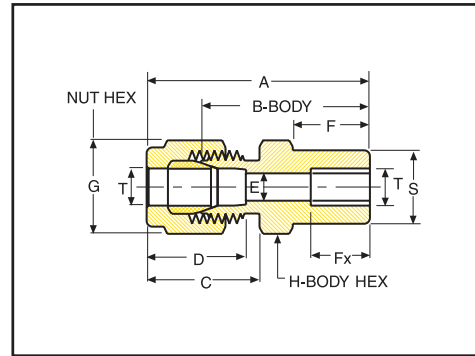

Tube Socket Weld Union

Unilok Part #	T Tube O.D.	A	B	C	D	E Minimum Opening	F	Fx	G	H	S
U2TSWU2	1/8	1.14	0.88	0.60	0.50	0.09	0.34	0.25	7/16	7/16	0.31
U4TSWU4	1/4	1.32	1.03	0.70	0.60	0.19	0.41	0.31	9/16	1/2	0.44
U6TSWU6	3/8	1.48	1.19	0.76	0.66	0.28	0.47	0.38	11/16	5/8	0.62
U8TSWU8	1/2	1.62	1.22	0.86	0.90	0.41	0.47	0.50	7/8	13/16	0.75
U12TSWU12	3/4	1.71	1.31	0.86	0.96	0.62	0.47	0.56	1-1/8	1-1/16	1.05
U16TSWU16	1	2.07	1.59	1.04	1.23	0.88	0.56	0.75	1-1/2	1-3/8	1.31

TSWE

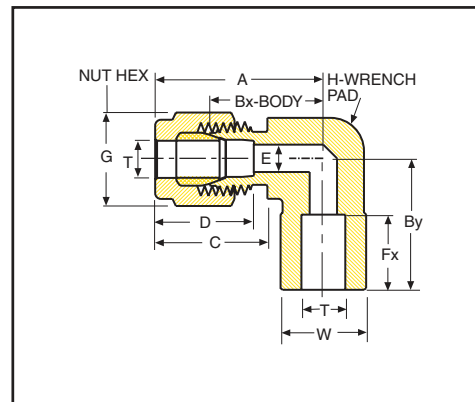

Tube Socket Weld Elbow

Unilok Part #	T Tube O.D.	A	Bx	By	C	D	E Minimum Opening	Fx	G	H	W
U4TSWE4	1/4	1.06	0.77	0.77	0.70	0.60	0.19	0.31	9/16	1/2	0.500
U6TSWE6	3/8	1.20	0.91	0.91	0.76	0.66	0.28	0.38	11/16	11/16	0.620
U8TSWE8	1/2	1.42	1.02	1.02	0.86	0.90	0.41	0.50	7/8	7/8	0.810

Unilok tube fittings with weld ends allow weld system connection to tubing with the advantage of a leak tight seal that can be disassembled in an otherwise permanently welded system. Weld ends conform to ANSI B31.1 and B31.3 piping codes. **Welding precautions:** Prior to welding, remove the nut and ferrule. To protect the fitting body threads and seat, cover with a plug or another nut. Position a suitable heat sink to dissipate the heat. Insert the tube until bottomed in the socket, then back out approximately 1/16" before welding.

Note: The welding of a bottomed tube may lead to stress-cracking of the weld. To hold the fitting in proper alignment, tack weld the fitting in four places (90° apart) and then complete the weld. After welding, remove the protective plug or nut and replace with the nut and ferrule for tube installation following the instructions from page 9.

Finger-tight assembly dimensions (shown in inches) are for reference only and subject to change.

When ordering, specify material designator with part number (see page 3 for complete ordering information).

Tube to Welded Systems

MPWC

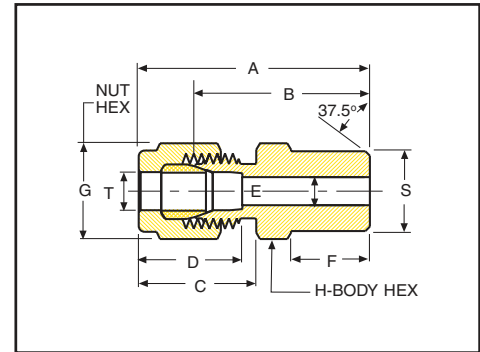

Male Pipe Weld Connector

Unilok Part #	T Tube O.D.	Male Pipe Weld Size	A	B	C	D	E Minimum Opening	F	G	H	S
U2MPWC2	1/8	1/8	1.20	0.94	0.60	0.50	0.09	0.38	7/16	7/16	0.405
U3MPWC2	3/16	1/8	1.23	0.97	0.63	0.54	0.12	0.38	1/2	7/16	0.405
U4MPWC2	1/4	1/8	1.29	1.00	0.70	0.60	0.19	0.38	9/16	1/2	0.405
U4MPWC4	1/4	1/4	1.49	1.20	0.70	0.60	0.19	0.56	9/16	9/16	0.540
U5MPWC2	5/16	1/8	1.34	1.05	0.73	0.64	0.20	0.38	5/8	9/16	0.405
U5MPWC4	5/16	1/4	1.52	1.23	0.73	0.64	0.25	0.56	5/8	9/16	0.540
U6MPWC4	3/8	1/4	1.57	1.28	0.76	0.66	0.28	0.56	11/16	5/8	0.540
U6MPWC6	3/8	3/8	1.57	1.28	0.76	0.66	0.28	0.56	11/16	11/16	0.675
U6MPWC8	3/8	1/2	1.82	1.53	0.76	0.66	0.28	0.75	11/16	7/8	0.840
U8MPWC6	1/2	3/8	1.71	1.31	0.86	0.90	0.41	0.56	7/8	13/16	0.675
U8MPWC8	1/2	1/2	1.93	1.53	0.86	0.90	0.41	0.75	7/8	7/8	0.840
U8MPWC12	1/2	3/4	1.99	1.59	0.86	0.90	0.41	0.75	7/8	1-1/16	1.050
U10MPWC8	5/8	1/2	1.93	1.53	0.86	0.96	0.50	0.75	1	15/16	0.840
U12MPWC12	3/4	3/4	1.99	1.59	0.86	0.96	0.62	0.75	1-1/8	1-1/16	1.050
U16MPWC16	1	1	2.45	1.97	1.04	1.23	0.86	0.94	1-1/2	1-3/8	1.315

MPWE

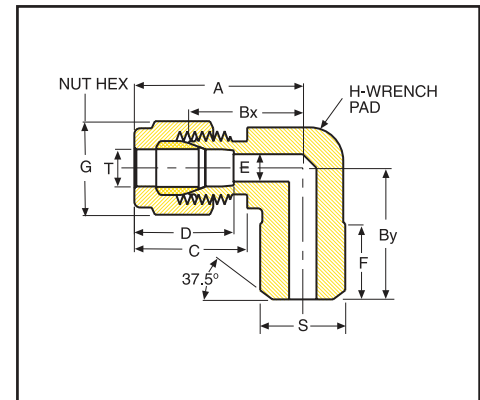

Male Pipe Weld Elbow

Unilok Part #	T Tube O.D.	Male Pipe Weld Size	A	Bx	By	C	D	E Minimum Opening	F	G	H	S
U4MPWE2	1/4	1/8	1.06	0.77	0.74	0.70	0.60	0.19	0.38	9/16	1/2	0.405
U4MPWE4	1/4	1/4	1.06	0.77	0.92	0.70	0.60	0.19	0.56	9/16	1/2	0.540
U6MPWE4	3/8	1/4	1.20	0.91	1.00	0.76	0.66	0.28	0.56	11/16	5/8	0.540
U8MPWE8	1/2	1/2	1.42	1.02	1.30	0.86	0.90	0.41	0.75	7/8	7/8	0.840
U12MPWE12	3/4	3/4	1.57	1.17	1.45	0.86	0.96	0.62	0.75	1-1/8	1-1/16	1.050

Finger-tight assembly dimensions (shown in inches) are for reference only and subject to change.

When ordering, specify material designator with part number (see page 3 for complete ordering information).

Tube Stub Connectors / Adapters

BR

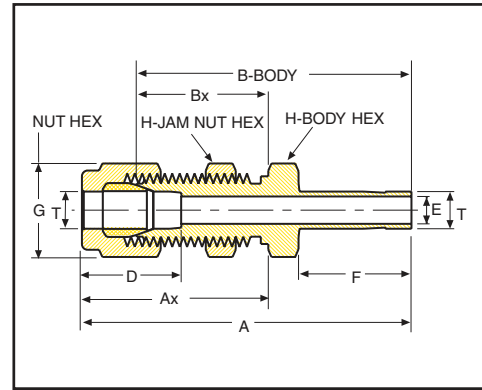
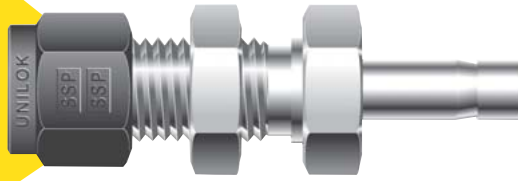

Bulkhead Reducer/Adapter

Unilok Part #	T Tube O.D.	A	Ax	B	Bx	D	E Minimum Opening	F	G	H	Maximum Panel Thickness	Panel Hole Drill Size
U2BR2	1/8	1.95	1.23	1.69	0.97	0.50	0.06	0.53	7/16	1/2	0.50	21/64
U4BR4	1/4	2.20	1.32	1.91	1.03	0.60	0.11	0.62	9/16	5/8	0.40	29/64
U6BR6	3/8	2.41	1.45	2.12	1.16	0.66	0.24	0.69	11/16	3/4	0.44	37/64
U8BR8	1/2	2.87	1.65	2.47	1.25	0.90	0.33	0.91	7/8	15/16	0.50	49/64

The Bulkhead Reducer/Adapter tube fitting provides the greatest connection flexibility in panel installations. The Bulkhead Reducer/Adapter can be used with any proper size Unilok tube fitting configuration to meet the installer's special requirements.

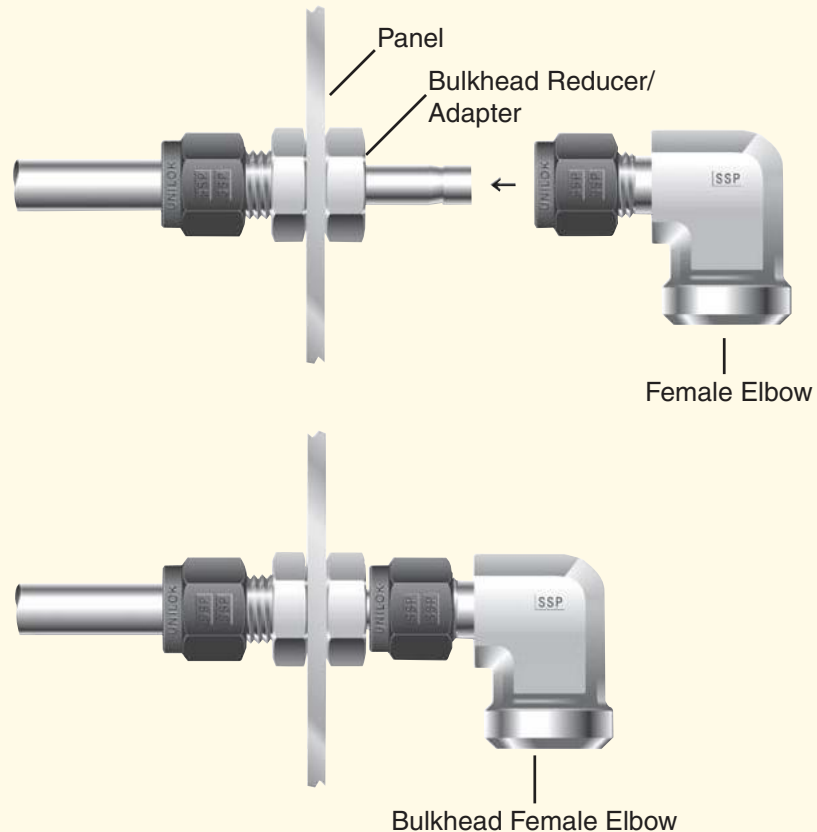

Finger-tight assembly dimensions (shown in inches) are for reference only and subject to change.

When ordering, specify material designator with part number (see page 3 for complete ordering information).

Tube Stub Connectors / Adapters

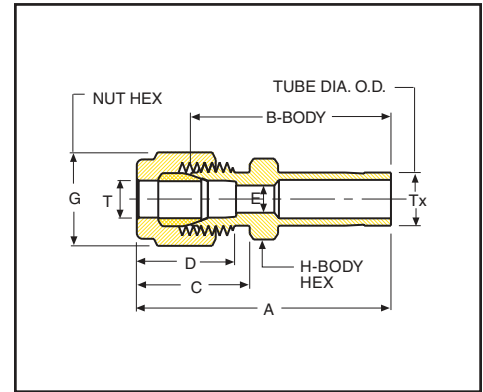
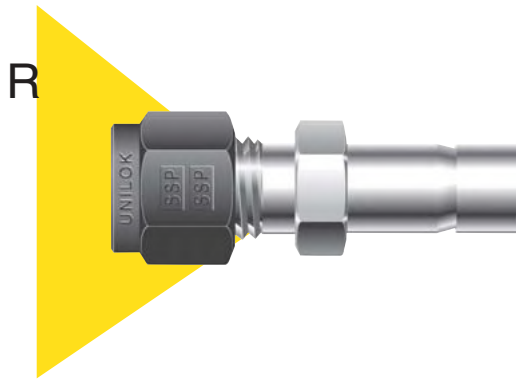

Reducer/Adapter*

Unilok Part #	T Tube O.D.	Tx O.D.	A	B	C	D	E Minimum Opening	G	H
U1R2	1/16	1/8	1.15	1.00	0.43	0.34	0.06	5/16	5/16
U1R4	1/16	1/4	1.24	1.09	0.43	0.34	0.11	5/16	5/16
U2R1	1/8	1/16	1.14	0.88	0.60	0.50	0.02	7/16	7/16
U2R2	1/8	1/8	1.32	1.06	0.60	0.50	0.06	7/16	7/16
U2R3	1/8	3/16	1.35	1.09	0.60	0.50	0.08	7/16	7/16
U2R4	1/8	1/4	1.42	1.16	0.60	0.50	0.11	7/16	7/16
U2R6	1/8	3/8	1.48	1.22	0.60	0.50	0.24	7/16	7/16
U2R8	1/8	1/2	1.74	1.48	0.60	0.50	0.33	7/16	9/16
U3R2	3/16	1/8	1.37	1.11	0.63	0.54	0.06	1/2	7/16
U3R4	3/16	1/4	1.46	1.20	0.63	0.54	0.11	1/2	7/16
U4R2	1/4	1/8	1.45	1.16	0.70	0.60	0.06	9/16	1/2
U4R3	1/4	3/16	1.48	1.19	0.70	0.60	0.08	9/16	1/2
U4R4	1/4	1/4	1.54	1.25	0.70	0.60	0.11	9/16	1/2
U4R5	1/4	5/16	1.57	1.28	0.70	0.60	0.18	9/16	1/2
U4R6	1/4	3/8	1.60	1.31	0.70	0.60	0.24	9/16	1/2
U4R8	1/4	1/2	1.82	1.53	0.70	0.60	0.33	9/16	9/16
U4R10	1/4	5/8	1.89	1.60	0.70	0.60	0.42	9/16	11/16
U4R12	1/4	3/4	1.88	1.59	0.70	0.60	0.51	9/16	13/16
U5R6	5/16	3/8	1.65	1.36	0.73	0.64	0.24	5/8	9/16
U5R8	5/16	1/2	1.87	1.58	0.73	0.64	0.33	5/8	9/16
U6R4	3/8	1/4	1.63	1.34	0.76	0.66	0.15	11/16	5/8
U6R6	3/8	3/8	1.70	1.41	0.76	0.66	0.24	11/16	5/8
U6R8	3/8	1/2	1.91	1.62	0.76	0.66	0.33	11/16	5/8
U6R10	3/8	5/8	1.98	1.69	0.76	0.66	0.42	11/16	11/16
U6R12	3/8	3/4	1.98	1.69	0.76	0.66	0.51	11/16	13/16
U8R4	1/2	1/4	1.77	1.37	0.86	0.90	0.15	7/8	13/16
U8R6	1/2	3/8	1.84	1.44	0.86	0.90	0.24	7/8	13/16
U8R8	1/2	1/2	2.06	1.66	0.86	0.90	0.33	7/8	13/16
U8R10	1/2	5/8	2.12	1.72	0.86	0.90	0.42	7/8	13/16
U8R12	1/2	3/4	2.12	1.72	0.86	0.90	0.51	7/8	13/16
U8R16	1/2	1	2.37	1.97	0.86	0.90	0.75	7/8	1-1/16
U10R12	5/8	3/4	2.15	1.75	0.86	0.96	0.51	1	15/16
U10R14	5/8	7/8	2.21	1.81	0.86	0.96	0.64	1	15/16
U10R16	5/8	1	2.40	2.00	0.86	0.96	0.75	1	1-1/16
U12R8	3/4	1/2	2.15	1.75	0.86	0.96	0.34	1-1/8	1-1/16
U12R16	3/4	1	2.46	2.06	0.86	0.96	0.75	1-1/8	1-1/16

* Note: For Heat Exchanger Tee applications (see page 27), certain Reducer/Adapter fittings can be "bored through" to accommodate a process tube's insertion. Consult with the local distributor for further information on "bored through" Reducer/Adapter (RBT) fittings.

Finger-tight assembly dimensions (shown in inches) are for reference only and subject to change.

When ordering, specify material designator with part number (see page 3 for complete ordering information).

Tube Stub Connectors / Adapters

MA

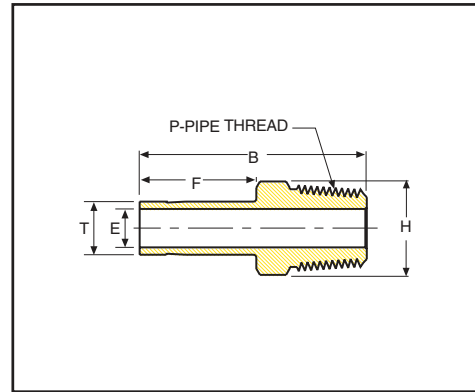
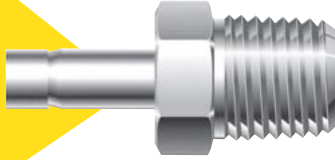

Male Adapter

Unilok Part #	T Tube O.D.	P-NPT Male Pipe Size	B	E Minimum Opening	F Min.	H
U2MA2	1/8	1/8	1.12	0.04	0.38	7/16
U2MA4	1/8	1/4	1.31	0.05	0.56	9/16
U3MA2	3/16	1/8	1.15	0.08	0.38	7/16
U3MA4	3/16	1/4	1.34	0.10	0.56	9/16
U4MA2	1/4	1/8	1.21	0.12	0.38	7/16
U4MA4	1/4	1/4	1.40	0.13	0.56	9/16
U4MA6	1/4	3/8	1.43	0.14	0.56	11/16
U4MA8	1/4	1/2	1.65	0.14	0.75	7/8
U5MA2	5/16	1/8	1.25	0.18	0.38	7/16
U5MA4	5/16	1/4	1.46	0.18	0.56	9/16
U6MA2	3/8	1/8	1.31	0.19	0.38	7/16
U6MA4	3/8	1/4	1.50	0.24	0.56	9/16
U6MA6	3/8	3/8	1.50	0.24	0.56	11/16
U6MA8	3/8	1/2	1.71	0.24	0.75	7/8
U8MA4	1/2	1/4	1.71	0.28	0.56	9/16
U8MA6	1/2	3/8	1.75	0.33	0.56	11/16
U8MA8	1/2	1/2	1.93	0.33	0.75	7/8
U10MA8	5/8	1/2	2.00	0.42	0.75	7/8
U12MA8	3/4	1/2	2.00	0.47	0.75	7/8
U12MA12	3/4	3/4	2.03	0.51	0.75	1-1/16
U16MA12	1	3/4	2.28	0.62	0.75	1-1/16
U16MA16	1	1	2.56	0.75	0.94	1-3/8

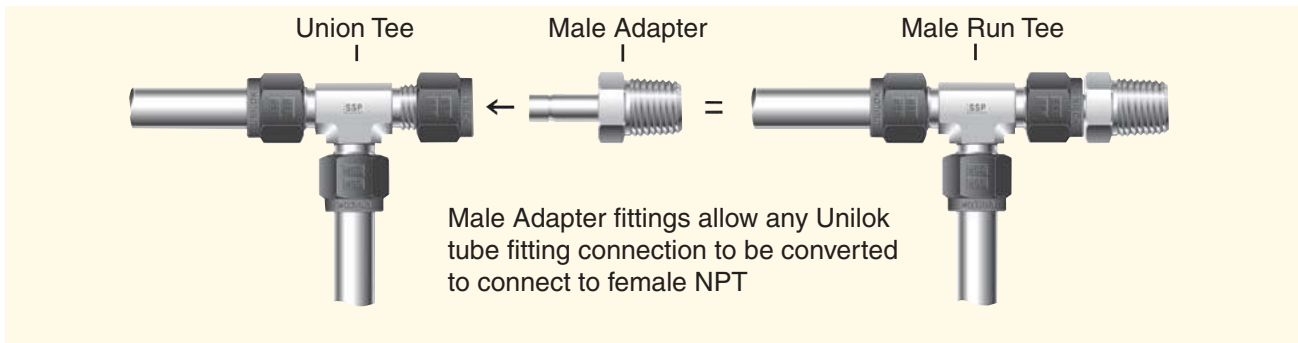

Finger-tight assembly dimensions (shown in inches) are for reference only and subject to change.

When ordering, specify material designator with part number (see page 3 for complete ordering information).

Tube Stub Connectors / Adapters

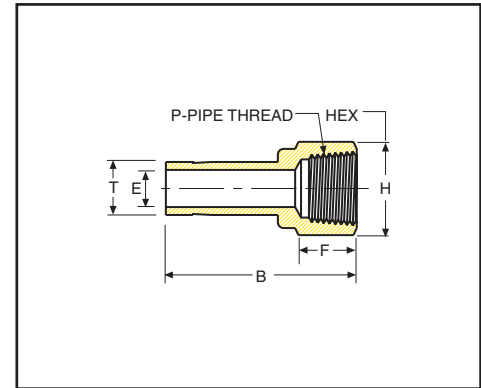
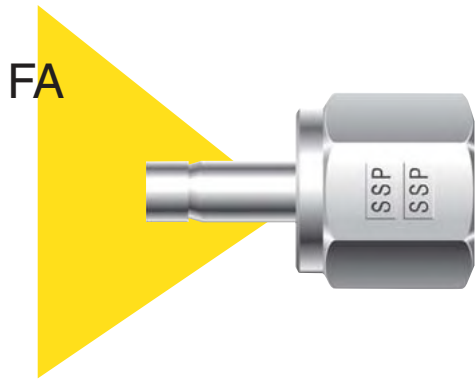

Female Adapter

Unilok Part #	T Tube O.D.	P-NPT Female Pipe Size	B	E Minimum Opening	H
U2FA2	1/8	1/8	1.23	0.07	9/16
U2FA4	1/8	1/4	1.34	0.07	3/4
U3FA4	3/16	1/4	1.37	0.12	3/4
U4FA2	1/4	1/8	1.32	0.18	9/16
U4FA4	1/4	1/4	1.43	0.18	3/4
U4FA6	1/4	3/8	1.56	0.18	7/8
U4FA8	1/4	1/2	1.46	0.18	1-1/16
U5FA4	5/16	1/4	1.46	0.25	3/4
U6FA2	3/8	1/8	1.39	0.28	9/16
U6FA4	3/8	1/4	1.50	0.28	3/4
U6FA6	3/8	3/8	1.62	0.28	7/8
U6FA8	3/8	1/2	1.84	0.28	1-1/16
U8FA4	1/2	1/4	1.71	0.39	3/4
U8FA6	1/2	3/8	1.84	0.39	7/8
U8FA8	1/2	1/2	2.06	0.39	1-1/16
U10FA8	5/8	1/2	2.12	0.50	1-1/16
U12FA8	3/4	1/2	2.12	0.59	1-1/16
U12FA12	3/4	3/4	2.18	0.59	1-5/16
U12FA16	3/4	1	2.46	0.59	1-5/8
U16FA12	1	3/4	2.43	0.95	1-1/4
U16FA16	1	1	2.71	0.95	1-5/8

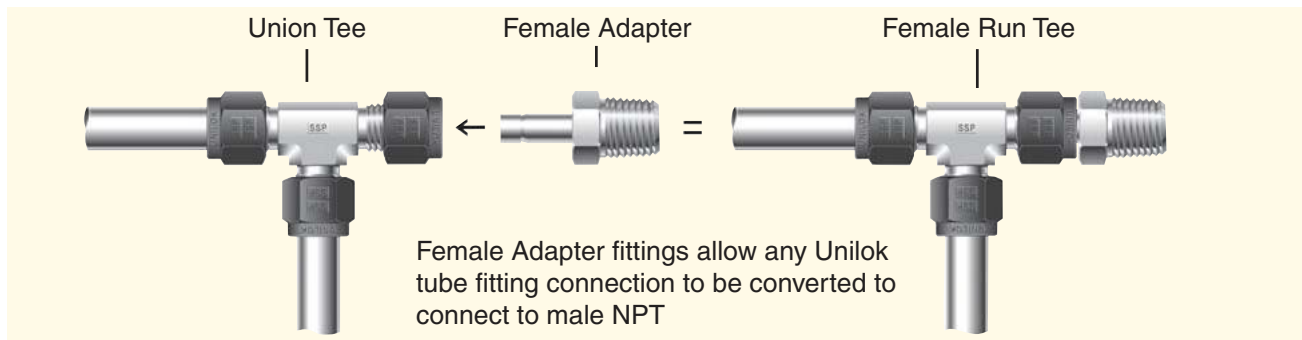

Finger-tight assembly dimensions (shown in inches) are for reference only and subject to change.

When ordering, specify material designator with part number (see page 3 for complete ordering information).

Tube Stub Connectors / Adapters

PC/RPC



See special installation instructions below

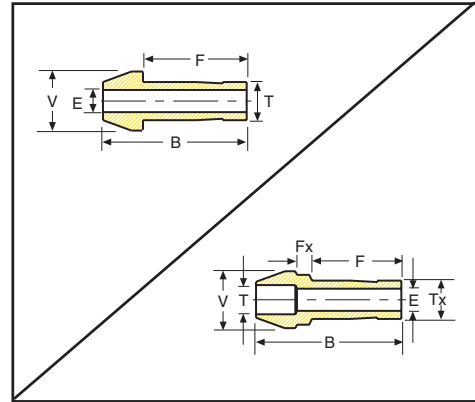

Port Connector

Unilok Part #	T Tube O.D.	B	E Minimum Opening	F	V
U1PC	1/16	0.54	0.02	0.42	0.13
U2PC	1/8	0.88	0.06	0.62	0.24
U4PC	1/4	0.97	0.11	0.74	0.37
U5PC	5/16	1.02	0.18	0.79	0.43
U6PC	3/8	1.03	0.24	0.80	0.50
U8PC	1/2	1.41	0.33	1.02	0.62
U12PC	3/4	1.47	0.51	1.09	0.87
U16PC	1	1.89	0.75	1.36	1.12

Reducing Port Connector

Unilok Part #	T Tube O.D.	Tx Reduced Tube O.D.	B	E Minimum Opening	F	Fx	V
U2RPC1	1/8	1/16	0.68	0.02	0.34	0.08	0.24
U4RPC1	1/4	1/16	0.71	0.02	0.34	0.14	0.37
U4RPC2	1/4	1/8	0.89	0.06	0.53	0.13	0.37
U6RPC2	3/8	1/8	0.91	0.08	0.53	0.15	0.50
U6RPC4	3/8	1/4	0.98	0.15	0.62	0.13	0.50
U8RPC4	1/2	1/4	1.15	0.15	0.62	0.15	0.62
U8RPC6	1/2	3/8	1.20	0.24	0.69	0.13	0.62
U12RPC8	3/4	1/2	1.44	0.34	0.91	0.15	0.87

Port connectors are used to close connect two Unilok tube fitting ports.

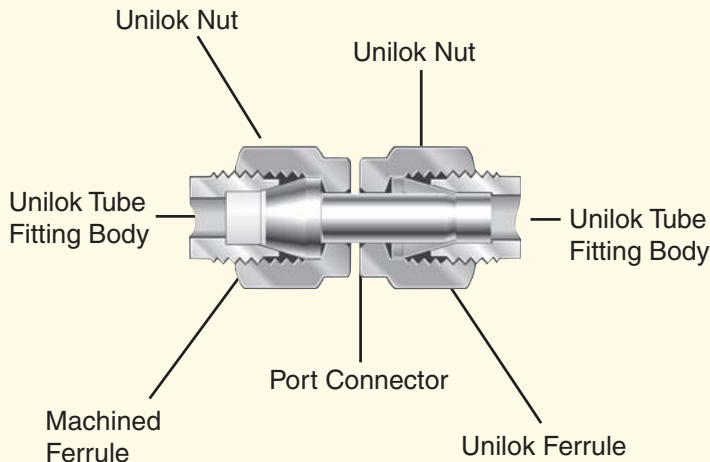

Installation Instructions for Port Connectors

- 1A. Remove the Unilok nut and ferrule from the first of the Unilok tube fitting parts to be close connected.
- 1B. Slide the Unilok nut (no ferrule) over the machined ferrule end of the port connector.
- 1C. Insert the machined ferrule end of the port connector into the Unilok tube fitting port and hand tighten the Unilok nut.
- 1D. While holding the tube fitting body steady with a back up wrench, tighten the Unilok nut with a wrench 1/4 turn.
2. Insert opposite end of the port connector into the second tube fitting port, hand tighten the Unilok nut, and while holding the tube fitting body steady with a back up wrench; wrench tighten the Unilok nut 1-1/4 turns for sizes 1/4" - 1" and 3/4 turn for sizes 1/16" - 3/16".

Finger-tight assembly dimensions (shown in inches) are for reference only and subject to change.

When ordering, specify material designator with part number (see page 3 for complete ordering information).

Tube Stub Connectors / Adapters

HBA

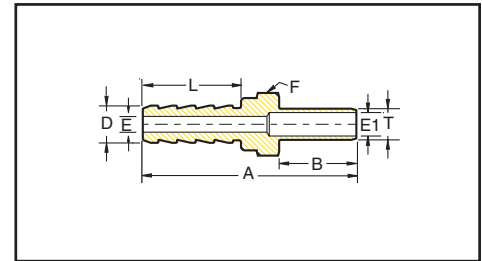

Hose Barb Adapter

Unilok Part Number	Hose I.D.	T Tube Size	A	B	D Dia.	E	E1	F Hex Flat	L
U2HBA2	1/8	1/8	1.35	0.53	0.15	0.08	0.09	5/16	0.40
U2HBA4	1/8	1/4	1.44	0.62	0.15	0.08	0.19	3/8	0.40
U4HBA4	1/4	1/4	1.83	0.62	0.30	0.19	0.19	7/16	0.79
U4HBA6	1/4	3/8	1.90	0.70	0.30	0.19	0.28	7/16	0.79
U5HBA4	5/16	1/4	1.91	0.62	0.37	0.19	0.19	7/16	0.87
U6HBA6	3/8	3/8	1.98	0.70	0.45	0.30	0.28	9/16	0.87
U6HBA8	3/8	1/2	2.20	0.96	0.45	0.30	0.39	5/8	0.87
U8HBA6	1/2	3/8	2.05	0.70	0.60	0.38	0.28	11/16	0.94
U8HBA8	1/2	1/2	2.27	0.96	0.60	0.38	0.39	11/16	0.94
U12HBA12	3/4	3/4	2.44	1.02	0.90	0.63	0.59	1-1/16	1.05

Heat code material traceability is available on Unilok tube fittings.

Tube Stub Connectors / Adapters

CU1

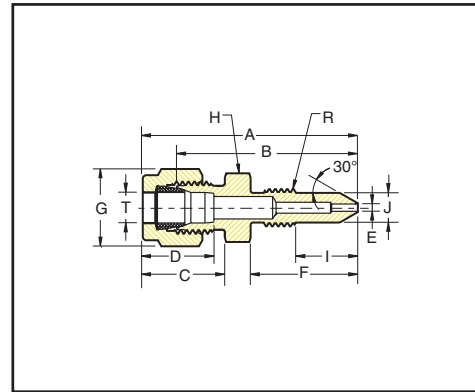
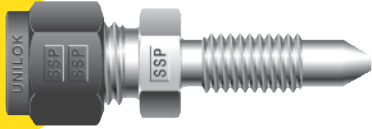

Calibration Union

Unilok Part #	T Tube O.D.	A	B	C	D	E Minimum Opening	F	G Nut Hex	H Body Hex	I	J	R Thread
U4CU1	1/4	1.69	1.40	0.70	0.60	.06	.78	9/16	1/2	.43	.20	1/4-28 UNF

CU2

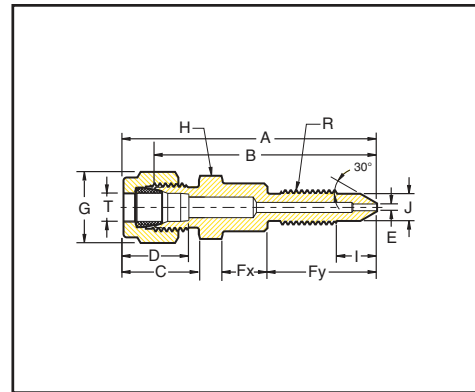
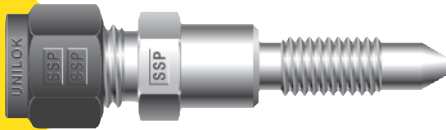

Calibration Union

Unilok Part #	T Tube O.D.	A	B	C	D	E Minimum Opening	Fx	Fy	G Nut Hex	H Body Hex	I	J	R Thread
U4CU2	1/4	2.32	2.03	0.70	0.60	.06	.41	1	9/16	1/2	.40	.25	5/16-24 UNF

SSP Instrumentation Calibration Unions streamline the typical DP transmitter calibration process and are available in 1/4" OD tubing by 1/4-28 straight thread, and 1/4" OD tubing by 5/16-24 straight thread. Calibration unions screw directly into plug/bleed port fittings, eliminating the possibility of galling the transmitter's NPT threads. Standard fitting material is 316 stainless steel. For more information, contact your local distributor.

Finger-tight assembly dimensions (shown in inches) are for reference only and subject to change.

When ordering, specify material designator with part number (see page 3 for complete ordering information).

Unilok to 37° Flare (AN)

ANU

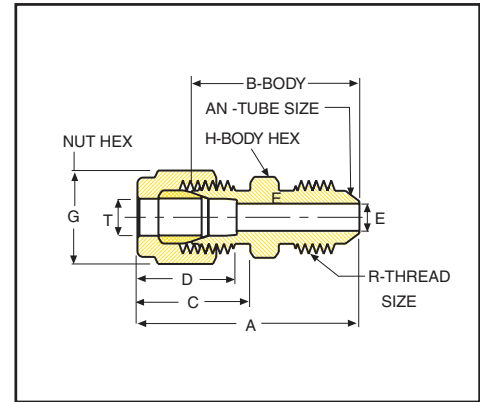
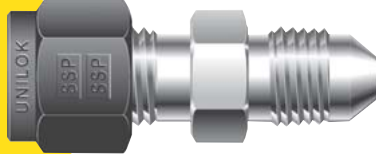

AN Union

Unilok Part #	T Tube O.D.	AN Tube Flare Size	A	B	C	D	E Minimum Opening	G	H	R
U1ANU2	1/16	1/8	1.07	0.92	0.43	0.34	0.05	5/16	7/16	5/16 - 24 UNJF-3
U2ANU2	1/8	1/8	1.27	1.01	0.60	0.50	0.06	7/16	7/16	5/16 - 24 UNJF-3
U2ANU4	1/8	1/4	1.38	1.12	0.60	0.50	0.09	7/16	1/2	7/16 - 20 UNJF-3
U4ANU4	1/4	1/4	1.48	1.19	0.70	0.60	0.17	9/16	1/2	7/16 - 20 UNJF-3
U5ANU5	5/16	5/16	1.51	1.22	0.73	0.64	0.23	5/8	9/16	1/2 - 20 UNJF-3
U6ANU4	3/8	1/4	1.56	1.27	0.76	0.66	0.17	11/16	5/8	7/16 - 20 UNJF-3
U6ANU6	3/8	3/8	1.56	1.27	0.76	0.66	0.28	11/16	5/8	9/16 - 18 UNJF-3
U8ANU8	1/2	1/2	1.81	1.41	0.86	0.90	0.39	7/8	13/16	3/4 - 16 UNJF-3
U12ANU12	3/4	3/4	2.10	1.70	0.86	0.96	0.61	1-1/8	1-1/8	1-1/16 - 12 UNJ-3
U16ANU16	1	1	2.42	1.94	1.04	1.23	0.84	1-1/2	1-3/8	1-5/16 - 12 UNJ-3

ANBU

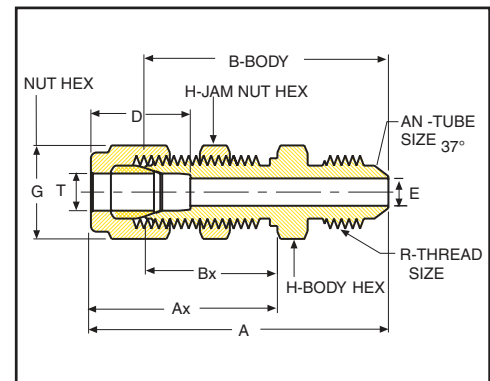

AN Bulkhead Union

Unilok Part #	T Tube O.D.	AN Tube Flare Size	A	Ax	B	Bx	D	E Minimum Opening	G	H	R	Maximum Panel Thickness	Panel Hole Drill Size
U4ANBU4	1/4	1/4	2.12	1.32	1.83	1.03	0.60	0.17	9/16	5/8	7/16 - 20 UNJF-3	0.40	29/64
U6ANBU6	3/8	3/8	2.25	1.45	1.96	1.16	0.66	0.28	11/16	3/4	9/16 - 18 UNJF-3	0.44	37/64
U8ANBU8	1/2	1/2	2.59	1.65	2.19	1.25	0.90	0.39	7/8	15/16	3/4 - 16 UNJF-3	0.50	49/64
U12ANBU12	3/4	3/4	3.11	1.87	2.71	1.47	0.96	0.61	1-1/8	1 3/16	1 1/16 - 12 UNJ-3	0.66	1-1/64
U16ANBU16	1	1	3.64	2.26	3.16	1.78	1.23	0.84	1-1/2	1 5/8	1 5/16 - 12 UNJ-3	0.75	1-21/64

Finger-tight assembly dimensions (shown in inches) are for reference only and subject to change.

When ordering, specify material designator with part number (see page 3 for complete ordering information).

Unilok to 37° Flare (AN)

ANF

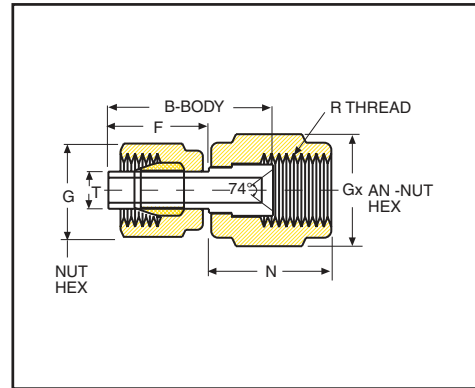

Female AN Adapter*

Unilok Part #	T Tube O.D.	AN Flare Size	B	F	G Hex Flat	Gx Hex Flat	N	R AN Thread Size
U2ANF2	1/8	1/8	0.75	0.53	7/16	3/8	0.54	5/16-24 UNJF-3
U2ANF4	1/8	1/4	0.78	0.53	7/16	9/16	0.62	7/16-20 UNJF-3
U4ANF4	1/4	1/4	0.86	0.62	9/16	9/16	0.62	7/16-20 UNJF-3
U6ANF6	3/8	3/8	1.02	0.70	11/16	11/16	0.72	9/16-18 UNJF-3
U8ANF8	1/2	1/2	1.31	0.92	7/8	7/8	0.85	3/4-16 UNJF-3

* Follow Reassembly Instructions from page 9 for assembly of the Unilok end of the ANF fitting.

ANA

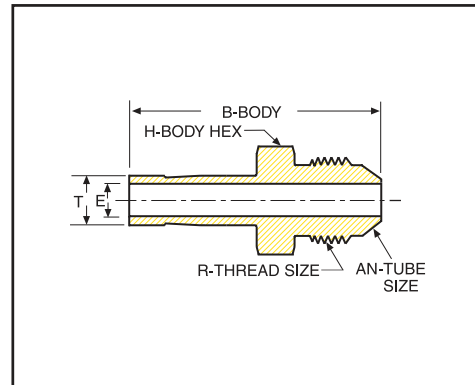
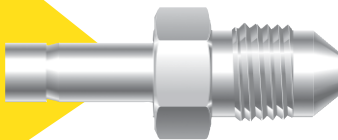

AN Adapter

Unilok Part #	T Tube O.D.	AN Tube Flare Size	B Body Length	R AN Thread Size	E Minimum Opening	H Hex Flat
U4ANA4	1/4	1/4	1.46	7/16-20 UNJF-3	0.17	1/2
U6ANA4	3/8	1/4	1.53	7/16-20 UNJF-3	0.17	1/2
U6ANA6	3/8	3/8	1.56	9/16-18 UNJF-3	0.26	5/8
U8ANA8	1/2	1/2	1.91	3/4-16 UNJF-3	0.36	13/16
U12ANA12	3/4	3/4	2.21	1-1/16-12 UNJ-3	0.59	1-1/8
U16ANA16	1	1	2.58	1-5/16-12 UNJ-3	0.82	1-3/8

Finger-tight assembly dimensions (shown in inches) are for reference only and subject to change.

When ordering, specify material designator with part number (see page 3 for complete ordering information).

Tube to O-Ring Seal

O-Ring Seal Connectors

Unilok O-Ring Seal Connectors provide a leak-tight seal in vacuum or pressure systems having tapered pipe or straight thread ports and a smooth, flat seat surface perpendicular to the axis of the threads. (See Figures 1-3.) To produce an effective seal, the connectors are manufactured with a precision groove that retains the O-Ring and prevents its extrusion from the sealing area. The connectors are designed to seal upon a raised, flat surface or with a counter bored or recessed hole. The following O-Ring Seal installation instructions and mounting dimensions chart should be helpful when working with O-Ring Seal Connectors.

O-Ring Seal Connector Installation Instructions

1. Lubricate the O-Ring with a lubricant that is compatible with the O-Ring material and the system's media and environment. (Standard O-Ring material is BUNA compound, 70 Durometer. Viton and other O-Ring compounds are available.)
2. Hand tighten the connector until the O-Ring begins to compress.
3. With a wrench, slightly snug the connector to compress the O-Ring to the port and achieve the seal.
4. When connecting or disconnecting tubing to the Unilok fitting end of the connector, always use a back-up wrench to retain the connector's installed position.

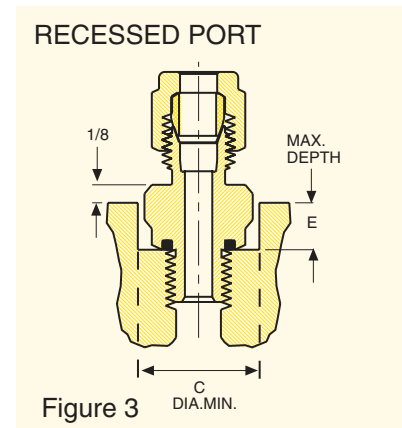
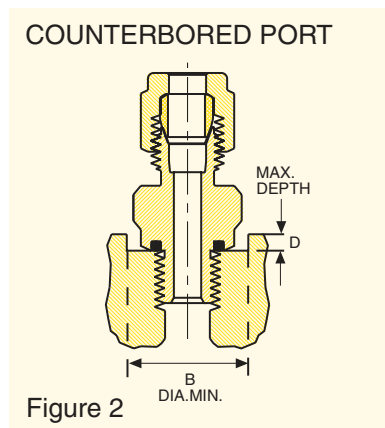
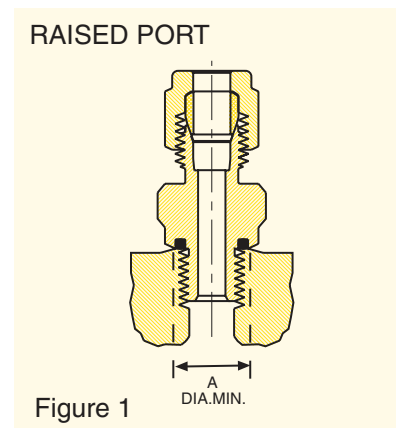

MOUNTING DIMENSIONS FOR O-RING SEAL CONNECTORS						
Pipe Thread Size	Straight Thread Size	Diameters			Depths	
		A Minimum Flat Surface for Sealing	B Minimum	C Minimum	D Maximum	E Maximum
1/8 NPT	—	0.69	0.78	0.88	0.16	0.28
1/4 NPT	—	0.87	0.97	1.09	0.16	0.31
3/8 NPT	—	1.00	1.16	1.31	0.16	0.34
1/2 NPT	—	1.00	1.34	1.53	0.22	0.44
—	5/16 - 24	0.50	0.59	0.66	0.09	0.16
—	3/8 - 24	0.56	0.66	0.75	0.09	0.22
—	7/16 - 20	0.69	0.78	0.88	0.16	0.28
—	1/2 - 20	0.75	0.91	1.03	0.16	0.31
—	9/16 - 18	0.81	0.97	1.09	0.16	0.31
—	3/4 - 16	1.00	1.16	1.31	0.16	0.34
—	1-1/16 - 12	1.41	1.53	1.75	0.22	0.50
—	1-5/16 - 12	1.69	1.78	2.03	0.22	0.56

Tube to O-Ring Seal

OMC

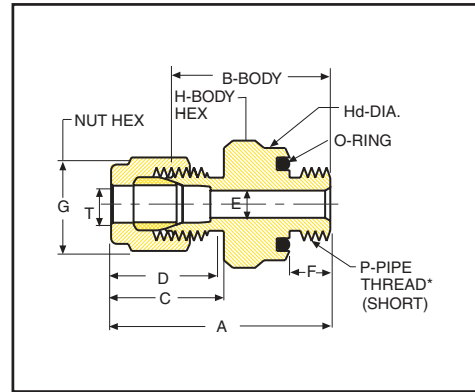

O-Ring Seal Male Connector (Connects to Female Short NPT Thread)

Unilok Part #	T Tube O.D.	P-NPT* Male Pipe Size	A	B	C	D	E Minimum Opening	F	G	H	HD	AS568 O-Ring Uniform Size Number**
U2OMC2	1/8	1/8	1.29	1.03	0.60	0.50	0.09	0.28	7/16	3/4	0.74	-111
U4OMC2	1/4	1/8	1.38	1.09	0.70	0.60	0.19	0.28	9/16	3/4	0.74	-111
U4OMC4	1/4	1/4	1.51	1.22	0.70	0.60	0.19	0.38	9/16	15/16	0.93	-113
U6OMC4	3/8	1/4	1.57	1.28	0.76	0.66	0.28	0.38	11/16	15/16	0.93	-113
U6OMC6	3/8	3/8	1.63	1.34	0.76	0.66	0.28	0.41	11/16	1-1/8	1.12	-116
U6OMC8	3/8	1/2	1.85	1.56	0.76	0.66	0.28	0.53	11/16	1-5/16	1.3	-212
U8OMC8	1/2	1/2	1.96	1.56	0.86	0.90	0.41	0.53	7/8	1-5/16	1.3	-212

* Modified Male NPT to Allow O-Ring Seal Connection

** 70 Durometer BUNA compound O-Ring is standard. Other O-Ring compounds are available.

OSC

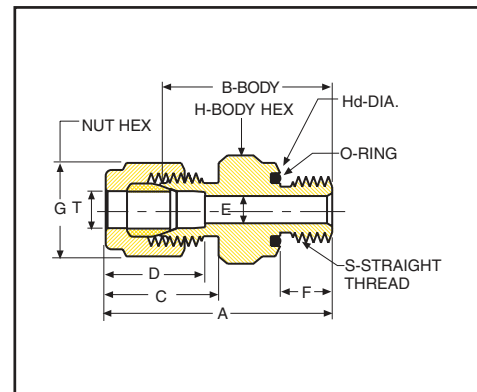

O-Ring Seal Male Straight Thread Connector (Connects to Female Straight Thread)

Unilok Part #	T Tube O.D.	S Thread Size	A	B	C	D	E minimum Opening	F	G	H	Hd	AS568 O-Ring Uniform Size Number*
U1OSC2	1/16	5/16 - 24	1.05	0.90	0.43	0.34	0.05	0.34	5/16	9/16	0.55	-11
U2OSC2	1/8	5/16 - 24	1.29	1.03	0.60	0.50	0.09	0.34	7/16	9/16	0.55	-11
U3OSC3	3/16	3/8 - 24	1.35	1.09	0.63	0.54	0.12	0.38	1/2	5/8	0.62	-12
U4OSC4	1/4	7/16 - 20	1.51	1.22	0.70	0.60	0.19	0.41	9/16	3/4	0.74	-111
U5OSC5	5/16	1/2 - 20	1.60	1.31	0.73	0.64	0.25	0.44	5/8	7/8	0.86	-112
U6OSC6	3/8	9/16 - 18	1.67	1.38	0.76	0.66	0.28	0.47	11/16	15/16	0.93	-113
U8OSC8	1/2	3/4 - 16	1.81	1.41	0.86	0.90	0.41	0.47	7/8	1-1/8	1.12	-116
U12OSC12	3/4	1-1/16 - 12	2.06	1.66	0.86	0.96	0.62	0.56	1-1/8	1-1/2	1.49	-215
U16OSC16	1	1-5/16 - 12	2.29	1.81	1.04	1.23	0.88	0.56	1-1/2	1-3/4	1.74	-219

* 70 Durometer BUNA compound O-Ring is standard. Other O-Ring compounds are available.

Finger-tight assembly dimensions (shown in inches) are for reference only and subject to change.

When ordering, specify material designator with part number (see page 3 for complete ordering information).

Tube to SAE / MS

MCST



These fittings adapt to SAE/J1926 (Straight Thread Boss) and MS16142 (Boss).

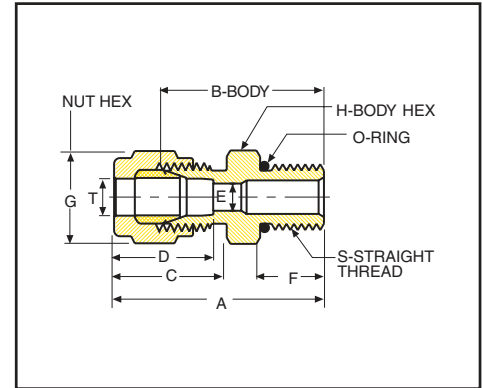

Male Connector - Straight Thread Boss

Unilok Part #	T Tube O.D.	S Thread Size	A	B	C	D	E Minimum Opening	F	G	H	AS568 O-Ring Uniform Size Number*
U2MCST2	1/8	5/16 - 24	1.18	0.92	0.60	0.50	0.09	0.30	7/16	7/16	-902
U4MCST4	1/4	7/16 - 20	1.34	1.05	0.70	0.60	0.19	0.36	9/16	9/16	-904
U4MCST6	1/4	9/16 - 18	1.40	1.11	0.70	0.60	0.19	0.39	9/16	11/16	-906
U4MCST8	1/4	3/4 - 16	1.48	1.19	0.70	0.60	0.19	0.44	9/16	7/8	-908
U4MCST10	1/4	7/8 - 14	1.60	1.31	0.70	0.60	0.19	0.50	9/16	1	-910
U5MCST5	5/16	1/2 - 20	1.37	1.08	0.73	0.64	0.25	0.36	5/8	5/8	-905
U6MCST4	3/8	7/16 - 20	1.40	1.11	0.76	0.66	0.20	0.36	11/16	5/8	-904
U6MCST6	3/8	9/16 - 18	1.46	1.17	0.76	0.66	0.28	0.39	11/16	11/16	-906
U6MCST8	3/8	3/4 - 16	1.54	1.25	0.76	0.66	0.28	0.44	11/16	7/8	-908
U6MCST10	3/8	7/8 - 14	1.66	1.37	0.76	0.66	0.28	0.50	11/16	1	-910
U8MCST6	1/2	9/16 - 18	1.54	1.14	0.86	0.90	0.28	0.39	7/8	13/16	-906
U8MCST8	1/2	3/4 - 16	1.65	1.25	0.86	0.90	0.41	0.44	7/8	7/8	-908
U8MCST10	1/2	7/8 - 14	1.77	1.37	0.86	0.90	0.41	0.50	7/8	1	-910
U8MCST12	1/2	1-1/16 - 12	1.93	1.53	0.86	0.90	0.41	0.59	7/8	1-1/4	-912
U10MCST8	5/8	3/4 - 16	1.65	1.25	0.86	0.96	0.42	0.44	1	15/16	-908
U10MCST10	5/8	7/8 - 14	1.78	1.38	0.86	0.96	0.50	0.50	1	1	-910
U12MCST8	3/4	3/4 - 16	1.81	1.41	0.86	0.96	0.42	0.44	1-1/8	1-1/16	-908
U12MCST12	3/4	1-1/16 - 12	1.93	1.53	0.86	0.96	0.62	0.59	1-7/8	1-1/4	-912
U14MCST14	7/8	1-3/16 - 12	1.93	1.53	0.86	1.02	0.72	0.59	1-1/4	1-3/8	-914
U16MCST12	1	1-1/16 - 12	2.10	1.62	1.04	1.23	0.66	0.59	1-1/2	1-3/8	-912
U16MCST16	1	1-5/16 - 12	2.14	1.66	1.04	1.23	0.88	0.59	1-1/2	1-1/2	-916

*90 Durometer Viton O-Ring is standard. Other O-Ring compounds are available.

Tube to SAE / MS

MEST

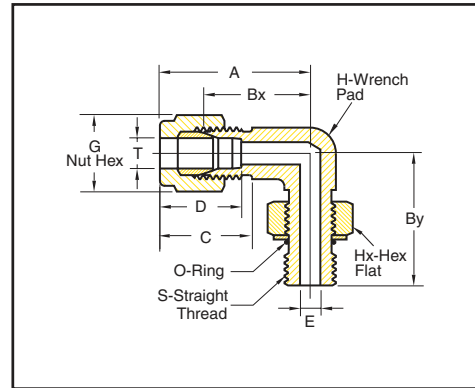
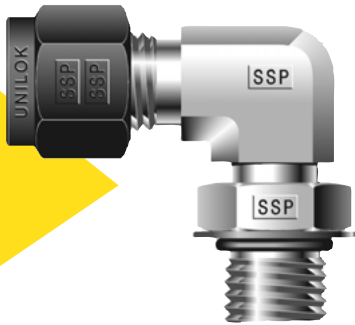

Male Elbow - Straight Thread Boss

Unilok Part #	T Tube O.D.	S SAE/MS Thread Size	A	C	D	E Min. Opening	H Wrench Pad	Hx Hex Flat	G Hex Flat	Bx	By	AS568 O-Ring Uniform Size Number*
U4MEST4	1/4	7/16-20	1.12	0.70	0.60	0.19	1/2	9/16	9/16	0.83	1.12	-904
U4MEST6	1/4	9/16-18	1.20	0.70	0.60	0.19	5/8	11/16	9/16	0.91	1.27	-906
U5MEST5	5/16	1/2-20	1.19	0.73	0.64	0.23	9/16	5/8	5/8	0.90	1.16	-905
U6MEST4	3/8	7/16-20	1.26	0.76	0.66	0.28	9/16	9/16	11/16	0.97	1.15	-904
U6MEST6	3/8	9/16-18	1.26	0.76	0.66	0.28	9/16	11/16	11/16	0.97	1.27	-906
U6MEST8	3/8	3/4-16	1.37	0.76	0.66	0.28	3/4	7/8	11/16	1.08	1.49	-908
U8MEST6	1/2	9/16-18	1.48	0.86	0.90	0.41	3/4	11/16	7/8	1.08	1.27	-906
U8MEST8	1/2	3/4-16	1.48	0.86	0.90	0.41	13/16	7/8	7/8	1.08	1.49	-908
U10MEST10	5/8	7/8-14	1.56	0.86	0.96	0.50	15/16	1	1	1.16	1.71	-910
U12MEST12	3/4	1-1/16 - 12	1.63	0.86	0.96	0.62	1-1/16	1-1/4	1-1/8	1.23	1.92	-912
U16MEST16	1	1-5/16 - 12	1.99	1.04	1.23	0.88	1-3/8	1-1/2	1-1/2	1.51	2.11	-916

*90 Durometer Viton O-Ring is standard. Other O-Ring compounds are available.

M45EST

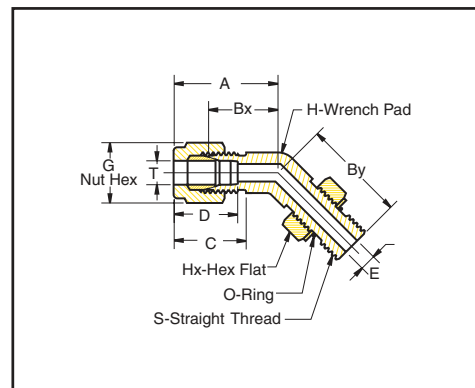
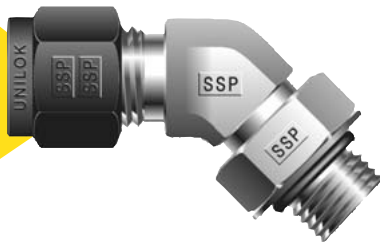

45° Male Elbow - Straight Thread Boss

Unilok Part #	T Tube O.D.	S SAE/MS Thread Size	A	C	D	E Min. Opening	H Wrench Pad	Hx Hex Flat	G Hex Flat	Bx	By	AS568 O-Ring Uniform Size Number*
U4M45EST4	1/4	7/16-20	1.01	0.70	0.60	0.19	1/2	9/16	9/16	0.72	1.01	-904
U6M45EST6	3/8	9/16-18	1.10	0.76	0.66	0.28	5/8	11/16	11/16	0.81	1.11	-906
U8M45EST8	1/2	3/4-16	1.26	0.86	0.90	0.41	13/16	7/8	7/8	0.86	1.27	-908
U12M45EST12	3/4	1-1/16 - 12	1.57	0.86	0.96	0.62	1-1/8	1-1/4	1-1/8	1.17	1.86	-912
U16M45EST16	1	1-5/16 - 12	1.87	1.04	1.23	0.88	1-3/8	1-1/2	1-1/2	1.39	1.99	-916

*90 Durometer Viton O-Ring is standard. Other O-Ring compounds are available.

Finger-tight assembly dimensions (shown in inches) are for reference only and subject to change.

When ordering, specify material designator with part number (see page 3 for complete ordering information).

Tube to SAE / MS

MBTST

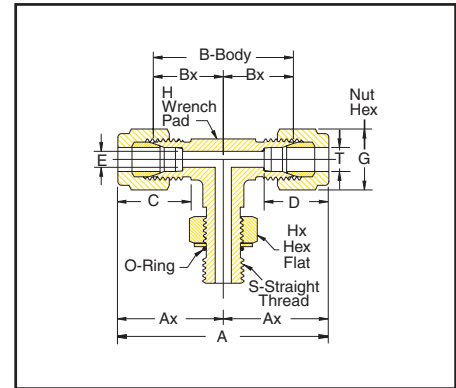
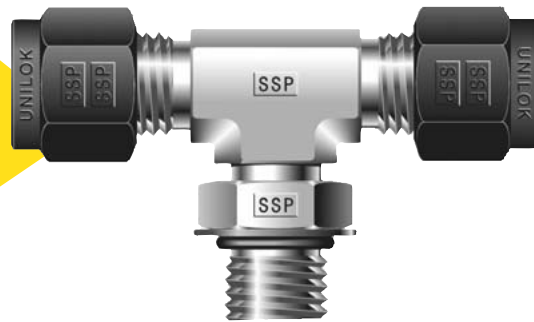

Male Branch Tee - Straight Thread Boss

Unilok Part #	T Tube O.D.	S SAE/MS Thread Size	A	Ax	C	D	E Min. Opening	H Wrench Pad	Hx Hex Flat	G Hex Flat	B	Bx	AS568 O-Ring Uniform Size Number*
U4MBTST4	1/4	7/16-20	2.24	1.12	0.70	0.60	0.19	1/2	9/16	9/16	1.66	0.83	-904
U6MBTST6	3/8	9/16-18	2.52	1.26	0.76	0.66	0.28	5/8	11/16	11/16	1.94	0.97	-906
U8MBTST8	1/2	3/4-16	2.96	1.48	0.86	0.90	0.41	13/16	7/8	7/8	2.16	1.08	-908
U12MBTST12	3/4	1-1/16 - 12	3.26	1.63	0.86	0.96	0.62	1-1/16	1-1/4	1-1/8	2.46	1.23	-912
U16MBTST16	1	1-5/16 - 12	3.98	1.99	1.04	1.23	0.88	1-3/8	1-1/2	1-1/2	3.02	1.51	-916

*90 Durometer Viton O-Ring is standard. Other O-Ring compounds are available.

MRTST

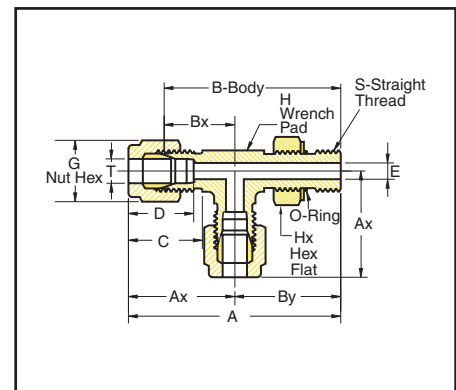
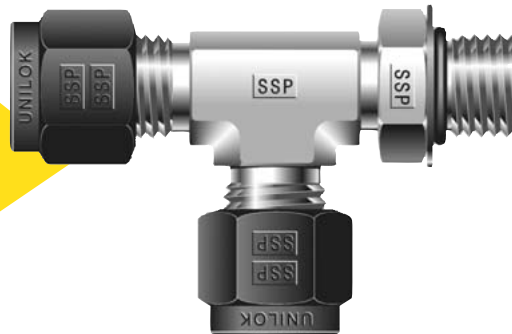

Male Run Tee - Straight Thread Boss

Unilok Part #	T Tube O.D.	S SAE/MS Thread Size	A	Ax	C	D	E Min. Opening	H Wrench Pad	Hx Hex Flat	G Hex Flat	B	Bx	By	AS568 O-Ring Uniform Size Number*
U4MRTST4	1/4	7/16-20	2.24	1.12	0.70	0.60	0.19	1/2	9/16	9/16	1.95	0.83	1.12	-904
U6MRTST6	3/8	9/16-18	2.53	1.26	0.76	0.66	0.28	5/8	11/16	11/16	2.24	0.97	1.27	-906
U8MRTST8	1/2	3/4-16	2.97	1.48	0.86	0.90	0.41	13/16	7/8	7/8	2.57	1.08	1.49	-908
U12MRTST12	3/4	1-1/16 - 12	3.55	1.63	0.86	0.96	0.62	1-1/16	1-1/4	1-1/8	3.15	1.23	1.92	-912
U16MRTST16	1	1-5/16 - 12	4.10	1.99	1.04	1.23	0.88	1-3/8	1-1/2	1-1/2	3.62	1.51	2.11	-916

*90 Durometer Viton O-Ring is standard. Other O-Ring compounds are available.

Finger-tight assembly dimensions (shown in inches) are for reference only and subject to change.

When ordering, specify material designator with part number (see page 3 for complete ordering information).

Tube to SAE / MS

MAST

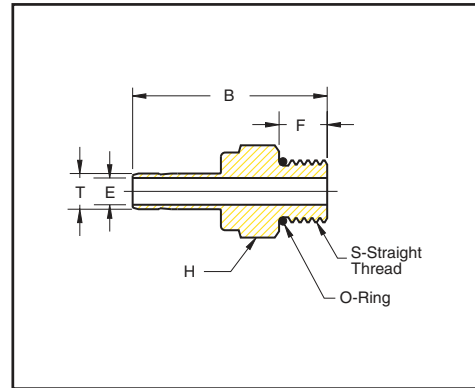
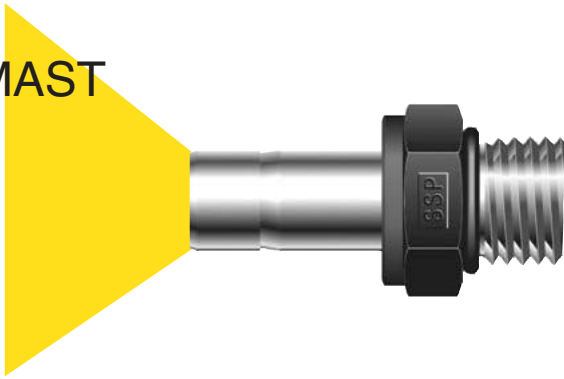

Male Adapter - Straight Thread Boss

Unilok Part #	T Tube O.D.	S SAE/MS Thread Size	B	F	E Min. Opening	H Hex Flat	AS568 O-Ring Uniform Size Number*
U2MAST2	1/8	5/16-24	1.20	0.30	0.09	7/16	-902
U4MAST4	1/4	7/16-20	1.39	0.36	0.19	9/16	-904
U6MAST4	3/8	7/16-20	1.46	0.36	0.19	9/16	-904
U6MAST6	3/8	9/16-18	1.52	0.39	0.28	11/16	-906
U6MAST8	3/8	3/4-16	1.60	0.44	0.28	7/8	-908
U8MAST6	1/2	9/16-18	1.74	0.39	0.39	11/16	-906
U8MAST8	1/2	3/4-16	1.82	0.44	0.39	7/8	-908
U12MAST12	3/4	1-1/16-12	2.10	0.59	0.59	1-1/4	-912
U16MAST16	1	1-5/16-12	2.41	0.59	0.80	1-1/2	-916

*90 Durometer Viton O-Ring is standard. Other O-Ring compounds are available.

Cap and Plug

CP



Caps are used for capping an end of a tubing run.

Cap

Unilok Part #	T Tube O.D.	A	B	C	D	G	H
U1CP	1/16	0.59	0.44	0.43	0.34	5/16	5/16
U2CP	1/8	0.79	0.53	0.60	0.50	7/16	7/16
U3CP	3/16	0.84	0.58	0.63	0.54	1/2	7/16
U4CP	1/4	0.92	0.63	0.70	0.60	9/16	1/2
U5CP	5/16	0.96	0.67	0.73	0.64	5/8	9/16
U6CP	3/8	1.01	0.72	0.76	0.66	11/16	5/8
U8CP	1/2	1.15	0.75	0.86	0.90	7/8	13/16
U10CP	5/8	1.18	0.78	0.86	0.96	1	15/16
U12CP	3/4	1.24	0.84	0.86	0.96	1-1/8	1-1/16
U14CP	7/8	1.34	0.94	0.86	1.02	1-1/4	1-3/16
U16CP	1	1.51	1.03	1.04	1.23	1-1/2	1-3/8

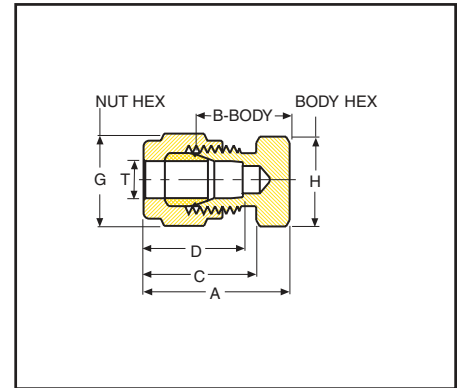

Cap Installation Instructions

The standard Unilok tube fitting installation instructions apply for proper installation of caps (see page 9).



P



Plugs are used to plug an unused port of a Unilok tube fitting.

Plug

Unilok Part #	T Tube O.D.	G
U1P	1/16	5/16
U2P	1/8	7/16
U3P	3/16	1/2
U4P	1/4	9/16
U5P	5/16	5/8
U6P	3/8	11/16
U8P	1/2	7/8
U10P	5/8	1
U12P	3/4	1-1/8
U16P	1	1-1/2

Plug Installation Instructions

1. Remove the nut and ferrule from the port of the tube fitting body to be plugged and replace with the Unilok plug.
2. Hand-tighten the Unilok plug and then while holding the tube fitting body steady with a back-up wrench, use a wrench to tighten the Unilok plug only 1/4 of a turn.

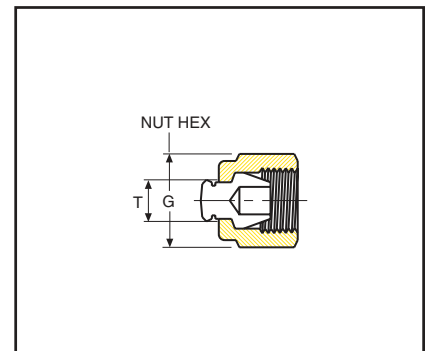

Finger-tight assembly dimensions (shown in inches) are for reference only and subject to change.

When ordering, specify material designator with part number (see page 3 for complete ordering information).

Components

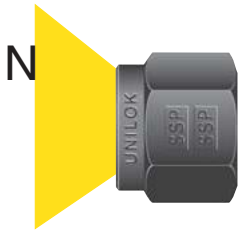

Nut

Unilok Part #	T Tube O.D.	G	L
U1N	1/16	5/16	0.31
U2N	1/8	7/16	0.47
U3N	3/16	1/2	0.47
U4N	1/4	9/16	0.50
U5N	5/16	5/8	0.53
U6N	3/8	11/16	0.56
U8N	1/2	7/8	0.69
U10N	5/8	1	0.69
U12N	3/4	1-1/8	0.69
U14N	7/8	1-1/4	0.69
U16N	1	1-1/2	0.81

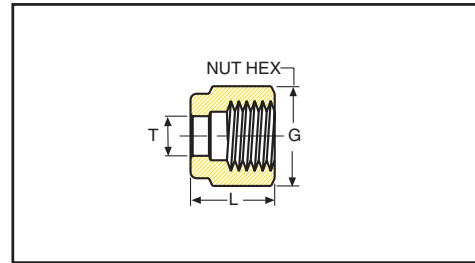

Knurled Nut

Unilok Part #	T Tube O.D.	G	L
U1KN	1/16	5/16	0.31
U2KN	1/8	7/16	0.47
U3KN	3/16	1/2	0.47
U4KN	1/4	9/16	0.50
U5KN	5/16	5/8	0.53
U6KN	3/8	11/16	0.56
U8KN	1/2	7/8	0.69
U10KN	5/8	1	0.69
U12KN	3/4	1-1/8	0.69
U14KN	7/8	1-1/4	0.69
U16KN	1	1-1/2	0.81

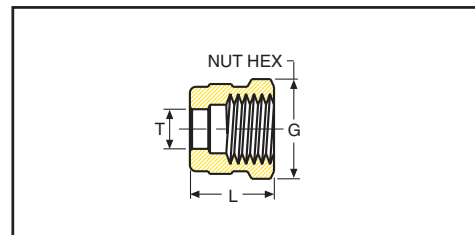

The knurled nut is designed for use with fittings used in applications where it has been determined by the user that a finger tight assembly procedure is acceptable. Typical applications include low pressure laboratory use of plastic tubing.

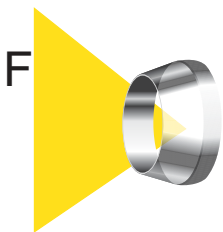

Ferrule

Unilok Part #	T Tube O.D.
U1F	1/16
U2F	1/8
U3F	3/16
U4F	1/4
U5F	5/16
U6F	3/8
U8F	1/2
U10F	5/8
U12F	3/4
U14F	7/8
U16F	1

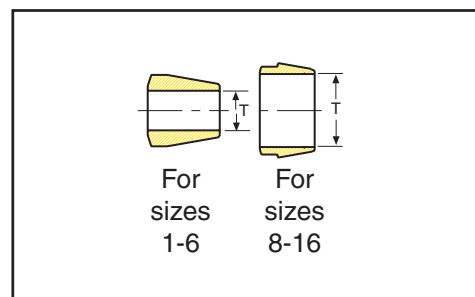

Finger-tight assembly dimensions (shown in inches) are for reference only and subject to change.

When ordering, specify material designator with part number (see page 3 for complete ordering information).

Components

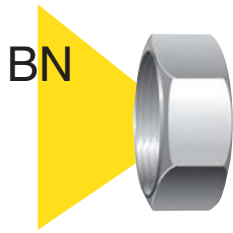

Bulkhead Locknut

Unilok Part #	T Tube O.D.	A	H
U1BN	1/16	0.13	5/16
U2BN	1/8	0.22	1/2
U3BN	3/16	0.22	9/16
U4BN	1/4	0.22	5/8
U5BN	5/16	0.28	11/16
U6BN	3/8	0.27	3/4
U8BN	1/2	0.31	15/16
U10BN	5/8	0.36	1-1/16
U12BN	3/4	0.41	1-3/16
U14BN	7/8	0.41	1-3/8
U16BN	1	0.41	1-5/8

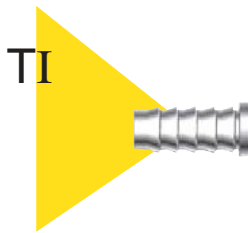
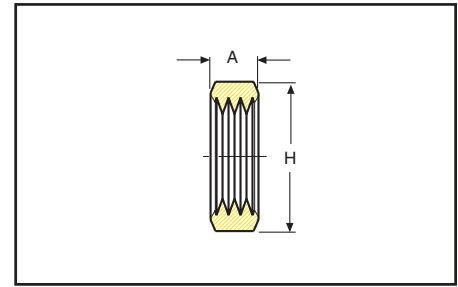

Tube Insert

Unilok Part #	Tube O.D.	Tube I.D.	E I.D. of Bore
U3T12	3/16	1/8	0.09
U4T12	1/4	1/8	0.09
U4T1170	1/4	0.170	0.11
U4T13	1/4	3/16	0.14
U5T12	5/16	1/8	0.09
U5T13	5/16	3/16	0.12
U5T14	5/16	1/4	0.19
U6T13	3/8	3/16	0.12
U6T14	3/8	1/4	0.19
U8T14	1/2	1/4	0.19
U8T16	1/2	3/8	0.31
U10T16	5/8	3/8	0.31
U10T18	5/8	1/2	0.44
U12T18	3/4	1/2	0.44
U12T110	3/4	5/8	0.56
U16T112	1	3/4	0.69

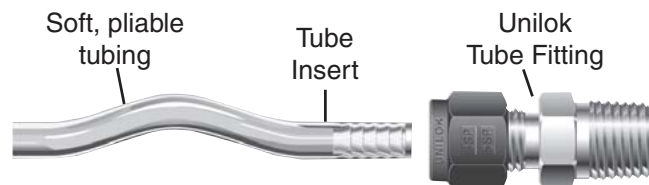
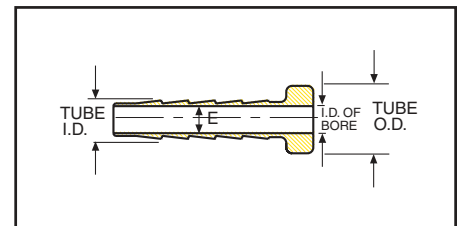

In general, Unilok tube fittings may be used with a variety of plastic tube materials without any special preparations. However, very soft-wall, pliable tubing such as Tygon® needs a tube insert for support prior to insertion in the Unilok tube fitting. The standard Unilok tube fitting installation instructions (see page 9) are then followed for proper make-up.

Finger-tight assembly dimensions (shown in inches) are for reference only and subject to change.

When ordering, specify material designator with part number (see page 3 for complete ordering information).

Selection Guide for Instrumentation Fittings & Tubing

SSP flareless instrumentation quality tube fittings have been designed and manufactured to provide reliable leak free connections in a wide variety of applications. The design characteristics of the tube fittings compensate for many of the field variables involved in the installation of the tube fittings and with the tolerances, wall thickness, finish and quality of the tubing. A reliable leak free tubing system will be achieved by combining the proper selection and handling of tubing with the proper tube fitting selection and installation. The following information is provided to assist in the tube selection process.

MATERIAL

The tubing material chosen must be compatible with the system's contained media, pressure and temperature, as well as with the environment in which it will be installed. Also, the tubing and tube fitting materials should be similar for optimum sealing action to occur (stainless fittings for stainless tube, brass fittings for copper tube, carbon steel fittings for carbon steel tube, etc.). The mixing and contact of dissimilar materials may leave the system susceptible to galvanic corrosion and/or not allow proper tube fitting makeup to be achieved. Additionally, the tube fittings have been designed and manufactured to function within the hardness ranges allowed for similar tubing materials by applicable ASTM specifications as referred to in Tables 1-4.

PRESSURE AND FLOW

The size of the tube's outside diameter (O.D.) and the necessary wall thickness are determined by the system's pressure and flow requirements. Tables 1-4 detail the suggested tubing sizes and wall thicknesses for use with instrumentation tube fittings. Additionally, the tables provide the maximum allowable working pressures for each size of tube recommended for use with instrumentation tube fittings. If no pressure is shown on the table for a particular size, the tube is not recommended for use with instrumentation tube fittings. The tubing system should not be utilized above the tube's maximum allowable working pressure; however, instrumentation tube fittings have been tested as leak tight to the burst pressure of the tubing in all recommended sizes and wall thicknesses.

TEMPERATURE

The system's operating temperature may affect the initial choice of tubing material and may also affect the maximum allowable working pressure for the given tube size (see Table 5 for temperature stress factors).

LIGHT GAS SERVICE

Light gases such as hydrogen, helium, nitrogen, etc. have extremely small molecules which can be released through the smallest of leak paths including tubing surface imperfections or defects. To provide a successful connection for light gas service, the tubing must have a thick enough wall to provide resistance for the setup action of the ferrules to further compensate for the tube's potential surface condition. Tables 1-4 show the tubing sizes and wall thicknesses recommended for light gas service.

HANDLING AND INSTALLATION

Surface scratches and gouges on tubing are a source of potential leaks. Some precaution when handling the tubing can help reduce surface scratches and maintain the surface finish as originally intended by the manufacturer. Tubing should never be dragged across rocks, blacktop, pavement, or the tubing storage rack as scratches and gouges can occur. Sharp blades should always be used in the tube cutters or hacksaws used to cut the tubing so as to provide a clean, square cut. Dull cutting blades can cause internal and external hanging burrs, and cause the tubing to become oval and affect proper insertion within the fitting. As a good handling practice, tubing should always be deburred prior to tube fitting installation to help assure easy and complete tube insertion. Additionally, for bent tube assemblies, it is important to bend tubing prior to installing tube fittings, and to provide a sufficient straight length of tubing after the bend to allow the tube to be fully inserted into the fitting. See Figure A and Table 7 on page 53 for additional information. Also, to eliminate weight stress from the tubing upon the fitting and to provide additional system support for vibration and thermal shock resistance, the tubing should always be supported by tube hangers, clamps or trays.

Selection Guide for Instrumentation Fittings & Tubing

STAINLESS STEEL TUBING - TABLE 1																	
Maximum Allowable Working Pressure (PSIG)																	
Tube O.D. Size (in.)	Wall Thickness of Tube (Inches)																
	.010	.012	.014	.016	.020	.028	.035	.049	.065	.083	.095	.109	.120	.134	.156	.188	
1/16	5600	6850	8150	9500	12100												
1/8						8550	11000										
3/16						5450	7000	10300									
1/4						4000	5100	7500	10300								
5/16							4050	5850	8050								
3/8							3300	4800	6550								
1/2							2450	3500	4750	6250							
5/8								2950	4000	5200	6050						
3/4								2400	3300	4250	4950	5800					
7/8								2050	2800	3600	4200	4850					
1									2400	3150	3650	4200	4700				
1-1/4										2450	2850	3300	3650	4150	4900		
1-1/2											2350	2700	3000	3400	4000	4900	
2												2000	2200	2500	2900	3600	

Calculation Basis: Annealed, seamless 304 or 316 stainless steel tubing ASTM A-269 or equivalent. System temperatures between -20°F and 100°F with allowable stress of 20,000 psi. Ultimate tensile strength of 75,000 psi. Safety factor of 4.

Reference: ANSI B 31.3 Code. (For more specific working pressure information regarding a particular tubing, consult with the actual manufacturer of the tubing.)

Note: For welded and drawn tubing, a derating factor must be utilized. For double welded tube, multiply the above pressure rating by .85; and for single welded tube by .80 (ANSI B 31, Table A-1B).

Suggested Tube Ordering Information: Specify the outside diameter and wall thickness of annealed, seamless or welded and drawn 316 or 304 stainless steel tubing of ASTM A-269, A-249, A-213 or equivalent. Also specify high quality tubing to be free of scratches, and suited for bending with material hardness not to exceed Rb 90.

COPPER TUBING - TABLE 2								
Maximum Allowable Working Pressure (PSIG)								
Tube O.D. Size (in.)	Wall Thickness of Tube (Inches)							
	.028	.035	.049	.065	.083	.095	.109	.120
1/8	2700	3600						
3/16	1700	2225	3450					
1/4	1250	1600	2475	3475				
5/16		1250	1900	2675				
3/8		1050	1550	2150				
1/2		750	1150	1550	2050			
5/8			900	1200	1600	1850		
3/4			700	1000	1275	1500	1775	
7/8			600	850	1075	1250	1500	
1			550	700	950	1100	1300	1400

Calculation Basis: Annealed (Temper 060), seamless copper tubing ASTM B-75 or equivalent. System temperatures between -20°F and 100°F with allowable stress of 6000 psi. Ultimate tensile strength of 30,000 psi. Safety factor of 5.

Reference: ANSI B 31.3 Code. (For more specific working pressure information regarding a particular tubing, consult with the actual manufacturer of the tubing.)

Suggested Tube Ordering Information: Specify the outside diameter and wall thickness of annealed (Temper 060), seamless copper tubing of ASTM B-75, B-68, or equivalent specification. Also specify high quality tubing to be free of scratches, and suited for bending.

Additionally Acceptable: Annealed (Temper O) copper water tubing, Type K or Type L (ASTM B-88). No embossed markings allowed.

Selection Guide for Instrumentation Fittings & Tubing

CARBON STEEL TUBING - TABLE 3													
Maximum Allowable Working Pressure (PSIG)													
Tube O.D. Size (in.)	Wall Thickness of Tube (Inches)												
	.028	.035	.049	.065	.083	.095	.109	.120	.134	.148	.165	.180	.220
1/8	8100	10500											
3/16	5150	6700	9900										
1/4	3750	4850	7100	9900									
5/16		3800	5500	7600									
3/8		3100	4500	6200									
1/2		2300	3300	4500	5950								
5/8		1800	2600	3500	4600	5350							
3/4			2150	2900	3750	4375	5100						
7/8			1800	2450	3200	3700	4300						
1			1550	2100	2750	3200	3700	4125					
1-1/4				1650	2150	2500	2900	3200	3600	4050	4600	5000	
1-1/2					1800	2000	2400	2600	3000	3300	3700	4100	5100
2						1500	1700	1900	2200	2400	2700	3000	3700

Calculation Basis: Annealed, seamless carbon steel tubing ASTM A-179 or equivalent. System temperatures between -20°F and +100°F with allowable stress of 15,700 psi. Ultimate tensile strength of 47,500 psi. Safety factor of 4.

Reference: ANSI B 31.3 Code. (For more specific working pressure information regarding a particular tubing, consult with the actual manufacturer of the tubing.)

Suggested Tube Ordering Information: Specify the outside diameter and wall thickness of annealed, seamless carbon steel tubing of ASTM A-179 or equivalent specification. Also specify high quality tubing to be free of scratches, and suited for bending with material hardness not to exceed Rb 72.

MONEL [®] ALLOY 400 TUBING - TABLE 4								
Maximum Allowable Working Pressure (PSIG)								
Tube O.D. Size (in.)	Wall Thickness of Tube (Inches)							
	.028	.035	.049	.065	.083	.095	.109	.120
1/8	8000	10450						
1/4	3750	4800	7000	9800				
3/8		3100	4450	6150				
1/2		2300	3300	4450				
3/4			2250	3050	4000	4600		
1				2250	2900	3400	3900	4350

Calculation Basis: Annealed, seamless Monel Alloy 400 tubing ASTM B-165 or equivalent. System temperatures between -20°F and 100°F with allowable stress of 18,700 psi. Ultimate tensile strength of 70,000 psi. Safety factor of 4. Table values are per the ANSI/ASME B 31.3 Code for temperatures from -325°F to only +100°F. Monel derates fast at elevated temperatures. (For more specific working pressure information regarding a particular tubing, consult with the actual manufacturer of the tubing.)

Suggested Tube Ordering Information: Specify the outside diameter and wall thickness of annealed, seamless Monel Alloy 400 tubing of ASTM B-165 or equivalent specification. Also specify high quality tubing to be free of scratches, and suited for bending with material hardness not to exceed Rb 75.

Selection Guide for Instrumentation Fittings & Tubing

STRESS FACTORS FOR DETERMINING TUBING PRESSURE RATINGS AT ELEVATED TEMPERATURES - TABLE 5						
TEMPERATURE STRESS FACTORS						
Temperature		Stainless Steel		Carbon Steel	Copper	Monel® 400
°F	°C	304SS	316SS			
100	38	1.00	1.00	1.00	1.00	1.00
200	93	1.00	1.00	.96	.80	.88
300	149	1.00	1.00	.90	.78	.82
400	204	.94	.97	.86	.50	.79
500	260	.88	.90	.82	n/a	.79
600	316	.82	.85	.77	n/a	.79
700	371	.80	.82	.73	n/a	.79
800	427	.76*	.80*	.59	n/a	.76
900	482	.73*	.78*	.41	n/a	.43
1000	538	.69*	.73*	.16	n/a	n/a
1200	649	.30*	.37*	n/a	n/a	n/a

* The precipitation of chromium carbides potentially resulting in intergranular corrosion may occur when exposed to operating temperatures above 800°F. Consult the factory for further information.

Instructions: To determine maximum allowable working pressures for tubing at elevated temperatures, multiply the applicable tube's maximum allowable working pressure from Table 1-4 by the corresponding temperature stress factor from Table 5.

SSP NPT PIPE END PRESSURE RATINGS, ANSI/ASME B 31.3 - TABLE 6													
NPT/ISO Pipe Size	Size	316 STAINLESS STEEL				BRASS				CARBON STEEL			
		Male		Female		Male		Female		Male		Female	
		psig	bar	psig	bar	psig	bar	psig	bar	psig	bar	psig	bar
1/16"	1	11050	760	6750	460	5550	380	3350	230	11050	760	6750	460
1/8"	2	10050	690	6550	450	5050	350	3250	220	10050	690	6550	450
1/4"	4	8050	550	6650	460	4050	280	3350	230	8050	550	6650	460
3/8"	6	7850	540	5350	370	3950	270	2650	180	7850	540	5350	370
1/2"	8	7750	530	4950	340	3850	260	2450	170	7750	530	4950	340
3/4"	12	7350	510	4650	320	3650	250	2350	160	7350	510	4650	320
1"	16	5350	370	4450	310	2650	180	2250	150	5350	370	4450	310
1-1/4"	20	6000	410	5000	350	3000	200	2500	170	6000	410	5000	350
1-1/2"	24	5000	340	4600	310	2500	170	2300	150	5000	340	4600	310
2"	32	3900	270	3900	270	1900	300	1900	130	3900	270	3900	270

Reference: bar = .0690 X psig To obtain ANSI/ASME B 31.1 values, multiply ANSI/ASME B 31.3 values by .94

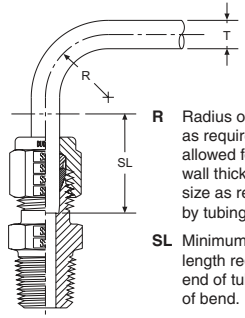

FIGURE A

R Radius of tubing bend as required or minimum allowed for specified wall thickness and tube size as recommended by tubing manufacturer.

SL Minimum straight tube length required from end of tube to beginning of bend.

T Tube outside diameter.

INSTALLING TUBE FITTINGS NEAR TUBE BENDS

When installing fittings near tube bends, it is important to **bend tubing prior to installing tube fittings** and there must be a sufficient straight length (SL) of tubing to allow the tube to be bottomed in the fitting. Note Table 7 for details.

TABLE 7

T = Tube O.D.(in.)	1/16	1/8	3/16	1/4	5/16	3/8	1/2	5/8	3/4	7/8	1	1-1/4	1-1/2	2
*SL=Minimum Straight Length of Tube (in.)	1/2	3/4	3/4	13/16	7/8	15/16	1-3/16	1-1/4	1-1/4	1-5/16	1-9/16	2	2-13/32	3-1/4
R	Radius of tube bend as recommended by bender manufacturer													

* Consult the factory on an application by application basis for variance.



WARNING

IMPROPER SELECTION OR IMPROPER USE OF THE PRODUCTS DESCRIBED HEREIN OR RELATED ITEMS CAN CAUSE PERSONAL INJURY AND PROPERTY DAMAGE.

It is the sole responsibility of the system designers and users to properly select and use products for their specific applications. This document has been printed for users with technical expertise as a reference for further investigation to determine specific product needs relative to design requirements.

Safety Information / Warranty

Safety

To help ensure the safe and reliable performance of tube fitting products, complete system design must be considered prior to the installation of the tubing and tube fittings. Determining the design compatibility of materials, media, flows, temperatures and pressures; as well as implementing proper installation, operation and maintenance of the system are the responsibilities of the systems' owners, designers and users.

SSP Safety Reminders

All SSP products are designed and manufactured with safety in mind. The following is a limited list of general safety tips as reminders of good safety practices:

- Do not install, tighten or loosen a tube fitting while the system is under pressure.
- Do not loosen a tube fitting, nut or plug to relieve or bleed system pressure.
- Always use a back-up wrench to hold the tube fitting body steady when tightening or loosening tube fitting nuts.
- There is no need to disassemble a new tube fitting prior to use.
- Use proper thread lubricants and sealants on tapered pipe threads.
- Very soft, pliable plastic tubing requires a tube insert.
- Tube fitting and tubing material should be similar (stainless steel fittings on stainless steel tubing, brass fittings on copper tubing, etc.) with the tubing material being fully annealed. For more specific information, refer to the Selection Guide for Instrumentation Fittings and Tubing on pages 50 - 53.
- Do not weld tube fittings that are assembled. Prior to welding, remove the nut and ferrules and protect the seat and thread area of the tube fitting by covering with a plug or another nut. (See page 30 for more information.)

Unilok[®] Tube Fittings

LIFETIME LIMITED WARRANTY

SSP guarantees all Unilok tube fittings and Unilok tube fitting components to be free from defects in materials and workmanship. Additionally, SSP guarantees Unilok product performance to the published catalog specifications when properly installed according to the catalog selection and installation instructions. To initiate a warranty claim, suspected defective product must be returned to SSP with the nature of potential defect documented for factory evaluation. Any product with a determined defect in material or workmanship will be replaced with equivalent product at no charge.

This warranty comprises the sole and entire warranty pertaining to items provided hereunder. There is no other warranty, guarantee, express or implied representation of any kind whatsoever. All other warranties including, but not limited to, merchantability and fitness for purpose, whether express, implied, or arising by operation of law, course of dealing, or trade usage are hereby disclaimed. There are no warranties which extend beyond the description on the face hereof; and this warranty does not apply in cases of abuse, mishandling, or normal use depreciation. In no event, whether alleged to arise from breach of contract, express or implied warranty, by operation of law, negligence or otherwise, will SSP be liable for any incidental, consequential, lost property, or other special damages of any kind whatsoever. The exclusive, only remedy under this warranty is the replacement of determined defective parts as set forth above.

Also from SSP Instrumentation

In addition to Unilok Tube Fittings, SSP Instrumentation also offers Duolok and Griplok Instrumentation Tube Fittings; TruFit Pipe, Weld, Hose and Adapter Fittings; and FloLok Valves. Contact your SSP Instrumentation Distributor for more information.

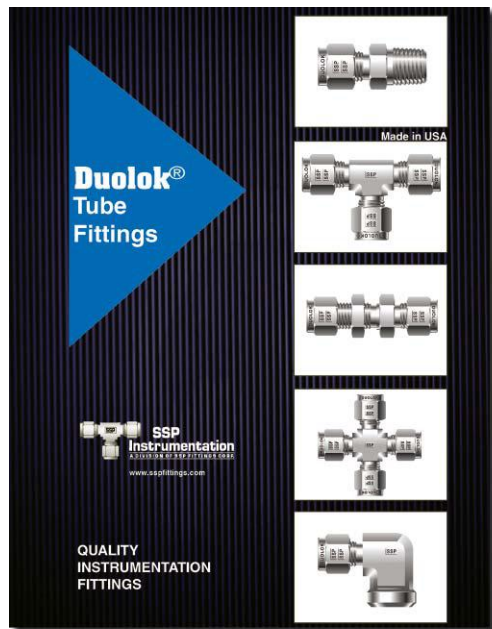

Duolok® Tube Fittings

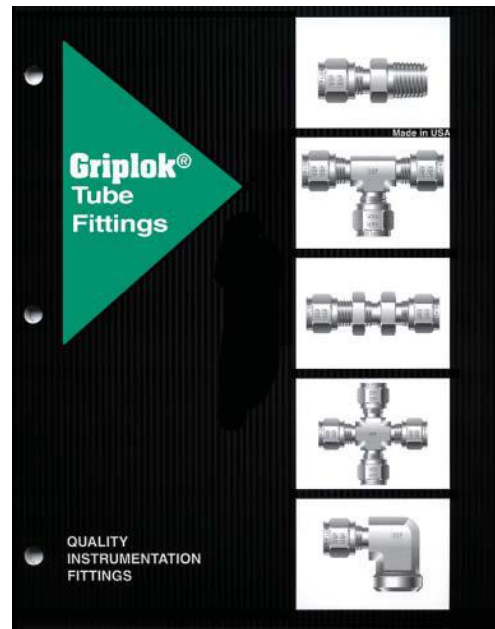

Griplok® Tube Fittings

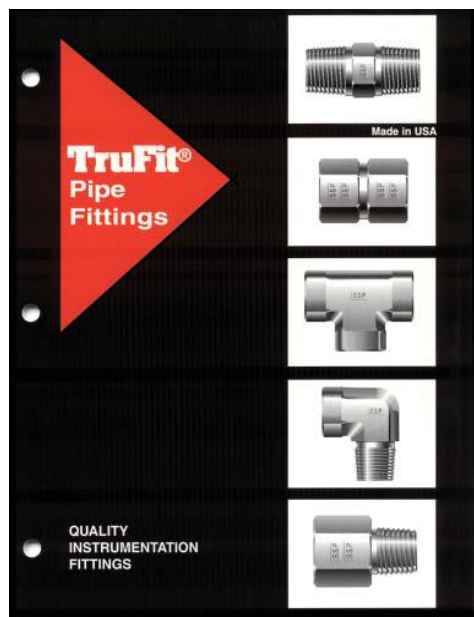

TruFit® Pipe Fittings

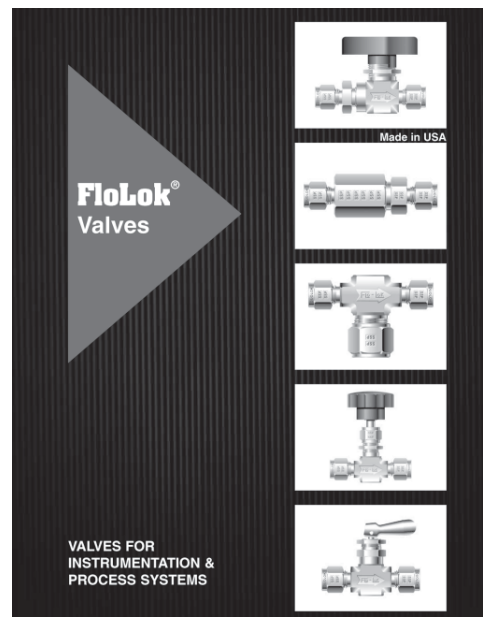

FloLok® Valves

Unilok[®] Tube Fittings

AUTHORIZED DISTRIBUTOR



SSP
Instrumentation
A DIVISION OF SSP FITTINGS CORP.

8250 Boyle Parkway
Twinsburg, Ohio 44087-2200
Telephone: (330) 425-3960
Fax: (330) 425-8116
www.sspfittings.com



Made in the USA

