

swagelok.com

An Installer's
Pocket Guide
for Swagelok®

Tube Fittings



Swagelok®



Table of Contents

Intermix/Interchange10

Metric Swagelok Tube Fittings10

Installation Instructions

■ Safety Precautions	11
■ Up to 1 in./25 mm Swagelok Tube Fittings	12
■ Over 1 in./25 mm Swagelok Tube Fittings	13
■ Gaugeability	13
■ Reassembly	14
■ O-Seal Male Connectors	15
■ Caps and Plugs	15
■ Pipe Thread Fittings	15
■ Port Connectors	16
■ Positionable Elbows and Tees	18
■ Tube Adapters	19
■ Weld Fittings	20
■ Depth Marking Tool	20
■ Non-Gaugable Preswaging Tool	21
■ Tools Required for Gaugeable Preswaging Tool Instructions	22
■ Gaugeable Preswaging Tool Instructions	23
■ Gaugeable Preswaging Tool, Tube Fitting Installation	24
■ Gaugeability	25

Hydraulic Swaging Units

■ Multihead (MHSU)	26
■ Air-Actuated (AHSU)	27

Tubing

■ Installation	28
■ Selection	29
■ Gas Service	29
■ Fractional Carbon Steel Tubing	30
■ Metric Carbon Steel Tubing	32
■ Fractional Stainless Steel Seamless Tubing	34
■ Metric Stainless Steel Seamless Tubing	36
■ Fractional Copper Tubing	38

Ordering Information 39

Straight Fittings

Unions



■ Union	40
■ Reducing Union	42
■ Bulkhead Union	44
■ Bulkhead Reducing Union	44

Male Connectors



■ NPT	45
■ ISO/BSP Tapered Thread (RT)	47
■ ISO/BSP Parallel Thread (RS)	49
■ ISO/BSP Parallel Thread (RP)	51
■ Bulkhead NPT	53
■ SAE/MS Straight Thread (ST)	54
■ O-Seal (SAE/MS Straight Thread)	55
■ O-Seal (NPT)	55
■ AN Fitting	56
■ AN Bulkhead Fitting	56
■ 10-32 Thread	57
■ M5 × 0.8 Thread	57
■ Metric Thread (RS)	57

Weld Connectors



■ Tube Socket Weld	58
■ Male Pipe Weld	58

Straight Fittings

Female Connectors



- NPT 60
- ISO/BSP Tapered Thread (RT). 62
- ISO/BSP Parallel Thread (RJ) 63
- ISO/BSP Parallel Thread (RP) 63
- ISO/BSP Parallel Thread (RG, Gauge) 64
- Bulkhead NPT 65

Reducers



- Reducer 66
- Long Reducer. 69
- Bulkhead Reducer 69

Port Connectors



- Port Connector. 70
- Reducing Port Connector 71

Caps and Plugs



- Cap 72
- Plug. 73
- Vent Protectors. 74

90° Elbows

Unions



- Union. 75

Male



- NPT 76
- ISO/BSP Tapered Thread (RT). 78
- Reducing. 80
- Positionable, SAE/MS Straight Thread (ST). 80
- Positionable, ISO/BSP Parallel Thread (PR) 81

Weld



- Tube Socket Weld 82
- Male Pipe Weld 82

Female



- NPT 83

45° Elbows

Male



- NPT 84
- Positionable, SAE/MS
Straight Thread (ST). 84

Tees



- Union. 85
- Reducing Union 86

Male



- Branch, NPT (TTM) 88
- Run, NPT (TMT) 89
- Positionable Branch, SAE/MS
Straight Thread (TTS). 90
- Positionable Run, SAE/MS
Straight Thread (TST). 90
- Positionable Branch, ISO/BSP
Parallel Thread (TTR). 91
- Positionable Run, ISO/BSP
Parallel Thread (TRT). 92

Female



- Run, NPT (TFT). 93
- Branch, NPT (TTF) 94



- Cross, Union. 95



- Sanitary Flange Fittings. 96

Tube Adapters

Male



- NPT 97
- ISO/BSP Tapered Thread (RT) 98
- ISO/BSP Parallel Thread (RS) 99
- ISO/BSP Parallel Thread (RP) 100
- SAE/MS Straight Thread (ST) 100
- O-Seal (SAE/MS
Straight Thread) 101
- AN Thread 101
- Pipe Weld 101

Female



- NPT 102
- ISO/BSP Tapered Thread (RT) 103
- ISO/BSP Parallel Thread (RP) 103
- ISO/BSP Parallel Thread
(RG, Gauge) 104
- ISO/BSP Parallel Thread (RJ) 105
- AN Thread 105

Part Numbering

- Tube Fitting Part Numbers 106
- Tube Adapter Part Numbers 109

Replacement Parts

Nuts



- Female 111
- Knurled Female 112
- Male 112

Ferrules



- Front 113
- Back 114
- Nut-Ferrule Sets, Packages. 115
- Ferrule Sets, Ferrule-Paks™ 116

ISO/BSP Parallel Gaskets



- Steel and Stainless Steel (RS Fitting) 117
- Copper (RP and RS Fitting) 118
- Copper and Nickel (RG, Gauge Fitting) 118
- PTFE (RJ Fitting) 118

O-Rings



- Buna N (O-Seal Straight Threads) 119
- Buna N (O-Seal Pipe Threads) ... 119
- Fluorocarbon FKM (Positionable Fittings, ISO/BSP Parallel Threads) 120
- Fluorocarbon FKM (SAE/MS Straight Threads) 120

Tools and Accessories



- Bulkhead Retainers 121



- Gap Inspection Gauges 122

- Depth Marking Tools 124



- Preswaging Tools 125



- Inserts for Soft Plastic Tubing 126

About Swagelok

Swagelok is a leading developer and provider of fluid system products, assemblies, and services for the oil and gas, chemical and petrochemical, semiconductor, transportation, and power industries. With millions of our products in use around the world and a growing offering of services, Swagelok has long been synonymous with exceptional quality and reliability.

Our expertise in materials science and product design, combined with an extensive global sales and service network, enables us to be a highly valued resource for our customers, even in the most demanding applications, for experience, insight, and support. We are committed to fostering a culture that promotes our core values of innovation, continuous improvement, respect, quality, customer focus, and integrity.

We are pleased to provide this global edition of the *An Installer's Pocket Guide for Swagelok Tube Fittings*. This is up to date at the time of printing, with its revision number shown on the back page. Subsequent revisions will supersede the printed version and will be posted on the Swagelok website and in the Swagelok electronic Desktop Technical Reference (eDTR) tool.

Visit swagelok.com to locate your Swagelok representative and obtain information on features, technical information and product references, and the variety of services available only through authorized Swagelok sales and service centers.

Markets Served

Oil and gas; chemical/petrochemical; semiconductor; transportation; power; food, beverage, and dairy; biopharmaceutical; pulp and paper; analytical instrumentation; process instrumentation

Intermix/Interchange with Other Manufacturers' Components

This practice can be dangerous. Leak-tight seals that will withstand high pressure, vibration, vacuum, and temperature changes depend on close tolerances and consistent, exacting quality control in conjunction with good design principles. The critical interaction of precision parts is essential for reliability and safety.

Components of other manufacturers may look like Swagelok tube fitting components—but they cannot be manufactured in accordance with Swagelok engineering standards, nor do they benefit from innovations in design and manufacture defined by more than 36 active Swagelok tube fitting patents issued since 1989.

Metric Swagelok Tube Fittings

Metric tube fittings have a stepped shoulder on the body hex.

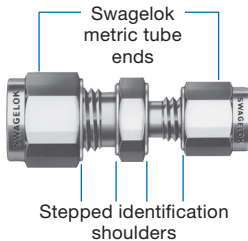
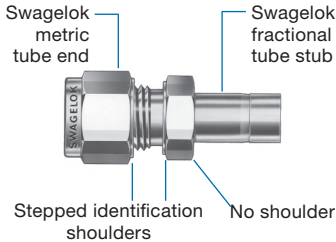

Shaped fittings, such as elbows, crosses, and tees, are stamped MM for metric tubing and have no step on the forging.

Installation Instructions

Swagelok tube fittings 1 in./25 mm and smaller can be installed quickly, easily, and reliably with simple hand tools.

Over 1 in./25 mm sizes require use of a hydraulic swaging unit to swage the ferrules onto the tubing.

Safety Precautions

- Do not bleed system by loosening fitting nut or fitting plug.
- Do not assemble and tighten fittings when system is pressurized.
- Make sure that the tubing rests firmly on the shoulder of the tube fitting body before tightening the nut.
- Use the correct Swagelok gap inspection gauge to ensure sufficient pull-up upon initial installation.
- Always use proper thread sealants on tapered pipe threads.
- Do not mix materials or fitting components from various manufacturers—tubing, ferrules, nuts, and fitting bodies.
- Never turn fitting body. Instead, hold fitting body and turn nut.
- Avoid unnecessary disassembly of unused fittings.
- Use only long reducers in female Swagelok end connections.

See the instructions starting on the next page for installation of Swagelok tube fittings, O-seal male connectors, caps and plugs, port connectors, tube adapters, positionable elbows and tees, weld fittings, depth marking tool, and preswaging tool.

Swagelok Tube Fittings

Up to 1 in./25 mm

Safe practices and proper installation are imperative to the performance of the Swagelok tube fitting, especially in critical applications.

For 5/8, 3/4, 7/8 and 1 in.; 16, 18, 20, 22 and 25 mm tube fittings, in all materials except for aluminum and brass, it is a best practice to preswage the ferrules onto the tube adapter using a Swagelok multihead hydraulic swaging unit (MHSU) to lower installation time and increase ease of installation (see Multihead Hydraulic Swaging Unit (MHSU), Setup and Operating Instructions, [MS-12-37](#)).

Fully insert the tube into the fitting and against the shoulder; rotate the nut finger-tight.

High-pressure applications and high safety-factor systems:

Further tighten the nut until the tube will not turn by hand or move axially in the fitting.

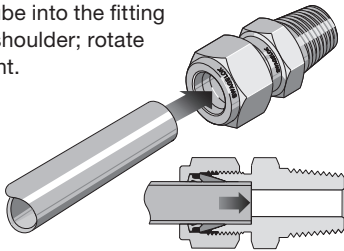

Mark the nut at the 6 o'clock position.

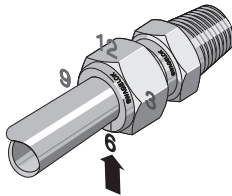

While holding the fitting body steady, tighten the nut one and one-quarter turns to the 9 o'clock position.

For 1/16, 1/8, and 3/16 in.; 2, 3, and 4 mm tube fittings, tighten the nut three-quarters turn to the 3 o'clock position.

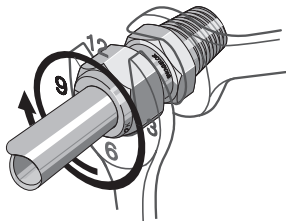

Swagelok Tube Fittings

Over 1 in./25 mm

1. Preswage the ferrules onto the tube using a Swagelok multihead hydraulic swaging unit (MHSU).
2. Apply the lubricant packaged with the fitting lightly to the body threads and the rear surface of the back ferrule. For gas service also apply lightly to the front angled surface of the front ferrule.
3. Insert the tube with preswaged ferrules into the fitting until the front ferrule seats against the fitting body; rotate the nut finger-tight.
4. Mark the nut at the 6 o'clock position.
5. While holding the fitting body steady, tighten the nut one-half turn to the 12 o'clock position.

Use the Swagelok MHSU gap inspection gauge to ensure that the fitting has been tightened sufficiently.

Gaugeability

On initial installation, the Swagelok gap inspection gauge assures the installer or inspector that a fitting has been sufficiently tightened.

Position the Swagelok gap inspection gauge next to the gap between the nut and body.

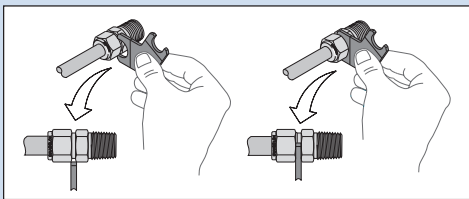

If the gauge **will not** enter the gap, the fitting is sufficiently tightened.

If the gauge **will** enter the gap, additional tightening is required.

Warning

Always depressurize a system before adjusting the tightness of a tube fitting connection.

Swagelok Tube Fittings

Reassembly—All Sizes

You may disassemble and reassemble Swagelok tube fittings many times.

⚠ Always depressurize the system before disassembling a Swagelok tube fitting.

Prior to disassembly, mark the tube at the back of the nut; mark a line along the nut and fitting body flats.

Use these marks to ensure that you return the nut to the previously pulled-up position.

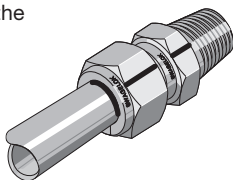

Insert the tube with preswaged ferrules into the fitting until the front ferrule seats against the fitting body.

Over 1 in./25 mm

sizes: *If needed, reapply lubricant lightly to the body threads and the rear surface of the back ferrule.*

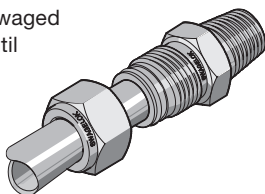

While holding the fitting body steady, rotate the nut with a wrench to the previously pulled-up position, as indicated by the marks on the tube and flats. At this point, you will feel a significant increase in resistance. Tighten the nut slightly.

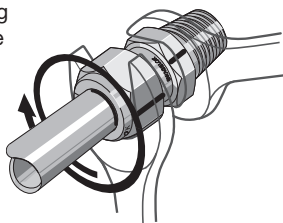

⚠ Caution
Do not use the Swagelok gap inspection gauge with reassembled fittings.

O-Seal Male Connectors

1. Turn the O-seal connector into the female end until it is finger-tight.
2. Tighten the O-seal connector until it makes metal-to-metal contact with the face of the female end.
3. Tighten slightly with a wrench.

O-rings are coated with a thin film of silicone-based lubricant. Removal of factory-applied lubricants may alter performance.

Caps and Plugs

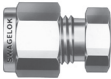

Caps

See Swagelok tube fitting installation and reassembly, page 15 and 14



Plugs

While holding fitting body steady, tighten the plug one-quarter turn from the finger-tight position.

For 1/16, 1/8, and 3/16 in.; 2, 3, and 4 mm tube fittings, tighten the plug one-eighth turn.

For over 1 in. and over 25 mm tube fittings, tighten the plug one-quarter turn.

⚠ Do not use the Swagelok gap inspection gauge with plug assemblies.

Reassembly

You may disassemble and reassemble Swagelok plugs many times. Make subsequent connections by slightly tightening with a wrench after snugging the nut by hand.

Pipe Thread Fittings

A thread sealant should always be used when assembling tapered threads. SWAK™ anaerobic pipe thread sealant, PTFE-Free pipe thread sealant, and Swagelok PTFE Tape are available. For more information, see the Swagelok *Leak Detectors, Lubricants, and Sealants* catalog, [MS-01-91](#).

Port Connectors

Connect the machined ferrule end **before** connecting the tube adapter end.

Machined Ferrule End

1. Remove the nut and ferrules from the Swagelok end connection. Discard the ferrules.

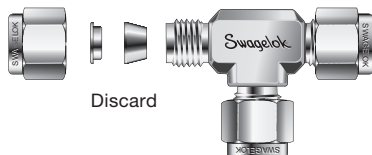

2. Slip the nut over the machined ferrule end of the port connector.

Over 1 in./25 mm sizes:

The nut is preassembled on the port connector.

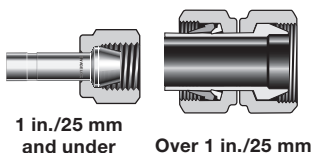

3. Insert the port connector into the end connection and finger-tighten the nut.

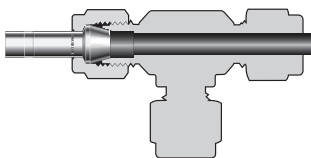

4. While holding fitting body steady, tighten the nut one-quarter turn.
For 1/16, 1/8, and 3/16 in.; 2, 3, and 4 mm tube fittings, tighten the nut one-eighth turn.

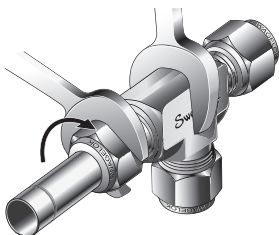

⚠ Do not use the Swagelok gap inspection gauge with machined ferrule ends.

Port Connectors

Reassembly

You may disassemble and reassemble Swagelok port connectors many times. Make subsequent connections by slightly tightening with a wrench after snugging the nut by hand.

Tube Adapter End

5. Insert the tube adapter until it rests firmly on the shoulder of the Swagelok tube fitting body. Finger-tighten the nut.

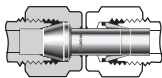

Over 1 in./25 mm sizes: Remove and discard the nut and ferrules from the end connection, then insert the tube adapter.

6. Mark the nut at the 6 o'clock position. While holding fitting body steady, tighten the nut one and one-quarter turns to the 9 o'clock position.

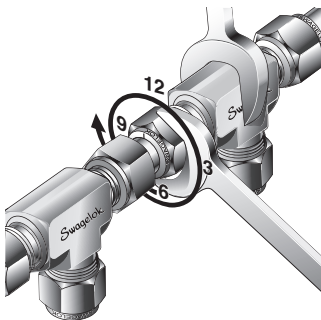

For 1/16, 1/8, and 3/16 in.; 2, 3, and 4 mm tube fittings, tighten the nut three-quarters turn to the 3 o'clock position.

For preswaged over 1 in./25 mm and over tube fittings, tighten the nut one-half turn to the 12 o'clock position.

⚠ Do not use the Swagelok gap inspection gauge with preswaged tube adapter connections over 1 in./25 mm.

Reassembly

See Swagelok tube fitting reassembly, page 14.

Positionable Elbows and Tees

1. Turn the positionable end into the female fitting until the metal backup washer contacts the face of the fitting.
2. Turn the positionable end out of the female fitting (not more than one turn) until the Swagelok tube fitting end is positioned properly.
3. While holding fitting body steady, tighten the lock nut until the metal backup washer contacts the face of the fitting.

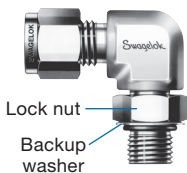

Tube Adapters

Up to 1 in./25 mm

Safe practices and proper installation are imperative to the performance of the Swagelok tube fitting, especially in critical applications.

For 5/8, 3/4, 7/8 and 1 in.; 16, 18, 20, 22 and 25 mm tube fittings, in all materials except for aluminum and brass, it is a best practice to preswage the ferrules onto the tube adapter using a Swagelok multihead hydraulic swaging unit (MHSU) to lower installation time and increase ease of installation (see Multihead Hydraulic Swaging Unit (MHSU), Setup and Operating Instructions, [MS-12-37](#)).

1. Install the end opposite the tube adapter end.

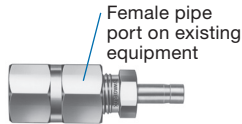

2. Insert the tube adapter into the Swagelok tube fitting. Make sure that the tube adapter rests firmly on the shoulder of the tube fitting body and that the nut is finger-tight.



3. Mark the nut at the 6 o'clock position.
4. While holding fitting body steady, tighten the nut one and one-quarter turns to the 9 o'clock position.

For 1/16, 1/8, and 3/16 in.; 2, 3, and 4 mm tube fittings, tighten the nut three-quarters turn to the 3 o'clock position.

Over 1 in./25 mm

Swagelok tube adapters over 1 in./25 mm are furnished with nuts and preswaged ferrules.

To assemble, follow steps 2 through 5 of the Swagelok tube fittings over 1 in./25 mm assembly instructions, page 13.

- ⚠ Do not use the Swagelok gap inspection gauge with preswaged tube adapter connections over 1 in./25 mm.**

Tube Adapters

Reassembly

See Swagelok tube fitting reassembly, page 14.

Weld Fittings

Welding Precautions for Swagelok Tube Fittings with Weld End Connections

1. Remove the nut and ferrules.
2. Turn a Swagelok tube fitting plug or another nut onto the fitting so that it is finger-tight. This protects the threads and sealing components.
3. Provide a suitable heat sink to dissipate the heat.
4. Tack weld at four positions 90° apart to hold the fitting in place and to ensure alignment and concentricity of the components.
5. Complete the weld.
6. Remove the plug or nut and replace the nut and ferrules.



Caution

When welding carbon steel fittings, the heat often removes the protective oil from the threads. It is important to apply another lubricant, such as Goop™ thread lubricant.

Depth Marking Tool

1. Insert cleanly cut, fully deburred tube into the depth marking tool (DMT) until the tube is against the shoulder of the tool. Using a pen or pencil, mark the tube at the top of the DMT.
2. Remove the tube from the DMT and insert it into the Swagelok fitting until it is against the shoulder of the fitting body. Rotate the nut finger-tight. If any portion of the mark on the tube can be seen above the fitting nut, the tube is not fully inserted into the fitting.
3. While holding the fitting body steady, follow Swagelok tube fitting installation instructions, page 12.



Non-Gaugable Preswaging Tool

Note: These instructions apply only to non-gaugable preswaging tools. Tool will not have a colored band and the ordering number does not contain GA.

1. Install the Swagelok nut and ferrules onto the preswaging tool.
2. Insert the tube into the preswaging tool.
3. Make sure that the tube rests firmly on the shoulder of the preswaging tool body and that the nut is finger-tight.
4. Mark the nut at the 6 o'clock position.
5. While holding the preswaging tool steady, tighten the nut one and one-quarter turns to the 9 o'clock position.

For 1/16, 1/8, and 3/16 in.; 2, 3, and 4 mm tube fittings, tighten the nut only three-quarters turn to the 3 o'clock position.

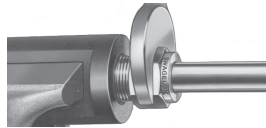

6. Loosen the nut.
7. Remove the tube with preswaged ferrules from the preswaging tool. If the tube sticks in the preswaging tool, remove the tube by gently rocking it back and forth. Do not turn the tube.



8. Insert the tube with preswaged ferrules into the fitting body until the front ferrule seats against the fitting body.
9. While holding the fitting body steady, rotate the nut with a wrench to the previously pulled-up position; at this point, you will feel a significant increase in resistance.
10. Tighten the nut slightly.

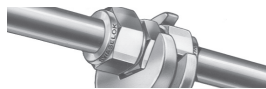

⚠ Do not use the Swagelok gap inspection gauge with fittings that were assembled with a non-gaugable preswaging tool.

Tools Required for Gaugeable Preswaging Tool Instructions

1. Gaugeable preswage tool will have a colored band. Gaugeable tools are available in sizes 1/4, 3/8, 1/2, 5/8 in., and 6, 8, 10, 12, 16 mm.



2. Body wrench and nut wrench.



3. Standard gap gauge for standard assembly.



4. Severe-service gap gauge for high-pressure applications or high safety-factor systems.



Gaugeable Preswaging Tool Instructions

1. Install the Swagelok nut and ferrules onto the preswaging tool.

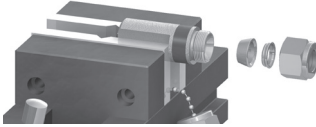

2. Insert the tube into the preswaging tool until it rests firmly on the shoulder of the tool; rotate the nut finger-tight.

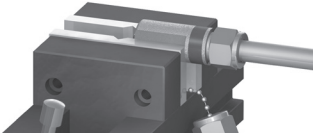

3. While holding the preswaging tool steady, tighten the nut with a wrench until it stops against the collar.

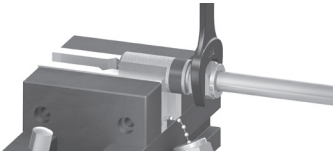

4. Loosen the nut and remove the tube with preswaged ferrules from the preswaging tool. If the tube sticks, gently rock it back and forth. Do not turn the tube.

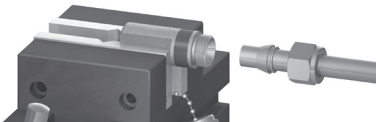

Gaugeable Preswaging Tool, Tube Fitting Installation

1. Insert the tube with preswaged ferrules into the fitting until the front ferrule seats against the fitting body; rotate the nut finger-tight.

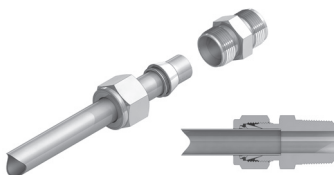

2. Mark the nut at the 6 o'clock position.

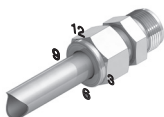

3. While holding the fitting body steady, tighten the nut one-half turn to the 12 o'clock position.

Note: If assembling fittings for high-pressure applications or high safety-factor systems, tighten one hex flat further than one-half turn.



Gaugeability

On initial installation, the Swagelok gap inspection gauge assures the installer or inspector that a fitting has been sufficiently tightened.

If the nut was tightened additionally during installation (step 3 on previous page), use Fig. 1 for gauging, otherwise use Fig. 2.

Position the Swagelok gap inspection gauge next to the gap between the nut and body.

- If the gauge will not enter the gap, the fitting is sufficiently tightened.
- If the gauge will enter the gap, additional tightening is required.

Fig. 1

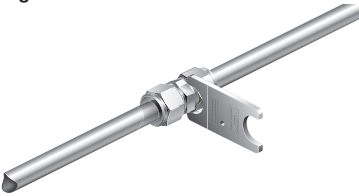
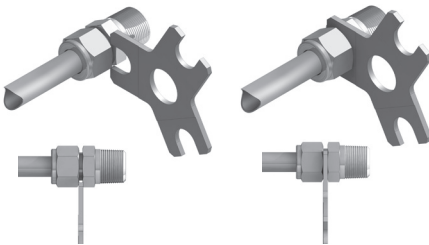

Fig. 2



Hydraulic Swaging Units

Swagelok hydraulic swaging units preswage Swagelok ferrules onto tubing prior to assembly and provide Swagelok tube fitting connections that are 100 % gaugeable upon initial installation. Multihead hydraulic and air-actuated hydraulic swaging units:

- Place no initial strain on fitting body threads or on body seal surfaces
- Are available with interchangeable fractional and metric tooling
- Fit neatly in a rugged plastic carrying case
- Reduce assembly and installation time and operator error

Multihead (MHSU)



- Is available in two unit sizes, with tooling for:
 - 1/2 to 1 in. and 12 to 25 mm tubing and tube adapters
 - 1 to 2 in. and 25 to 50 mm tubing
- **Must** be used to install 1 1/4, 1 1/2, and 2 in. and 28, 30, 32, 38, and 50 mm Swagelok tube fittings
- Is standard with a tube marking feature to indicate when tube is properly bottomed in the unit
- Is available with a support base (as shown)
- Is available with hydraulic hose; support base is required

The MHSU cannot be used for alloy 2507 tubing 1/2 in. and under.

For 5/8 and 3/4 in. alloy 2507 tubing, order the 1 in./25 mm and over unit and alloy 2507 tooling kit and gap inspection gauges.

Hydraulic Swaging Units

Air-Actuated (AHSU)

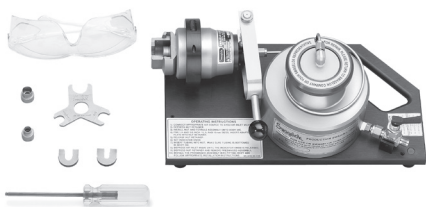

- Requires only one unit with interchangeable tooling to swage 1/4 to 1/2 in. and 6 to 12 mm Swagelok tube fitting ferrule sizes
- Requires no threading of nut on or off the tooling

The AHSU cannot be used for alloy 2507 tubing.
Additional Information, MHSU and AHSU

See the Swagelok *Gaugeable Tube Fittings and Adapters* catalog, [MS-01-140](#). For instructions, see *Multihead Hydraulic Swaging Unit (MHSU) Setup and Operation Instructions*, [MS-12-37](#), and *Air-Actuated Hydraulic Swaging Unit (AHSU) Setup and Operation Instructions*, [MS-12-38](#).

Tubing Installation

Tubing properly selected and handled, when combined with the quality of Swagelok fittings, will give you leak-tight systems. Properly installed on such tubing, Swagelok fittings provide reliable service under a wide variety of fluid applications.

When installing fittings near tube bends, there must be a sufficient straight length of tubing to allow the tube to be bottomed in the Swagelok fitting (see tables below).

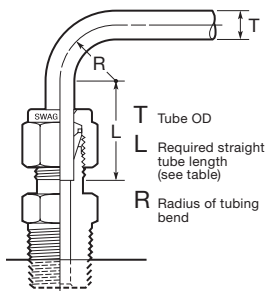

Fractional, in.	
T Tube OD	L ^①
1/16	1/2
1/8	23/32
3/16	3/4
1/4	13/16
5/16	7/8
3/8	15/16
1/2	1 3/16
5/8	1 1/4
3/4	
7/8	1 5/16
1	1 1/2
1 1/4	2
1 1/2	2 13/32
2	3 1/4

① Required straight tube length.

Metric, mm	
T Tube OD	L ^①
3	19
6	21
8	23
10	25
12	31
14	32
15	
16	
18	34
20	
22	34
25	40
28	46
30	50
32	54
38	63
50	80

Tubing Selection

- Metal tubing material should be softer than fitting material. For example, stainless steel tubing should not be used with brass fittings.
- When tubing and fittings are made of the same material, tubing must be fully annealed.
- Always use an insert with extremely soft or pliable plastic tubing.
- Extremes of wall thickness should always be checked against the suggested minimum and maximum wall thickness limitations.
- Surface finish is very important to proper sealing. Tubing with any kind of depression, scratch, raised portion, or other surface defect will be difficult to seal, particularly in gas service.
- Tubing that is oval and will not easily fit through fitting nuts, ferrules, and bodies should never be forced into the fitting.

Gas Service

Gases (air, hydrogen, helium, nitrogen, etc.) have very small molecules that can escape through even the most minute leak path. Some surface defects on the tubing can provide such a leak path. As tube outside diameter (OD) increases, so does the likelihood of a scratch or other surface defect interfering with proper sealing.

The most successful connection for gas service will occur if all installation instructions are carefully followed and the heavier wall thicknesses of tubing on the following tables are selected.

A heavy-wall tube resists ferrule action more than a thin-wall tube, allowing the ferrules to coin out minor surface imperfections. A thin-wall tube offers less resistance to ferrule action during installation, reducing the chance of coining out surface defects, such as scratches. Within the applicable suggested allowable working pressure table, select a tube wall thickness whose working pressure is *outside* of the shaded areas.

Fractional Carbon Steel Tubing

Allowable working pressures are calculated from an S value of 15 700 psi (108.2 MPa) for ASTM A179 tubing at -20 to 100°F (-28 to 37°C), as listed in ASME B31.3. For working pressure in accordance with ASME B31.1, multiply by 0.85.

Suggested Ordering Information

High-quality, soft annealed seamless carbon steel hydraulic tubing, ASTM A179 or equivalent. Hardness not to exceed 72 HRB or 130 HV. Tubing to be free of scratches, suitable for bending and flaring.

Tube OD in.	Carbon Steel Tube Wall Thickness, in.												Swagelok Fitting Series	
	0.028	0.035	0.049	0.065	0.083	0.095	0.109	0.120	0.134	0.148	0.165	0.180		0.220
	Note: For gas service, select a tube wall thickness outside of the shaded area. (See Gas Service, page 29.)													
1/8	8000	10 200												200
3/16	5100	6 600	9600											300
1/4	3700	4 800	7000	9600										400
5/16		3 700	5500	7500										500
3/8		3 100	4500	6200										600
1/2		2 300	3200	4500	5900									810
5/8		1 800	2600	3500	4600	5300								1010
3/4			2100	2900	3700	4300	5100							1210
7/8			1800	2400	3200	3700	4300							1410
1			1500	2100	2700	3200	3700	4100						1610
1 1/4				1600	2100	2500	2900	3200	3600	4000	4600	5000		2000
1 1/2					1800	2000	2400	2600	3000	3300	3700	4100	5100	2400
2						1500	1700	1900	2200	2400	2700	3000	3700	3200

Installation

Straight Fittings

Elbows and Tees

Adapters

Parts

Accessories

Metric Carbon Steel Tubing

Allowable working pressures are based on equations from ASME B31.3 for DIN 2391 tubing, using a stress value of 113 MPa (16 300 psi) and tensile strength of 340 MPa (49 300 psi).

Suggested Ordering Information

High-quality, soft annealed carbon steel tubing, DIN 2391 or equivalent. Hardness not to exceed 72 HRB or 130 HV. Tubing to be free of scratches, suitable for bending or flaring.

Tube OD mm	Carbon Steel Tube Wall Thickness, mm															Swagelok Fitting Series	
	0.8	1.0	1.2	1.5	1.8	2.0	2.2	2.5	2.8	3.0	3.5	4.0	4.5				
	Working Pressure, bar Note: For gas service, select a tube wall thickness outside of the shaded area. (See Gas Service, page 29.)																
3	620	790															3M0
6	290	370	460	590													6M0
8		270	330	430													8M0
10		210	260	330													10M0
12		170	210	270	330	380	420										12M0
14		150	180	230	280	320	350										14M0
15		140	170	210	260	290	330										15M0
16		130	160	200	240	270	300	350									16M0
18			140	170	210	240	270	310									18M0
20			120	160	190	210	240	270	310								20M0
22			110	140	170	190	210	250	280								22M0
25			100	120	150	170	180	210	240	260							25M0
28					150	160	190	210	230	270	270						28M0
30					140	150	170	200	210	250	250						30M0
32					130	140	160	180	200	240	240	270					32M0
38						120	130	150	160	200	200	230	260				38M0

Accessories

Parts

Adapters

Elbows and Tees

Straight Fittings

Installation

Fractional Stainless Steel Seamless Tubing

Allowable working pressures are calculated from an S value of 20 000 psi (137.8 MPa) for ASTM A269 tubing at -20 to 100°F (-28 to 37°C), as listed in ASME B31.3 and ASME B31.1, except as noted.

For Welded Tubing

For welded and drawn tubing, a derating factor must be applied for weld integrity:

- for double-welded tubing, multiply pressure rating by 0.85
- for single-welded tubing, multiply pressure rating by 0.80.

Suggested Ordering Information

High-quality, fully annealed (Type 304, 304/304L, 316, 316/316L, 317, 317/317L, 321, 347) (seamless or welded and drawn) stainless steel hydraulic tubing, ASTM A269 or A213, or equivalent.

Hardness not to exceed 90 HRB or 200 HV. Tubing to be free of scratches, suitable for bending and flaring. OD tolerances not to exceed ± 0.003 in. for 1/16 in. OD tubing.

Certain austenitic stainless tubing has an allowable ovality tolerance double the OD tolerance and may not fit into Swagelok precision tube fittings. Dual-certified grades such as 304/304L, 316/316L, and 317/317L meet the minimum chemistry and the mechanical properties of both alloy grades.

Tube OD in.	Stainless Steel Tube Wall Thickness, in.															Swagelok Fitting Series	
	0.010	0.012	0.014	0.016	0.020	0.028	0.035	0.049	0.065	0.083	0.095	0.109	0.120	0.134	0.156		0.188
	Working Pressure, psig Note: For gas service, select a tube wall thickness outside of the shaded area. (See Gas Service, page 29.)																
1/16	5600	6800	8100	9400	12 000												100
1/8					8500	10 900											200
3/16					5400	7000	10 200										300
1/4					4000	5100	7500	10 200 ^①									400
5/16						4000	5800	8000									500
3/8						3300	4800	6500	7500 ^{①②}								600
1/2						2600	3700	5100	6700								810
5/8							2900	4000	5200	6000							1010
3/4							2400	3300	4200	4900	5800						1210
7/8							2000	2800	3600	4200	4800						1410
1								2400	3100	3600	4200	4700					1610
1 1/4									2400	2800	3300	3600	4100	4900			2000
1 1/2										2300	2700	3000	3400	4000	4900		2400
2											2000	2200	2500	2900	3600		3200

① For higher pressures, see the Swagelok *Medium- and High-Pressure Fittings, Tubing, Valves and Accessories* catalog, [MS-02-472](#).

② Rating based on repeated pressure testing of the Swagelok tube fitting with a 4:1 design factor based upon hydraulic fluid leakage.

Accessories

Parts

Adapters

Elbows and Tees

Straight Fittings

Installation

Metric Stainless Steel Seamless Tubing

Allowable working pressures are based on equations from ASME B31.3 and ASME B31.1 for EN ISO 1127 tubing (D4, T4 tolerance for 3 to 12 mm; D4, T3 tolerance 14 to 50 mm), using a stress value of 137.8 MPa (20 000 psi) and tensile strength of 516.4 MPa (74 900 psi), except as noted.

For Welded Tubing

For welded and drawn tubing, a derating factor must be applied for weld integrity:

- for double-welded tubing, multiply pressure rating by 0.85
- for single-welded tubing, multiply pressure rating by 0.80.

Suggested Ordering Information

High-quality, fully annealed (Type 304, 304/304L, 316, 316/316L, 317, 317/317L, 321, 347) stainless steel tubing, EN ISO 1127 or equivalent. Hardness not to exceed 90 HRB or 200 HV. Tubing to be free of scratches, suitable for bending or flaring. OD tolerances not to exceed ± 0.076 mm for 3 mm OD tubing.

Dual-certified grades such as 304/304L, 316/316L, and 317/317L meet the minimum chemistry and the mechanical properties of both alloy grades.

Tube OD mm	Stainless Steel Tube Wall Thickness, mm															Swagelok Fitting Series		
	0.8	1.0	1.2	1.5	1.8	2.0	2.2	2.5	2.8	3.0	3.5	4.0	4.5	5.0				
	Working Pressure, bar Note: For gas service, select a tube wall thickness outside of the shaded area. (See Gas Service, page 29.)																	
3	680																	3M0
6	320	430	550	720														6M0
8		310	390	530														8M0
10		240	310	410	510	580												10M0
12		200	250	330	420	480												12M0
14		160	200	270	340	390	430											14M0
15		150	190	250	310	360	400											15M0
16			180	230	290	330	370	400 ^①										16M0
18			150	210	260	290	330	380										18M0
20			140	180	230	260	290	330	360									20M0
22			120	170	210	240	260	300	340									22M0
25					180	200	230	260	300	320								25M0
28						180	200	230	260	280	330							28M0
30						170	190	210	240	260	310							30M0
32						160	170	200	230	240	290	330						32M0
38							140	170	190	200	240	270	310					38M0
50										150	180	200	230	260				50M0

① Rating based on repeated pressure testing of the Swagelok tube fitting with a 4:1 design factor based upon hydraulic fluid leakage.

Fractional Copper Tubing

Allowable working pressures are calculated from an S value of 6000 psi (41.3 MPa) for ASTM B75 and ASTM B88 tubing at -20 to 100°F (-28 to 37°C), as listed in ASME B31.3 and ASME B31.1.

Suggested Ordering Information

High-quality, soft annealed seamless copper tubing, ASTM B75 or equivalent. Also soft annealed (Temper O) copper water tube, type K or type L to ASTM B88.

Tube OD in.	Copper Tube Wall Thickness, in.										Swagelok Fitting Series	
	0.028	0.030	0.035	0.049	0.065	0.083	0.095	0.109	0.120	0.134		
1/8	2800	3000	3600									200
3/16	1800	1900	2300	3400								300
1/4	1300	1400	1600	2500	3400							400
5/16			1300	1900	2700							500
3/8			1000	1600	2200							600
1/2			800	1100	1600	2100						810
5/8				900	1200	1600	1900					1010
3/4				700	1000	1300	1500	1800				1210
7/8				600	800	1100	1300	1500				1410
1				500	700	900	1100	1300	1500			1610
1 1/8				600	800	1100	1300	1500	1800	2100		1810

Working Pressure, psig
Note: For gas service, select a tube wall thickness outside of the shaded area.
 (See Gas Service, page 29.)

Ordering Numbers

Select a basic ordering number.

Example: **-100-6**

Add a material designator.

Example: **SS-100-6**

Minimum order quantities may apply to certain materials and configurations.

Material	Designator
316 SS	SS
6-moly	6Mo
Aluminum	A
Alloy 400	M
Alloy 600	INC
Alloy 625	625
Alloy 825	825
Alloy 2507	2507
Alloy C-276	HC
Brass	B
Carbon steel	S
PTFE	T
Titanium	TI

Additional Products

- For alloy 2507 super duplex tube fittings, see the Swagelok *Gaugeable Alloy 2507 Super Duplex Tube Fittings* catalog, [MS-01-174](#).
- For alloy 400 tube fittings, see the Swagelok *Gaugeable Alloy 400 Mechanically Attached Pipe and Tube Fittings* catalog, [MS-02-332](#).
- For PFA tube fittings, see the Swagelok *PFA Tube Fittings* catalog, [MS-01-05](#).
- For heavy-wall tube fittings and medium-pressure tube fittings, see the Swagelok *Medium- and High-Pressure Fittings, Tubing, Valves and Accessories* catalog, [MS-02-472](#).

Contact your authorized Swagelok sales and service center about additional sizes and special alloys.

Unions



Union

Tube OD in.	Basic Ordering Number
1/16	-100-6
1/8	-200-6
3/16	-300-6
1/4	-400-6
5/16	-500-6
3/8	-600-6
1/2	-810-6
1/2	-810-6-0030 ^①
5/8	-1010-6
3/4	-1210-6
7/8	-1410-6
1	-1610-6
1 1/8	-1810-6
1 1/4	-2000-6
1 1/2	-2400-6
2	-3200-6

① Bored through.

Tube OD mm	Basic Ordering Number
2	-2M0-6
3	-3M0-6
4	-4M0-6
6	-6M0-6
8	-8M0-6
10	-10M0-6
12	-12M0-6
14	-14M0-6
15	-15M0-6
16	-16M0-6
18	-18M0-6
20	-20M0-6
22	-22M0-6
25	-25M0-6
28	-28M0-6
30	-30M0-6
32	-32M0-6
38	-38M0-6
50	-50M0-6

Unions

Union (Metric to Fractional)



Tube OD		Basic Ordering Number
T, mm	Tx, in.	
2	1/8	-2M0-6-2
	1/4	-2M0-6-4
3	1/8	-3M0-6-2
4	1/8	-4M0-6-2
	1/4	-4M0-6-4
6	1/16	-6M0-6-1
	1/8	-6M0-6-2
	1/4	-6M0-6-4
	5/16	-6M0-6-5
	3/8	-6M0-6-6
8	1/4	-8M0-6-4
	3/8	-8M0-6-6
10	1/8	-10M0-6-2
	1/4	-10M0-6-4
	5/16	-10M0-6-5
	3/8	-10M0-6-6
12	1/4	-12M0-6-4
	5/16	-12M0-6-5
	3/8	-12M0-6-6
	1/2	-12M0-6-8
15	1/2	-15M0-6-8
16	5/8	-16M0-6-10
18	3/4	-18M0-6-12
20	1/2	-20M0-6-8
	1	-20M0-6-16
25	1	-25M0-6-16

Installation

Straight Fittings

Elbows and Tees

Adapters

Parts

Accessories

Unions

Reducing Union

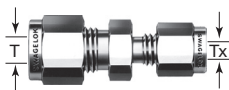

Tube OD, in.		Basic Ordering Number
T	Tx	
1/8	1/16	-200-6-1
3/16	1/16	-300-6-1
	1/8	-300-6-2
1/4	1/16	-400-6-1
	1/8	-400-6-2
	3/16	-400-6-3
5/16	1/8	-500-6-2
	1/4	-500-6-4
3/8	1/16	-600-6-1
	1/8	-600-6-2
	1/4	-600-6-4
	5/16	-600-6-5
1/2	1/8	-810-6-2
	1/4	-810-6-4
	3/8	-810-6-6
5/8	3/8	-1010-6-6
	1/2	-1010-6-8
3/4	1/4	-1210-6-4
	3/8	-1210-6-6
	1/2	-1210-6-8
	5/8	-1210-6-10
1	1/2	-1610-6-8
	3/4	-1610-6-12

Unions

Reducing Union

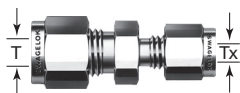

Tube OD, mm		Basic Ordering Number
T	Tx	
3	2	-3M0-6-2M
6	2	-6M0-6-2M
	3	-6M0-6-3M
	4	-6M0-6-4M
8	6	-8M0-6-6M
10	6	-10M0-6-6M
	8	-10M0-6-8M
12	6	-12M0-6-6M
	8	-12M0-6-8M
	10	-12M0-6-10M
16	10	-16M0-6-10M
	12	-16M0-6-12M
18	12	-18M0-6-12M
25	18	-25M0-6-18M
	20	-25M0-6-20M
30	18	-30M0-6-18M
	20	-30M0-6-20M
	25	-30M0-6-25M
32	18	-32M0-6-18M
	20	-32M0-6-20M
	25	-32M0-6-25M
38	20	-38M0-6-20M
	25	-38M0-6-25M
	30	-38M0-6-30M

Installation

Straight Fittings

Elbows and Tees

Adapters

Parts

Accessories

Unions

Installation

Bulkhead Union



Straight Fittings

Tube OD in.	Basic Ordering Number
1/16	-100-61
1/8	-200-61
3/16	-300-61
1/4	-400-61
5/16	-500-61
3/8	-600-61
1/2	-810-61
5/8	-1010-61
3/4	-1210-61
1	-1610-61
1 1/4	-2000-61
1 1/2	-2400-61
2	-3200-61

Elbows and Tees

Tube OD mm	Basic Ordering Number
3	-3M0-61
4	-4M0-61
6	-6M0-61
8	-8M0-61
10	-10M0-61
12	-12M0-61
14	-14M0-61
15	-15M0-61
16	-16M0-61
18	-18M0-61
20	-20M0-61
25	-25M0-61
30	-30M0-61
32	-32M0-61
38	-38M0-61

Adapters

Bulkhead Reducing Union



Parts

Tube OD, in.		Basic Ordering Number
T	Tx	
1/8	1/16	-200-61-1
1/4	1/8	-400-61-2
3/8	1/4	-600-61-4
1/2	1/4	-810-61-4

Accessories

Bulkhead Reducing Union (Metric to Fractional)

Tube OD		Basic Ordering Number
T, mm	Tx, in.	
6	1/8	-6M0-61-2

Male Connectors

NPT



Tube OD in.	NPT Size in.	Basic Ordering Number
1/16	1/16	-100-1-1
	1/8	-100-1-2
	1/4	-100-1-4
1/8	1/16	-200-1-1
	1/8	-200-1-2
	1/4	-200-1-4
	3/8	-200-1-6
	1/2	-200-1-8
3/16	1/8	-300-1-2
	1/4	-300-1-4
1/4	1/16	-400-1-1
	1/8	-400-1-2
	1/4	-400-1-4
	3/8	-400-1-6
	1/2	-400-1-8
	3/4	-400-1-12
5/16	1/8	-500-1-2
	1/4	-500-1-4
	3/8	-500-1-6
3/8	1/8	-600-1-2
	1/4	-600-1-4
	3/8	-600-1-6
	1/2	-600-1-8
	3/4	-600-1-12
	1	-600-1-16
1/2	1/8	-810-1-2
	1/4	-810-1-4
	3/8	-810-1-6
	1/2	-810-1-8
	3/4	-810-1-12
	1	-810-1-16

Tube OD in.	NPT Size in.	Basic Ordering Number
5/8	1/4	-1010-1-4
	3/8	-1010-1-6
	1/2	-1010-1-8
	3/4	-1010-1-12
3/4	3/8	-1210-1-6
	1/2	-1210-1-8
	3/4	-1210-1-12
	1	-1210-1-16
7/8	1/2	-1410-1-8
	3/4	-1410-1-12
	1	-1410-1-16
1	1/2	-1610-1-8
	3/4	-1610-1-12
	1	-1610-1-16
1 1/8	1	-1810-1-16
1 1/4	1	-2000-1-16
	1 1/4	-2000-1-20
1 1/2	1 1/2	-2400-1-24
2	2	-3200-1-32

Installation

Straight Fittings

Elbows and Tees

Adapters

Parts

Accessories

Male Connectors

NPT



Tube OD mm	NPT Size in.	Basic Ordering Number
2	1/8	-2M0-1-2
3	1/8	-3M0-1-2
	1/4	-3M0-1-4
4	1/8	-4M0-1-2
	1/4	-4M0-1-4
6	1/8	-6M0-1-2
	1/4	-6M0-1-4
	3/8	-6M0-1-6
	1/2	-6M0-1-8
8	1/8	-8M0-1-2
	1/4	-8M0-1-4
	3/8	-8M0-1-6
	1/2	-8M0-1-8
10	1/8	-10M0-1-2
	1/4	-10M0-1-4
	3/8	-10M0-1-6
	1/2	-10M0-1-8
	3/4	-10M0-1-12
12	1/8	-12M0-1-2
	1/4	-12M0-1-4
	3/8	-12M0-1-6
	1/2	-12M0-1-8
	3/4	-12M0-1-12
14	1/4	-14M0-1-4
	3/8	-14M0-1-6
	1/2	-14M0-1-8
15	1/2	-15M0-1-8
16	3/8	-16M0-1-6
	1/2	-16M0-1-8
	3/4	-16M0-1-12
18	1/2	-18M0-1-8
	3/4	-18M0-1-12
20	1/2	-20M0-1-8
	3/4	-20M0-1-12
22	3/4	-22M0-1-12
	1	-22M0-1-16
25	1/2	-25M0-1-8
	3/4	-25M0-1-12
	1	-25M0-1-16
28	1	-28M0-1-16
	1 1/4	-28M0-1-20
30	1 1/4	-30M0-1-20
32	1 1/4	-32M0-1-20
38	1 1/2	-38M0-1-24

Male Connectors

ISO/BSP Tapered Thread (RT)



Tube OD in.	ISO Thread Size in.	Basic Ordering Number
1/8	1/8 1/4	-200-1-2RT -200-1-4RT
1/4	1/8 1/4 3/8 1/2	-400-1-2RT -400-1-4RT -400-1-6RT -400-1-8RT
5/16	1/8 1/4	-500-1-2RT -500-1-4RT
3/8	1/8 1/4 3/8 1/2 3/4	-600-1-2RT -600-1-4RT -600-1-6RT -600-1-8RT -600-1-12RT
1/2	1/4 3/8 1/2 3/4	-810-1-4RT -810-1-6RT -810-1-8RT -810-1-12RT
5/8	1/2	-1010-1-8RT
3/4	3/4 1	-1210-1-12RT -1210-1-16RT
1	3/4 1	-1610-1-12RT -1610-1-16RT
1 1/4	1 1/4	-2000-1-20RT

Installation

Straight Fittings

Elbows and Tees

Adapters

Parts

Accessories

Male Connectors

ISO/BSP Tapered Thread (RT)

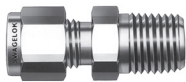

Tube OD mm	ISO Thread Size in.	Basic Ordering Number
2	1/8	-2M0-1-2RT
3	1/8	-3M0-1-2RT
	1/4	-3M0-1-4RT
4	1/8	-4M0-1-2RT
	1/4	-4M0-1-4RT
6	1/8	-6M0-1-2RT
	1/4	-6M0-1-4RT
	3/8	-6M0-1-6RT
	1/2	-6M0-1-8RT
8	1/8	-8M0-1-2RT
	1/4	-8M0-1-4RT
	3/8	-8M0-1-6RT
	1/2	-8M0-1-8RT
10	1/8	-10M0-1-2RT
	1/4	-10M0-1-4RT
	3/8	-10M0-1-6RT
	1/2	-10M0-1-8RT
	3/4	-10M0-1-12RT
12	1/4	-12M0-1-4RT
	3/8	-12M0-1-6RT
	1/2	-12M0-1-8RT
	3/4	-12M0-1-12RT
14	1/4	-14M0-1-4RT
	3/8	-14M0-1-6RT
15	1/2	-15M0-1-8RT
16	1/4	-16M0-1-4RT
	3/8	-16M0-1-6RT
	1/2	-16M0-1-8RT
	3/4	-16M0-1-12RT
18	1/2	-18M0-1-8RT
	3/4	-18M0-1-12RT
20	1/2	-20M0-1-8RT
	3/4	-20M0-1-12RT
22	3/4	-22M0-1-12RT
	1	-22M0-1-16RT
25	1/2	-25M0-1-8RT
	3/4	-25M0-1-12RT
	1	-25M0-1-16RT
28	1	-28M0-1-16RT
	1 1/4	-28M0-1-20RT
30	1 1/4	-30M0-1-20RT
32	1 1/4	-32M0-1-20RT
38	1 1/2	-38M0-1-24RT

Male Connectors

ISO/BSP Parallel Thread (RS)

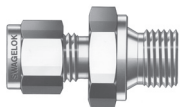

Tube OD in.	ISO Thread Size in.	Basic Ordering Number
1/8	1/8 1/4 3/8	-200-1-2RS -200-1-4RS -200-1-6RS
1/4	1/8 1/4 3/8 1/2	-400-1-2RS -400-1-4RS -400-1-6RS -400-1-8RS
3/8	1/8 1/4 3/8 1/2	-600-1-2RS -600-1-4RS -600-1-6RS -600-1-8RS
1/2	1/4 3/8 1/2	-810-1-4RS -810-1-6RS -810-1-8RS
3/4	1/2 3/4	-1210-1-8RS -1210-1-12RS
1	1/2 3/4 1	-1610-1-8RS -1610-1-12RS -1610-1-16RS

Installation

Straight Fittings

Elbows and Tees

Adapters

Parts

Accessories

Male Connectors

ISO/BSP Parallel Thread (RS)

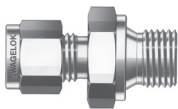

Tube OD mm	ISO Thread Size in.	Basic Ordering Number
2	1/8	-2M0-1-2RS
3	1/8	-3M0-1-2RS
	1/4	-3M0-1-4RS
4	1/8	-4M0-1-2RS
6	1/8	-6M0-1-2RS
	1/4	-6M0-1-4RS
	3/8	-6M0-1-6RS
	1/2	-6M0-1-8RS
8	1/8	-8M0-1-2RS
	1/4	-8M0-1-4RS
	3/8	-8M0-1-6RS
	1/2	-8M0-1-8RS
10	1/4	-10M0-1-4RS
	3/8	-10M0-1-6RS
	1/2	-10M0-1-8RS
12	1/4	-12M0-1-4RS
	3/8	-12M0-1-6RS
	1/2	-12M0-1-8RS
	3/4	-12M0-1-12RS
14	3/8	-14M0-1-6RS
	1/2	-14M0-1-8RS
15	3/8	-15M0-1-6RS
	1/2	-15M0-1-8RS
	3/4	-15M0-1-12RS
16	3/8	-16M0-1-6RS
	1/2	-16M0-1-8RS
	3/4	-16M0-1-12RS
18	1/2	-18M0-1-8RS
	3/4	-18M0-1-12RS
20	1/2	-20M0-1-8RS
	3/4	-20M0-1-12RS
22	3/4	-22M0-1-12RS
	1	-22M0-1-16RS
25	3/4	-25M0-1-12RS
	1	-25M0-1-16RS
28	1	-28M0-1-16RS
	1 1/4	-28M0-1-20RS
30	1 1/4	-30M0-1-20RS
32	1 1/4	-32M0-1-20RS
38	1 1/2	-38M0-1-24RS

Male Connectors

ISO/BSP Parallel Thread (RP)



Tube OD in.	ISO Thread Size in.	Basic Ordering Number
1/8	1/8 1/4	-200-1-2RP -200-1-4RP
1/4	1/8 1/4	-400-1-2RP -400-1-4RP
1/2	3/8 1/2	-810-1-6RP -810-1-8RP
3/4	1/2 3/4	-1210-1-8RP -1210-1-12RP
1	1	-1610-1-16RP

Installation

Straight Fittings

Elbows and Tees

Adapters

Parts

Accessories

Male Connectors

ISO/BSP Parallel Thread (RP)

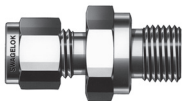

Tube OD mm	ISO Thread Size in.	Basic Ordering Number
3	1/8	-3M0-1-2RP
	1/4	-3M0-1-4RP
4	1/8	-4M0-1-2RP
6	1/8	-6M0-1-2RP
	1/4	-6M0-1-4RP
	3/8	-6M0-1-6RP
	1/2	-6M0-1-8RP
8	1/8	-8M0-1-2RP
	1/4	-8M0-1-4RP
	3/8	-8M0-1-6RP
	1/2	-8M0-1-8RP
10	1/4	-10M0-1-4RP
	3/8	-10M0-1-6RP
	1/2	-10M0-1-8RP
12	1/4	-12M0-1-4RP
	3/8	-12M0-1-6RP
	1/2	-12M0-1-8RP
	3/4	-12M0-1-12RP
15	1/2	-15M0-1-8RP
16	3/8	-16M0-1-6RP
	1/2	-16M0-1-8RP
18	1/2	-18M0-1-8RP
	3/4	-18M0-1-12RP
20	1/2	-20M0-1-8RP
	3/4	-20M0-1-12RP
22	3/4	-22M0-1-12RP
	1	-22M0-1-16RP
25	3/4	-25M0-1-12RP
	1	-25M0-1-16RP
28	1	-28M0-1-16RP
	1 1/4	-28M0-1-20RP
30	1 1/4	-30M0-1-20RP
32	1 1/4	-32M0-1-20RP
38	1 1/2	-38M0-1-24RP

Male Connectors

Bulkhead NPT



Tube OD in.	NPT Size in.	Basic Ordering Number
1/8	1/8	-200-11-2
1/4	1/8 1/4	-400-11-2 -400-11-4
3/8	1/4 3/8 1/2	-600-11-4 -600-11-6 -600-11-8
1/2	3/8 1/2	-810-11-6 -810-11-8
3/4	3/4	-1210-11-12
1	1	-1610-11-16

Tube OD mm	NPT Size in.	Basic Ordering Number
6	1/8 1/4	-6M0-11-2 -6M0-11-4
12	1/2	-12M0-11-8

Installation

Straight Fittings

Elbows and Tees

Adapters

Parts

Accessories

Male Connectors

SAE/MS Straight Thread (ST)

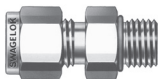

Tube OD in.	SAE/MS Thread Size	Basic Ordering Number
1/8	5/16-24 7/16-20 9/16-18	-200-1-2ST -200-1-4ST -200-1-6ST
1/4	5/16-24 7/16-20 9/16-18 3/4-16 7/8-14	-400-1-2ST -400-1-4ST -400-1-6ST -400-1-8ST -400-1-10ST
5/16	1/2-20	-500-1-5ST
3/8	7/16-20 9/16-18 3/4-16 7/8-14	-600-1-4ST -600-1-6ST -600-1-8ST -600-1-10ST
1/2	9/16-18 3/4-16 7/8-14 1 1/16-12	-810-1-6ST -810-1-8ST -810-1-10ST -810-1-12ST
5/8	3/4-16 7/8-14	-1010-1-8ST -1010-1-10ST
3/4	3/4-16 1 1/16-12 1 5/16-12	-1210-1-8ST -1210-1-12ST -1210-1-16ST
7/8	1 3/16-12	-1410-1-14ST
1	1 1/16-12 1 5/16-12	-1610-1-12ST -1610-1-16ST
1 1/4	1 5/8-12	-2000-1-20ST
1 1/2	1 7/8-12	-2400-1-24ST
2	2 1/2-12	-3200-1-32ST

Tube OD mm	SAE/MS Thread Size	Basic Ordering Number
6	9/16-18	-6M0-1-6ST
10	9/16-18 3/4-16	-10M0-1-6ST -10M0-1-8ST
12	7/16-20 9/16-18 3/4-16	-12M0-1-4ST -12M0-1-6ST -12M0-1-8ST

Tube OD in.	SAE/MS Thread Size	Basic Ordering Number
1/4	7/16-20	-400-1L-4ST
1/2	3/4-16	-810-1L-8ST

Long SAE/MS Straight Thread (ST)

Male Connectors

O-Seal (SAE/MS Straight Thread)



Tube OD in.	SAE/MS Thread Size	Basic Ordering Number
1/16	5/16-24	-100-1-OR
1/8	5/16-24	-200-1-OR
3/16	3/8-24	-300-1-OR
1/4	7/16-20	-400-1-OR
5/16	1/2-20	-500-1-OR
3/8	9/16-18	-600-1-OR
1/2	3/4-16	-810-1-OR
3/4	1 1/16-12	-1210-1-OR
1	1 5/16-12	-1610-1-OR

O-Seal (NPT)

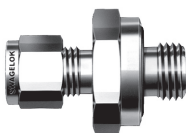

Tube OD in.	NPT Size in.	Basic Ordering Number
1/8	1/8	-200-1-2-OR
1/4	1/8	-400-1-2-OR
	1/4	-400-1-4-OR
3/8	1/4	-600-1-4-OR
	3/8	-600-1-6-OR
	1/2	-600-1-8-OR
1/2	1/2	-810-1-8-OR

Installation

Straight Fittings

Elbows and Tees

Adapters

Parts

Accessories

Male Connectors

AN Fitting



Tube OD in.	AN Tube Flare Size in.	Basic Ordering Number
1/16	1/8	-100-6-2AN
1/8	1/8 1/4	-200-6-2AN -200-6-4AN
1/4	1/4	-400-6-4AN
5/16	5/16	-500-6-5AN
3/8	1/4 3/8	-600-6-4AN -600-6-6AN
1/2	1/2	-810-6-8AN
3/4	3/4	-1210-6-12AN
1	1	-1610-6-16AN

AN Bulkhead Fitting



Tube OD in.	AN Tube Flare Size in.	Basic Ordering Number
1/4	1/4	-400-61-4AN
3/8	3/8	-600-61-6AN
1/2	1/2	-810-61-8AN
3/4	3/4	-1210-61-12AN
1	1	-1610-61-16AN

Male Connectors

10-32 Thread



Tube OD in.	Basic Ordering Number
1/8	-200-1-0157
1/4	-400-1-0256

M5 × 0.8 Thread



Tube OD mm	Basic Ordering Number
6	-6M0-1-0046

Metric Thread (RS)

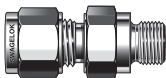

Tube OD mm	Basic Ordering Number
6	-6M0-1-M10X1.0RS -6M0-1-M12X1.0RS
12	-12M0-1-M16X1.5RS

Installation

Straight Fittings

Elbows and Tees

Adapters

Parts

Accessories

Weld Connectors

Installation

Straight Fittings

Tube Socket Weld



Tube OD in.	Socket Weld Size in.	Basic Ordering Number
1/8	1/8	-200-6-2W
1/4	1/4	-400-6-4W
3/8	3/8	-600-6-6W
1/2	1/2	-810-6-8W
3/4	3/4	-1210-6-12W
1	1	-1610-6-16W

Elbows and Tees

Adapters

Parts

Accessories

Male Pipe Weld (Fractional)

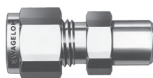

Tube OD in.	Pipe Weld Size in.	Basic Ordering Number
1/8	1/8	-200-1-2W
3/16	1/8	-300-1-2W
1/4	1/8 1/4	-400-1-2W -400-1-4W
5/16	1/8 1/4	-500-1-2W -500-1-4W
3/8	1/4 3/8 1/2 3/4	-600-1-4W -600-1-6W -600-1-8W -600-1-12W
1/2	3/8 1/2 3/4 1	-810-1-6W -810-1-8W -810-1-12W -810-1-16W
5/8	1/2	-1010-1-8W
3/4	1/2 3/4	-1210-1-8W -1210-1-12W
1	1	-1610-1-16W
1 1/4	1 1/4	-2000-1-20W
1 1/2	1 1/2	-2400-1-24W
2	2	-3200-1-32W

Weld Connectors

Male Pipe Weld (Metric to Fractional)

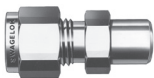

Tube OD mm	Pipe Weld Size in.	Basic Ordering Number
3	1/8	-3M0-1-2W
4	1/8	-4M0-1-2W
6	1/8	-6M0-1-2W
	1/4	-6M0-1-4W
8	1/8	-8M0-1-2W
	1/4	-8M0-1-4W
	1/2	-8M0-1-8W
10	1/4	-10M0-1-4W
	3/8	-10M0-1-6W
	1/2	-10M0-1-8W
12	1/4	-12M0-1-4W
	3/8	-12M0-1-6W
	1/2	-12M0-1-8W
	3/4	-12M0-1-12W
14	3/8	-14M0-1-6W
15	1/2	-15M0-1-8W
16	1/2	-16M0-1-8W
18	1/2	-18M0-1-8W
30	1 1/4	-30M0-1-20W
32	1 1/4	-32M0-1-20W
38	1 1/2	-38M0-1-24W

Installation

Straight Fittings

Elbows and Tees

Adapters

Parts

Accessories

Female Connectors

Installation

Straight Fittings

Elbows and Tees

Adapters

Parts

Accessories

NPT

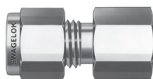

Tube OD in.	NPT Size in.	Basic Ordering Number
1/16	1/16	-100-7-1
	1/8	-100-7-2
1/8	1/8	-200-7-2
	1/4	-200-7-4
3/16	1/8	-300-7-2
1/4	1/8	-400-7-2
	1/4	-400-7-4
	3/8	-400-7-6
	1/2	-400-7-8
5/16	1/8	-500-7-2
	1/4	-500-7-4
3/8	1/8	-600-7-2
	1/4	-600-7-4
	3/8	-600-7-6
	1/2	-600-7-8
	3/4	-600-7-12
1/2	1/4	-810-7-4
	3/8	-810-7-6
	1/2	-810-7-8
	3/4	-810-7-12
5/8	3/8	-1010-7-6
	1/2	-1010-7-8
	3/4	-1010-7-12
3/4	1/2	-1210-7-8
	3/4	-1210-7-12
7/8	3/4	-1410-7-12
1	3/4	-1610-7-12
	1	-1610-7-16
1 1/4	1 1/4	-2000-7-20
1 1/2	1 1/2	-2400-7-24
2	2	-3200-7-32

Female Connectors

NPT

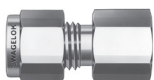

Tube OD mm	NPT Size in.	Basic Ordering Number
3	1/8	-3M0-7-2
	1/4	-3M0-7-4
4	1/8	-4M0-7-2
6	1/8	-6M0-7-2
	1/4	-6M0-7-4
	3/8	-6M0-7-6
	1/2	-6M0-7-8
8	1/8	-8M0-7-2
	1/4	-8M0-7-4
	3/8	-8M0-7-6
	1/2	-8M0-7-8
10	1/4	-10M0-7-4
	3/8	-10M0-7-6
	1/2	-10M0-7-8
12	1/4	-12M0-7-4
	3/8	-12M0-7-6
	1/2	-12M0-7-8
15	1/2	-15M0-7-8
16	1/2	-16M0-7-8
20	1/2	-20M0-7-8
	3/4	-20M0-7-12
22	3/4	-22M0-7-12
	1	-22M0-7-16
25	3/4	-25M0-7-12
	1	-25M0-7-16

Installation

Straight Fittings

Elbows and Tees

Adapters

Parts

Accessories

Female Connectors

ISO/BSP Tapered Thread (RT)

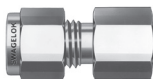

Tube OD in.	ISO Thread Size in.	Basic Ordering Number
1/8	1/8	-200-7-2RT
1/4	1/8	-400-7-2RT
	1/4	-400-7-4RT
	3/8	-400-7-6RT
	1/2	-400-7-8RT
3/8	1/4	-600-7-4RT
	3/8	-600-7-6RT
	1/2	-600-7-8RT
1/2	1/4	-810-7-4RT
	3/8	-810-7-6RT
	1/2	-810-7-8RT

Tube OD mm	ISO Thread Size in.	Basic Ordering Number
3	1/8	-3M0-7-2RT
6	1/8	-6M0-7-2RT
	1/4	-6M0-7-4RT
	3/8	-6M0-7-6RT
	1/2	-6M0-7-8RT
8	1/8	-8M0-7-2RT
	1/4	-8M0-7-4RT
	3/8	-8M0-7-6RT
	1/2	-8M0-7-8RT
10	1/8	-10M0-7-2RT
	1/4	-10M0-7-4RT
	3/8	-10M0-7-6RT
	1/2	-10M0-7-8RT
12	1/8	-12M0-7-2RT
	1/4	-12M0-7-4RT
	3/8	-12M0-7-6RT
	1/2	-12M0-7-8RT
	3/4	-12M0-7-12RT
15	3/8	-15M0-7-6RT
	1/2	-15M0-7-8RT
20	1/2	-20M0-7-8RT
	3/4	-20M0-7-12RT
22	3/4	-22M0-7-12RT
	1	-22M0-7-16RT
25	3/4	-25M0-7-12RT
	1	-25M0-7-16RT

Female Connectors

ISO/BSP Parallel Thread (RJ)

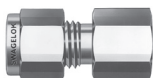

Tube OD in.	ISO Thread Size in.	Ordering Number
1/4	1/4 3/8 1/2	SS-400-7-4RJ SS-400-7-6RJ SS-400-7-8RJ
5/16	1/4 1/2	SS-500-7-4RJ SS-500-7-8RJ
3/8	1/4 3/8 1/2	SS-600-7-4RJ SS-600-7-6RJ SS-600-7-8RJ
1/2	1/4 3/8 1/2	SS-810-7-4RJ SS-810-7-6RJ SS-810-7-8RJ

Tube OD mm.	ISO Thread Size in.	Ordering Number
6	1/4 3/8 1/2	SS-6M0-7-4RJ SS-6M0-7-6RJ SS-6M0-7-8RJ
8	1/4 3/8 1/2	SS-8M0-7-4RJ SS-8M0-7-6RJ SS-8M0-7-8RJ
10	1/4 3/8 1/2	SS-10M0-7-4RJ SS-10M0-7-6RJ SS-10M0-7-8RJ
12	1/4 3/8 1/2	SS-12M0-7-4RJ SS-12M0-7-6RJ SS-12M0-7-8RJ

ISO/BSP Parallel Thread (RP)

Tube OD mm	ISO Thread Size in.	Basic Ordering Number
6	1/8 1/4	-6M0-7-2RP -6M0-7-4RP
22	3/4	-22M0-7-12RP
25	1	-25M0-7-16RP

Installation

Straight Fittings

Elbows and Tees

Adapters

Parts

Accessories

Female Connectors

Installation

Straight Fittings

Elbows and Tees

Adapters

Parts

Accessories

ISO/BSP Parallel Thread (RG, Gauge)

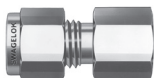

Tube OD in.	ISO Thread Size in.	Basic Ordering Number
1/8	1/4	-200-7-4RG
1/4	1/8	-400-7-2RG
	1/4	-400-7-4RG
	3/8	-400-7-6RG
	1/2	-400-7-8RG
5/16	1/4	-500-7-4RG
	1/2	-500-7-8RG
3/8	1/4	-600-7-4RG
	3/8	-600-7-6RG
	1/2	-600-7-8RG
1/2	3/8	-810-7-6RG
	1/2	-810-7-8RG

Tube OD mm	ISO Thread Size in.	Basic Ordering Number
3	1/4	-3M0-7-4RG
6	1/8	-6M0-7-2RG
	1/4	-6M0-7-4RG
	3/8	-6M0-7-6RG
	1/2	-6M0-7-8RG
8	1/4	-8M0-7-4RG
	3/8	-8M0-7-6RG
	1/2	-8M0-7-8RG
10	1/4	-10M0-7-4RG
	3/8	-10M0-7-6RG
	1/2	-10M0-7-8RG
12	1/4	-12M0-7-4RG
	3/8	-12M0-7-6RG
	1/2	-12M0-7-8RG
20	1/2	-20M0-7-8RG
22	1/2	-22M0-7-8RG

Female Connectors

Bulkhead NPT

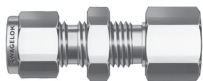

Tube OD in.	NPT Size in.	Basic Ordering Number
1/8	1/8	-200-71-2
1/4	1/8 1/4	-400-71-2 -400-71-4
3/8	1/4	-600-71-4
1/2	3/8 1/2	-810-71-6 -810-71-8

Tube OD mm	NPT Size in.	Basic Ordering Number
6	1/4	-6M0-71-4
12	1/2	-12M0-71-8

Installation

Straight Fittings

Elbows and Tees

Adapters

Parts

Accessories

Reducers

Reducer (Fractional)



1 in. and Under



Over 1 in.

Tube OD, in.		Basic Ordering Number
T	Tx	
1/16	1/8 1/4	-100-R-2 -100-R-4
1/8	1/16 1/8 3/16 1/4 3/8 1/2	-200-R-1 -200-R-2 -200-R-3 -200-R-4 -200-R-6 -200-R-8
3/16	1/8 1/4	-300-R-2 -300-R-4
1/4	1/8 3/16 1/4 5/16 3/8 1/2 5/8 3/4	-400-R-2 -400-R-3 -400-R-4 -400-R-5 -400-R-6 -400-R-8 -400-R-8 -400-R-10 -400-R-12
5/16	3/8 1/2	-500-R-6 -500-R-8
3/8	1/4 3/8 1/2 5/8 3/4	-600-R-4 -600-R-6 -600-R-8 -600-R-10 -600-R-12
1/2	1/4 3/8 1/2 5/8 3/4 1	-810-R-4 -810-R-6 -810-R-8 -810-R-10 -810-R-12 -810-R-16
5/8	3/4 7/8 1	-1010-R-12 -1010-R-14 -1010-R-16
3/4	1/2 1	-1210-R-8 -1210-R-16
1	1 1/4 1 1/2 2	-1610-R-20 ^① -1610-R-24 ^① -1610-R-32 ^①
1 1/4	1 1/2 2	-2000-R-24 ^① -2000-R-32 ^①
1 1/2	2	-2400-R-32 ^①

① Furnished with nut and preswaged ferrules.

Reducers

Reducer (Metric)



Tube OD, mm		Basic Ordering Number
T	Tx	
2	3	-2M0-R-3M
3	4	-3M0-R-4M
	6	-3M0-R-6M
	10	-3M0-R-10M
4	6	-4M0-R-6M
6	3	-6M0-R-3M
	8	-6M0-R-8M
	10	-6M0-R-10M
	12	-6M0-R-12M
	18	-6M0-R-18M
8	6	-8M0-R-6M
	10	-8M0-R-10M
	12	-8M0-R-12M
10	6	-10M0-R-6M
	8	-10M0-R-8M
	12	-10M0-R-12M
	15	-10M0-R-15M
	18	-10M0-R-18M
12	6	-12M0-R-6M
	8	-12M0-R-8M
	10	-12M0-R-10M
	16	-12M0-R-16M
	18	-12M0-R-18M
	20	-12M0-R-20M
	22	-12M0-R-22M
	25	-12M0-R-25M
16	12	-16M0-R-12M
18	12	-18M0-R-12M
	16	-18M0-R-16M
	20	-18M0-R-20M
	22	-18M0-R-22M
	25	-18M0-R-25M
20	16	-20M0-R-16M
	18	-20M0-R-18M
	22	-20M0-R-22M
	25	-20M0-R-25M
22	18	-22M0-R-18M
	20	-22M0-R-20M
	25	-22M0-R-25M
25	18	-25M0-R-18M
	20	-25M0-R-20M

Installation

Straight Fittings

Elbows and Tees

Adapters

Parts

Accessories

Reducers

Reducer (Metric to Fractional)

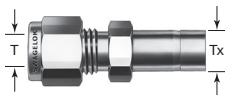

Tube OD		Basic Ordering Number
T, mm	Tx, in.	
2	1/8	-2M0-R-2
3	1/8	-3M0-R-2
	1/4	-3M0-R-4
4	1/4	-4M0-R-4
6	1/8	-6M0-R-2
	1/4	-6M0-R-4
	5/16	-6M0-R-5
	3/8	-6M0-R-6
	1/2	-6M0-R-8
8	1/4	-8M0-R-4
	3/8	-8M0-R-6
	1/2	-8M0-R-8
10	3/8	-10M0-R-6
	1/2	-10M0-R-8
12	1/2	-12M0-R-8
	3/4	-12M0-R-12
18	3/4	-18M0-R-12
	1	-18M0-R-16
25	1	-25M0-R-16

Reducer (Fractional to Metric)

Tube OD		Basic Ordering Number
T, in.	Tx, mm	
1/8	6	-200-R-6M

Reducers

Long Reducer



Use only long reducers in female Swagelok end connections.

Tube OD, in.		Basic Ordering Number
T	Tx	
3/8	1/2	-600-RF-8

Bulkhead Reducer



Tube OD in,	Basic Ordering Number
1/8	-200-R1-2
1/4	-400-R1-4
3/8	-600-R1-6
1/2	-810-R1-8
5/8	-1010-R1-10
3/4	-1210-R1-12
1	-1610-R1-16

Installation

Straight Fittings

Elbows and Tees

Adapters

Parts

Accessories

Port Connectors

Installation

Port Connector



1 in./25 mm and Under



Over 1 in./25 mm

Straight Fittings

Elbows and Tees

Adapters

Parts

Accessories

Tube OD in.	Basic Ordering Number
1/16	-101-PC
1/8	-201-PC
1/4	-401-PC
5/16	-501-PC
3/8	-601-PC
1/2	-811-PC
5/8	-1011-PC
3/4	-1211-PC
1	-1611-PC
1 1/4	-2000-PC ^①
1 1/2	-2400-PC ^①
2	-3200-PC ^①

① Furnished with nut and preswaged ferrules.

Tube OD mm	Basic Ordering Number
3	-3M1-PC
6	-6M1-PC
8	-8M1-PC
10	-10M1-PC
12	-12M1-PC
15	-15M1-PC
16	-16M1-PC
18	-18M1-PC
20	-20M1-PC
25	-25M1-PC
28	-28M0-PC ^①
30	-30M0-PC ^①
32	-32M0-PC ^①
38	-38M0-PC ^①

① Furnished with nut and preswaged ferrules.

Port Connectors

Reducing Port Connector



Tube OD, in.		Basic Ordering Number
T	Tx	
1/8	1/16	-201-PC-1
1/4	1/16	-401-PC-1
	1/8	-401-PC-2
3/8	1/8	-601-PC-2
	1/4	-601-PC-4
1/2	1/4	-811-PC-4
	3/8	-811-PC-6
3/4	1/2	-1211-PC-8
1	1/2	-1611-PC-8
	3/4	-1611-PC-12

Tube OD, mm		Basic Ordering Number
T	Tx	
6	3	-6M1-PC-3M
8	6	-8M1-PC-6M
10	6	-10M1-PC-6M
	8	-10M1-PC-8M
12	6	-12M1-PC-6M
	8	-12M1-PC-8M
	10	-12M1-PC-10M
16	12	-16M1-PC-12M
28	25	-28M1-PC-25M
32	25	-32M1-PC-25M
38	25	-38M1-PC-25M

Installation

Straight Fittings

Elbows and Tees

Adapters

Parts

Accessories

Caps and Plugs

Installation

Cap

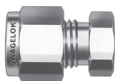

Straight Fittings

Elbows and Tees

Adapters

Parts

Accessories

Tube OD in.	Basic Ordering Number
1/16	-100-C
1/8	-200-C
3/16	-300-C
1/4	-400-C
5/16	-500-C
3/8	-600-C
1/2	-810-C
5/8	-1010-C
3/4	-1210-C
7/8	-1410-C
1	-1610-C
1 1/8	-1810-C
1 1/4	-2000-C
1 1/2	-2400-C
2	-3200-C

Tube OD mm	Basic Ordering Number
2	-2M0-C
3	-3M0-C
4	-4M0-C
6	-6M0-C
8	-8M0-C
10	-10M0-C
12	-12M0-C
14	-14M0-C
15	-15M0-C
16	-16M0-C
18	-18M0-C
20	-20M0-C
22	-22M0-C
25	-25M0-C
28	-28M0-C
30	-30M0-C
32	-32M0-C
38	-38M0-C

Caps and Plugs

Plug



Tube OD in.	Basic Ordering Number
1/16	-100-P
1/8	-200-P
3/16	-300-P
1/4	-400-P
5/16	-500-P
3/8	-600-P
1/2	-810-P
5/8	-1010-P
3/4	-1210-P
7/8	-1410-P
1	-1610-P
1 1/4	-2000-P
1 1/2	-2400-P
2	-3200-P

Tube OD mm	Basic Ordering Number
2	-2M0-P
3	-3M0-P
4	-4M0-P
6	-6M0-P
8	-8M0-P
10	-10M0-P
12	-12M0-P
15	-15M0-P
16	-16M0-P
18	-18M0-P
20	-20M0-P
22	-22M0-P
25	-25M0-P
28	-28M0-P
30	-30M0-P
32	-32M0-P
38	-38M0-P

Installation

Straight Fittings

Elbows and Tees

Adapters

Parts

Accessories

Vent Protectors

Mud Dauber

Swagelok vent protectors, more commonly known as **mud dauber fittings**, protect open ends of instruments, tubing, outlet vents, and bleed-off lines.

The mesh wire screen prevents foreign objects, such as mud dauber insects, from entering and clogging various systems and causing damage.

Vent protectors are available in stainless steel and brass. To order brass, replace **SS** in the ordering number with **B**.

Example: **B**-MD-2



NPT Size in.	Ordering Number
1/8	SS-MD-2
1/4	SS-MD-4
3/8	SS-MD-6
1/2	SS-MD-8
3/4	SS-MD-12

Elbows Unions



Tube OD in.	Basic Ordering Number
1/16	-100-9
1/8	-200-9
3/16	-300-9
1/4	-400-9
5/16	-500-9
3/8	-600-9
1/2	-810-9
5/8	-1010-9
3/4	-1210-9
7/8	-1410-9
1	-1610-9
1 1/8	-1810-9
1 1/4	-2000-9
1 1/2	-2400-9
2	-3200-9

Tube OD mm	Basic Ordering Number
3	-3M0-9
4	-4M0-9
6	-6M0-9
8	-8M0-9
10	-10M0-9
12	-12M0-9
14	-14M0-9
15	-15M0-9
16	-16M0-9
18	-18M0-9
20	-20M0-9
22	-22M0-9
25	-25M0-9
28	-28M0-9
30	-30M0-9
32	-32M0-9
38	-38M0-9
50	-50M0-9

Installation

Straight Fittings

Elbows and Tees

Adapters

Parts

Accessories

Male

NPT



Tube OD in.	NPT Size in.	Basic Ordering Number
1/16	1/16 1/8	-100-2-1 -100-2-2
1/8	1/16 1/8 1/4	-200-2-1 -200-2-2 -200-2-4
3/16	1/8 1/4	-300-2-2 -300-2-4
1/4	1/16 1/8 1/4 3/8 1/2	-400-2-1 -400-2-2 -400-2-4 -400-2-6 -400-2-8
5/16	1/8 1/4 3/8	-500-2-2 -500-2-4 -500-2-6
3/8	1/8 1/4 3/8 1/2 3/4	-600-2-2 -600-2-4 -600-2-6 -600-2-8 -600-2-12
1/2	1/4 3/8 1/2 3/4	-810-2-4 -810-2-6 -810-2-8 -810-2-12
5/8	3/8 1/2 3/4	-1010-2-6 -1010-2-8 -1010-2-12
3/4	1/2 3/4	-1210-2-8 -1210-2-12
7/8	3/4	-1410-2-12
1	3/4 1	-1610-2-12 -1610-2-16
1 1/4	1 1/4	-2000-2-20
1 1/2	1 1/2	-2400-2-24
2	2	-3200-2-32

Male

NPT



Tube OD mm	NPT Size in.	Basic Ordering Number
3	1/8	-3M0-2-2
	1/4	-3M0-2-4
4	1/8	-4M0-2-2
	1/4	-4M0-2-4
6	1/8	-6M0-2-2
	1/4	-6M0-2-4
	3/8	-6M0-2-6
	1/2	-6M0-2-8
8	1/8	-8M0-2-2
	1/4	-8M0-2-4
	3/8	-8M0-2-6
	1/2	-8M0-2-8
10	1/8	-10M0-2-2
	1/4	-10M0-2-4
	3/8	-10M0-2-6
	1/2	-10M0-2-8
12	1/4	-12M0-2-4
	3/8	-12M0-2-6
	1/2	-12M0-2-8
	3/4	-12M0-2-12
15	1/2	-15M0-2-8
16	3/8	-16M0-2-6
	1/2	-16M0-2-8
	3/4	-16M0-2-12
18	1/2	-18M0-2-8
	3/4	-18M0-2-12
20	1/2	-20M0-2-8
	3/4	-20M0-2-12
22	3/4	-22M0-2-12
	1	-22M0-2-16
25	3/4	-25M0-2-12
	1	-25M0-2-16
30	1 1/4	-30M0-2-20
32	1 1/4	-32M0-2-20
38	1 1/2	-38M0-2-24

Installation

Straight Fittings

Elbows and Tees

Adapters

Parts

Accessories

Male

ISO/BSP Tapered Thread (RT)



Tube OD in.	ISO Thread Size in.	Basic Ordering Number
1/8	1/8 1/4	-200-2-2RT -200-2-4RT
1/4	1/8 1/4 3/8 1/2	-400-2-2RT -400-2-4RT -400-2-6RT -400-2-8RT
5/16	1/4	-500-2-4RT
3/8	1/8 1/4 3/8	-600-2-2RT -600-2-4RT -600-2-6RT
1/2	1/4 3/8 1/2	-810-2-4RT -810-2-6RT -810-2-8RT
3/4	1/2	-1210-2-8RT
1	1	-1610-2-16RT

Male

ISO/BSP Tapered Thread (RT)



Tube OD mm	ISO Thread Size in.	Basic Ordering Number
3	1/8	-3M0-2-2RT
	1/4	-3M0-2-4RT
4	1/8	-4M0-2-2RT
	1/4	-4M0-2-4RT
6	1/8	-6M0-2-2RT
	1/4	-6M0-2-4RT
	3/8	-6M0-2-6RT
	1/2	-6M0-2-8RT
8	1/8	-8M0-2-2RT
	1/4	-8M0-2-4RT
	3/8	-8M0-2-6RT
	1/2	-8M0-2-8RT
10	1/4	-10M0-2-4RT
	3/8	-10M0-2-6RT
	1/2	-10M0-2-8RT
12	1/8	-12M0-2-2RT
	1/4	-12M0-2-4RT
	3/8	-12M0-2-6RT
	1/2	-12M0-2-8RT
	3/4	-12M0-2-12RT
14	1/2	-14M0-2-8RT
15	1/2	-15M0-2-8RT
16	3/8	-16M0-2-6RT
	1/2	-16M0-2-8RT
18	1/2	-18M0-2-8RT
	3/4	-18M0-2-12RT
20	1/2	-20M0-2-8RT
	3/4	-20M0-2-12RT
22	3/4	-22M0-2-12RT
	1	-22M0-2-16RT
25	3/4	-25M0-2-12RT
	1	-25M0-2-16RT
28	1	-28M0-2-16RT

Installation

Straight Fittings

Elbows and Tees

Adapters

Parts

Accessories

Male

Reducing

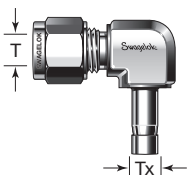

Tube OD, mm		Basic Ordering Number
T	Tx	
6	6	-6M0-2R-6M
12	12	-12M0-2R-12M

Positionable,
SAE/MS
Straight
Thread (ST)

Tube OD in.	SAE/MS Thread Size	Basic Ordering Number
1/4	7/16-20	-400-2-4ST
	9/16-18	-400-2-6ST
5/16	1/2-20	-500-2-5ST
3/8	7/16-20	-600-2-4ST
	9/16-18	-600-2-6ST
	3/4-16	-600-2-8ST
1/2	9/16-18	-810-2-6ST
	3/4-16	-810-2-8ST
5/8	7/8-14	-1010-2-10ST
3/4	1 1/16-12	-1210-2-12ST
7/8	1 3/16-12	-1410-2-14ST
1	1 5/16-12	-1610-2-16ST
1 1/4	1 5/8-12	-2000-2-20ST
1 1/2	1 7/8-12	-2400-2-24ST
2	2 1/2-12	-3200-2-32ST

Male

**Positionable,
ISO/BSP
Parallel
Thread (PR)**



Tube OD in.	ISO Thread Size in.	Basic Ordering Number
1/4	1/8 1/4	-400-2-2PR -400-2-4PR
3/8	1/4 3/8	-600-2-4PR -600-2-6PR
1/2	1/4 3/8 1/2	-810-2-4PR -810-2-6PR -810-2-8PR
5/8	1/2	-1010-2-8PR
3/4	1/2 3/4	-1210-2-8PR -1210-2-12PR
1	3/4 1	-1610-2-12PR -1610-2-16PR

Tube OD mm	ISO Thread Size in.	Basic Ordering Number
6	1/8 1/4	-6M0-2-2PR -6M0-2-4PR
8	1/8 1/4	-8M0-2-2PR -8M0-2-4PR
10	1/4 3/8	-10M0-2-4PR -10M0-2-6PR
12	1/4 3/8 1/2 3/4	-12M0-2-4PR -12M0-2-6PR -12M0-2-8PR -12M0-2-12PR

Installation

Straight Fittings

Elbows and Tees

Adapters

Parts

Accessories

Weld

Tube Socket Weld



Tube OD in.	Socket Weld Size in.	Basic Ordering Number
1/4	1/4	-400-9-4W
3/8	3/8	-600-9-6W
1/2	1/2	-810-9-8W
3/4	3/4	-1210-9-12W
1	1	-1610-9-16W

Male Pipe Weld



Tube OD in.	Pipe Weld Size in.	Basic Ordering Number
1/4	1/8	-400-2-2W
	1/4	-400-2-4W
3/8	1/4	-600-2-4W
1/2	1/2	-810-2-8W
3/4	3/4	-1210-2-12W

Female

NPT



Tube OD in.	NPT Size in.	Basic Ordering Number
1/8	1/8	-200-8-2
	1/4	-200-8-4
3/16	1/8	-300-8-2
1/4	1/8	-400-8-2
	1/4	-400-8-4
	3/8	-400-8-6
	1/2	-400-8-8
5/16	1/8	-500-8-2
	1/4	-500-8-4
3/8	1/8	-600-8-2
	1/4	-600-8-4
	3/8	-600-8-6
	1/2	-600-8-8
1/2	1/4	-810-8-4
	3/8	-810-8-6
	1/2	-810-8-8
5/8	3/8	-1010-8-6
	1/2	-1010-8-8
3/4	1/2	-1210-8-8
	3/4	-1210-8-12
7/8	3/4	-1410-8-12
1	3/4	-1610-8-12
	1	-1610-8-16

Tube OD mm	NPT Size in.	Basic Ordering Number
6	1/8	-6M0-8-2
	1/4	-6M0-8-4
	1/2	-6M0-8-8
8	1/4	-8M0-8-4
10	1/8	-10M0-8-2
	1/4	-10M0-8-4
12	1/4	-12M0-8-4
	1/2	-12M0-8-8
16	1/2	-16M0-8-8

Installation

Straight Fittings

Elbows and Tees

Adapters

Parts

Accessories

Male

NPT



Tube OD in,	NPT Size in,	Basic Ordering Number
1/4	1/8 1/4	-400-5-2 -400-5-4
3/8	1/8 1/4 3/8	-600-5-2 -600-5-4 -600-5-6
1/2	3/8 1/2	-810-5-6 -810-5-8
3/4	3/4	-1210-5-12
1	1	-1610-5-16

Positionable, SAE/MS Straight Thread (ST)

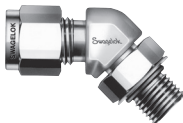

Tube OD in,	SAE/MS Thread Size	Basic Ordering Number
1/4	7/16-20	-400-5-4ST
3/8	9/16-18	-600-5-6ST
1/2	3/4-16	-810-5-8ST
3/4	1 1/16-12	-1210-5-12ST
1	1 5/16-12	-1610-5-16ST

Tees Unions

Union



Tube OD in.	Basic Ordering Number
1/16	-100-3
1/8	-200-3
3/16	-300-3
1/4	-400-3
5/16	-500-3
3/8	-600-3
1/2	-810-3
5/8	-1010-3
3/4	-1210-3
7/8	-1410-3
1	-1610-3
1 1/8	-1810-3
1 1/4	-2000-3
1 1/2	-2400-3
2	-3200-3

Tube OD mm	Basic Ordering Number
2	-2M0-3
3	-3M0-3
4	-4M0-3
6	-6M0-3
8	-8M0-3
10	-10M0-3
12	-12M0-3
14	-14M0-3
15	-15M0-3
16	-16M0-3
18	-18M0-3
20	-20M0-3
22	-22M0-3
25	-25M0-3
28	-28M0-3
30	-30M0-3
32	-32M0-3
38	-38M0-3
50	-50M0-3

Installation

Straight Fittings

Elbows and Tees

Adapters

Parts

Accessories

Unions

Reducing Union

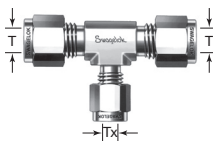

Tube OD, in.		Basic Ordering Number
T	Tx	
3/8	1/4	-600-3-6-4
1/2	1/4	-810-3-8-4
	3/8	-810-3-8-6
5/8	3/8	-1010-3-10-6
3/4	3/8	-1210-3-12-6
	1/2	-1210-3-12-8
1	3/8	-1610-3-16-6
	1/2	-1610-3-16-8
	3/4	-1610-3-16-12
1 1/4	1	-2000-3-20-16
1 1/2	1	-2400-3-24-16
2	1	-3200-3-32-16

Tube OD, mm		Basic Ordering Number
T	Tx	
3	6	-3M0-3-3M-6M
8		-8M0-3-8M-6M
10		-10M0-3-10M-6M
12		-12M0-3-12M-6M
15	12	-15M0-3-15M-12M
16		-16M0-3-16M-12M
18		-18M0-3-18M-12M
22		-22M0-3-22M-12M
25		-25M0-3-25M-12M

Unions

Reducing Union

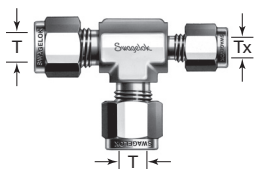

Tube OD, in.		Basic Ordering Number
T	Tx	
3/8	1/4	-600-3-4-6

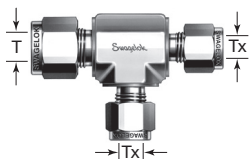

Tube OD, in.		Basic Ordering Number
T	Tx	
1/2	3/8	-810-3-6-6
5/8		-1010-3-6-6
3/4		-1210-3-6-6

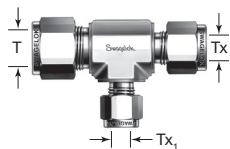

Tube OD, in.			Basic Ordering Number
T	Tx	Tx ₁	
5/8	1/2	3/8	-1010-3-8-6
3/4	1/2		-1210-3-8-6
1	3/4		-1610-3-12-6

Installation

Straight Fittings

Elbows and Tees

Adapters

Parts

Accessories

Male

Branch, NPT (TTM)



Tube OD in.	NPT Size in.	Basic Ordering Number
1/8	1/8 1/4	-200-3TTM -200-3-4TTM
3/16	1/8	-300-3TTM
1/4	1/8 1/4	-400-3TTM -400-3-4TTM
5/16	1/8	-500-3TTM
3/8	1/4 3/8	-600-3TTM -600-3-6TTM
1/2	3/8 1/2	-810-3TTM -810-3-8TTM
5/8	1/2	-1010-3TTM
3/4	3/4	-1210-3TTM

Tube OD mm	NPT Size in.	Basic Ordering Number
6	1/8 1/4	-6M0-3TTM -6M0-3-4TTM
8	1/8 1/4	-8M0-3TTM -8M0-3-4TTM
10	1/4	-10M0-3TTM
12	3/8 1/4 1/2	-12M0-3TTM -12M0-3-4TTM -12M0-3-8TTM
16	1/2	-16M0-3TTM

Male

Run, NPT (TMT)



Tube OD in.	NPT Size in.	Basic Ordering Number
1/8	1/8	-200-3TMT
	1/4	-200-3-4TMT
3/16	1/8	-300-3TMT
1/4	1/8	-400-3TMT
	1/4	-400-3-4TMT
5/16	1/8	-500-3TMT
3/8	1/4	-600-3TMT
	3/8	-600-3-6TMT
1/2	3/8	-810-3TMT
	1/2	-810-3-8TMT
5/8	1/2	-1010-3TMT
3/4	3/4	-1210-3TMT

Tube OD mm	NPT Size in.	Basic Ordering Number
6	1/8	-6M0-3TMT
	1/4	-6M0-3-4TMT
8	1/4	-8M0-3-4TMT
12	1/4	-12M0-3-4TMT
	1/2	-12M0-3-8TMT
16	1/2	-16M0-3TMT

Installation

Straight Fittings

Elbows and Tees

Adapters

Parts

Accessories

Male

**Positionable
Branch, SAE/MS
Straight Thread
(TTS)**

Tube OD in,	SAE/MS Thread Size	Basic Ordering Number
1/4	7/16-20	-400-3TTS
3/8	9/16-18	-600-3TTS
1/2	3/4-16	-810-3TTS
3/4	1 1/16-12	-1210-3TTS
1	1 5/16-12	-1610-3TTS
1 1/4	1 5/8-12	-2000-3TTS
1 1/2	1 7/8-12	-2400-3TTS
2	2 1/2-12	-3200-3TTS

**Positionable
Run,
SAE/MS Straight
Thread (TST)**

Tube OD in,	SAE/MS Thread Size	Basic Ordering Number
1/4	7/16-20	-400-3TST
3/8	9/16-18	-600-3TST
1/2	3/4-16	-810-3TST
3/4	1 1/16-12	-1210-3TST
1	1 5/16-12	-1610-3TST
1 1/4	1 5/8-12	-2000-3TST
1 1/2	1 7/8-12	-2400-3TST
2	2 1/2-12	-3200-3TST

Male

Positionable Branch, ISO/BSP Parallel Thread (TTR)



Tube OD in.	ISO Thread Size in.	Basic Ordering Number
1/4	1/8 1/4	-400-3TTR -400-3-4TTR
3/8	1/4	-600-3TTR
1/2	3/8 1/2	-810-3TTR -810-3-8TTR
5/8	1/2	-1010-3TTR
3/4	3/4 1/2	-1210-3TTR -1210-3-8TTR
1	1	-1610-3TTR

Tube OD mm	ISO Thread Size in.	Basic Ordering Number
6	1/8 1/4	-6M0-3TTR -6M0-3-4TTR
8	1/8 1/4	-8M0-3TTR -8M0-3-4TTR
10	1/4	-10M0-3TTR
12	3/8 1/2	-12M0-3TTR -12M0-3-8TTR

Installation

Straight Fittings

Elbows and Tees

Adapters

Parts

Accessories

Male

Positionable Run, ISO/BSP Parallel Thread (TRT)



Tube OD in.	ISO Thread Size in.	Basic Ordering Number
1/4	1/8 1/4	-400-3TRT -400-3-4TRT
3/8	1/4	-600-3TRT
1/2	3/8 1/2	-810-3TRT -810-3-8TRT
5/8	1/2	-1010-3TRT
3/4	3/4 1/2	-1210-3TRT -1210-3-8TRT
1	1	-1610-3TRT

Tube OD mm	ISO Thread Size in.	Basic Ordering Number
6	1/8 1/4	-6M0-3TRT -6M0-3-4TRT
8	1/8 1/4	-8M0-3TRT -8M0-3-4TRT
10	1/4	-10M0-3TRT
12	3/8 1/2	-12M0-3TRT -12M0-3-8TRT

Female

Run, NPT (TFT)



Tube OD in.	NPT Size in.	Basic Ordering Number
1/8	1/8	-200-3TFT
1/4	1/8 1/4	-400-3TFT -400-3-4TFT
3/8	1/4	-600-3TFT
1/2	3/8 1/2	-810-3TFT -810-3-8TFT
3/4	3/4	-1210-3TFT
1	3/4 1	-1610-3-12TFT -1610-3TFT

Tube OD mm	NPT Size in.	Basic Ordering Number
6	1/8 1/4	-6M0-3TFT -6M0-3-4TFT
8	1/8 1/4	-8M0-3TFT -8M0-3-4TFT
10	1/4	-10M0-3TFT
12	1/4 3/8 1/2	-12M0-3-4TFT -12M0-3TFT -12M0-3-8TFT
16	1/2	-16M0-3TFT

Installation

Straight Fittings

Elbows and Tees

Adapters

Parts

Accessories

Female

Branch, NPT (TTF)



Tube OD in.	NPT Size in.	Basic Ordering Number
1/8	1/8	-200-3TTF
1/4	1/8 1/4	-400-3TTF -400-3-4TTF
3/8	1/4 3/8 1/2	-600-3TTF -600-3-6TTF -600-3-8TTF
1/2	1/4 3/8 1/2	-810-3-4TTF -810-3TTF -810-3-8TTF
5/8	1/2	-1010-3TTF
3/4	3/4	-1210-3TTF
1	3/4 1	-1610-3-12TTF -1610-3TTF

Tube OD mm	NPT Size in.	Basic Ordering Number
6	1/8 1/4	-6M0-3TTF -6M0-3-4TTF
8	1/8 1/4	-8M0-3TTF -8M0-3-4TTF
10	1/4	-10M0-3TTF
12	1/4 3/8 1/2	-12M0-3-4TTF -12M0-3TTF -12M0-3-8TTF
16	1/2	-16M0-3TTF

Union

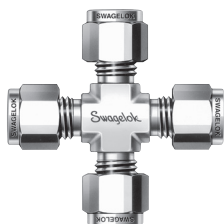

Tube OD in.	Basic Ordering Number
1/8	-200-4
1/4	-400-4
5/16	-500-4
3/8	-600-4
1/2	-810-4
3/4	-1210-4
1	-1610-4

Tube OD mm	Basic Ordering Number
3	-3M0-4
6	-6M0-4
8	-8M0-4
10	-10M0-4
12	-12M0-4
16	-16M0-4
18	-18M0-4
20	-20M0-4
22	-22M0-4
25	-25M0-4

Installation

Straight Fittings

Elbows and Tees

Adapters

Parts

Accessories

Kwik-Clamp Flange To Swagelok Tube Fitting

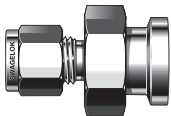

Tube OD in.	Flange Size in.	Ordering Number
1/4	1/2	SS-400-SC-8
	3/4	SS-400-SC-12
	1	SS-400-SC-16
	1 1/2	SS-400-SC-24
3/8	1/2	SS-600-SC-8
	3/4	SS-600-SC-12
	1	SS-600-SC-16
	1 1/2	SS-600-SC-24
1/2	1/2	SS-810-SC-8
	3/4	SS-810-SC-12
	1	SS-810-SC-16
	1 1/2	SS-810-SC-24
1	1	SS-1610-SC-16
	2	SS-1610-SC-32

Tube Adapters Male

NPT



1 in./25 mm and Under

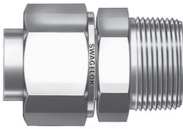

Over 1 in./25 mm

Tube OD in.	NPT Size in.	Basic Ordering Number
1/8	1/8	-2-TA-1-2
	1/4	-2-TA-1-4
3/16	1/8	-3-TA-1-2
	1/4	-3-TA-1-4
1/4	1/8	-4-TA-1-2
	1/4	-4-TA-1-4
	3/8	-4-TA-1-6
	1/2	-4-TA-1-8
5/16	1/8	-5-TA-1-2
	1/4	-5-TA-1-4
3/8	1/8	-6-TA-1-2
	1/4	-6-TA-1-4
	3/8	-6-TA-1-6
	1/2	-6-TA-1-8
1/2	1/4	-8-TA-1-4
	3/8	-8-TA-1-6
	1/2	-8-TA-1-8
5/8	1/2	-10-TA-1-8
3/4	1/2	-12-TA-1-8
	3/4	-12-TA-1-12
1	3/4	-16-TA-1-12
	1	-16-TA-1-16
1 1/4	1 1/4	-20-TA-1-20 ^①
1 1/2	1 1/2	-24-TA-1-24 ^①
2	2	-32-TA-1-32 ^①

⚠ Swagelok tube adapters are to be used ONLY in Swagelok tube fittings. Use in fittings made by other manufacturers may result in leakage or slippage.

Tube OD mm	NPT Size in.	Basic Ordering Number
6	1/8	-6-MTA-1-2
	1/4	-6-MTA-1-4
8	1/4	-8-MTA-1-4
	3/8	-8-MTA-1-6
10	1/4	-10-MTA-1-4
	3/8	-10-MTA-1-6
	1/2	-10-MTA-1-8
12	1/4	-12-MTA-1-4
	1/2	-12-MTA-1-8
28	1	-28-MTA-1-16 ^①
	1 1/4	-28-MTA-1-20 ^①
30	1	-30-MTA-1-16 ^①
	1 1/4	-30-MTA-1-20 ^①
32	1 1/4	-32-MTA-1-20 ^①
38	1 1/2	-38-MTA-1-24 ^①

^① Furnished with nut and preswaged ferrules.

Male

ISO/BSP Tapered Thread (RT)



1 in./25 mm and Under

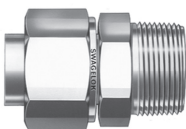

Over 1 in./25 mm

Tube OD in.	ISO Thread Size in.	Basic Ordering Number
1/8	1/8	-2-TA-1-2RT
	1/4	-2-TA-1-4RT
1/4	1/8	-4-TA-1-2RT
	1/4	-4-TA-1-4RT
3/8	1/4	-6-TA-1-4RT
	3/8	-6-TA-1-6RT
	1/2	-6-TA-1-8RT
1/2	1/4	-8-TA-1-4RT
	3/8	-8-TA-1-6RT
	1/2	-8-TA-1-8RT
3/4	3/4	-12-TA-1-12RT
1	1	-16-TA-1-16RT

Tube OD mm	ISO Thread Size in.	Basic Ordering Number
6	1/8	-6-MTA-1-2RT
	1/4	-6-MTA-1-4RT
8	1/4	-8-MTA-1-4RT
10	1/4	-10-MTA-1-4RT
	3/8	-10-MTA-1-6RT
12	1/4	-12-MTA-1-4RT
	3/8	-12-MTA-1-6RT
	1/2	-12-MTA-1-8RT
28	1	-28-MTA-1-16RT ^①
	1 1/4	-28-MTA-1-20RT ^①
30	1 1/4	-30-MTA-1-20RT ^①
32	1 1/4	-32-MTA-1-20RT ^①
38	1 1/2	-38-MTA-1-24RT ^①

① Furnished with nut and preswaged ferrules.

Male

ISO/BSP Parallel Thread (RS)



1 in./25 mm and Under



Over 1 in./25 mm

Tube OD in.	ISO Thread Size in.	Basic Ordering Number
1/8	1/8	-2-TA-1-2RS
	1/4	-2-TA-1-4RS
1/4	1/8	-4-TA-1-2RS
	1/4	-4-TA-1-4RS
3/8	1/4	-6-TA-1-4RS
	3/8	-6-TA-1-6RS
1/2	1/4	-8-TA-1-4RS
	3/8	-8-TA-1-6RS
	1/2	-8-TA-1-8RS
3/4	3/4	-12-TA-1-12RS
1	1	-16-TA-1-16RS

Tube OD mm	ISO Thread Size in.	Basic Ordering Number
6	1/8	-6-MTA-1-2RS
	1/4	-6-MTA-1-4RS
8	1/4	-8-MTA-1-4RS
10	1/4	-10-MTA-1-4RS
	3/8	-10-MTA-1-6RS
	1/2	-10-MTA-1-8RS
12	1/4	-12-MTA-1-4RS
	3/8	-12-MTA-1-6RS
	1/2	-12-MTA-1-8RS
18	1/2	-18-MTA-1-8RS
	3/4	-18-MTA-1-12RS
28	1	-28-MTA-1-16RS ^①
	1 1/4	-28-MTA-1-20RS ^①
30	1 1/4	-30-MTA-1-20RS ^①
32	1 1/4	-32-MTA-1-20RS ^①
38	1 1/2	-38-MTA-1-24RS ^①

① Furnished with nut and preswaged ferrules.

Installation

Straight Fittings

Elbows and Tees

Adapters

Parts

Accessories

Male

ISO/BSP Parallel Thread (RP)

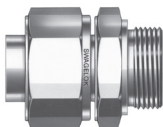

Tube OD mm	ISO Thread Size in.	Basic Ordering Number
28	1 1 1/4	-28-MTA-1-16RP ^① -28-MTA-1-20RP ^①
30	1 1/4	-30-MTA-1-20RP ^①
32	1 1/4	-32-MTA-1-20RP ^①
38	1 1/2	-38-MTA-1-24RP ^①

^① Furnished with nut and preswaged ferrules.

SAE/MS Straight Thread (ST)



1 in./25 mm and Under



Over 1 in./25 mm

Tube OD in.	SAE/MS Thread Size	Basic Ordering Number
1/8	5/16-24	-2-TA-1-2ST
1/4	7/16-20	-4-TA-1-4ST
3/8	7/16-20 9/16-18 3/4-16	-6-TA-1-4ST -6-TA-1-6ST -6-TA-1-8ST
1/2	9/16-18 3/4-16	-8-TA-1-6ST -8-TA-1-8ST
5/8	7/8-14	-10-TA-1-10ST
3/4	1 1/16-12	-12-TA-1-12ST
1	1 5/16-12	-16-TA-1-16ST
1 1/4	1 5/8-12	-20-TA-1-20ST ^①
1 1/2	1 7/8-12	-24-TA-1-24ST ^①
2	2 1/2-12	-32-TA-1-32ST ^①

^① Furnished with nut and preswaged ferrules.

Male

O-Seal (SAE/MS Straight Thread)



Tube OD in.	SAE/MS Thread Size	Basic Ordering Number
1/8	5/16-24	-2-TA-1-OR
3/16	3/8-24	-3-TA-1-OR
1/4	7/16-20	-4-TA-1-OR
5/16	1/2-20	-5-TA-1-OR
3/8	9/16-18	-6-TA-1-OR
1/2	3/4-16	-8-TA-1-OR

AN Thread



Tube OD in.	AN Tube Flare Size in.	Thread Size	Basic Ordering Number
1/4	1/4	7/16-20UNJF-3	-4-TA-1-4AN
3/8	1/4 3/8	7/16-20UNJF-3 9/16-18UNJF-3	-6-TA-1-4AN -6-TA-1-6AN
1/2	1/2	3/4-16UNJF-3	-8-TA-1-8AN
3/4	3/4	1 1/16-12UNJ-3	-12-TA-1-12AN
1	1	1 5/16-12UNJ-3	-16-TA-1-16AN

Pipe Weld



Tube OD in.	Pipe Weld Size in.	Basic Ordering Number
1/4	1/4	-4-TA-1-4W
3/8	1/2	-6-TA-1-8W
1/2	1/2 3/4	-8-TA-1-8W -8-TA-1-12W
3/4	3/4	-12-TA-1-12W

Installation

Straight Fittings

Elbows and Tees

Adapters

Parts

Accessories

Female

NPT



1 in./25 mm and Under

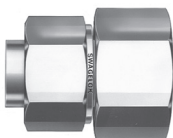

Over 1 in./25 mm

Tube OD in.	NPT Size in.	Basic Ordering Number
1/8	1/8	-2-TA-7-2
	1/4	-2-TA-7-4
3/16	1/4	-3-TA-7-4
1/4	1/8	-4-TA-7-2
	1/4	-4-TA-7-4
	3/8	-4-TA-7-6
	1/2	-4-TA-7-8
5/16	1/4	-5-TA-7-4
3/8	1/8	-6-TA-7-2
	1/4	-6-TA-7-4
	3/8	-6-TA-7-6
	1/2	-6-TA-7-8
1/2	1/4	-8-TA-7-4
	3/8	-8-TA-7-6
	1/2	-8-TA-7-8
5/8	1/2	-10-TA-7-8
3/4	1/2	-12-TA-7-8
	3/4	-12-TA-7-12
	1	-12-TA-7-16
1	3/4	-16-TA-7-12
	1	-16-TA-7-16
1 1/4	1 1/4	-20-TA-7-20 ^①
1 1/2	1 1/2	-24-TA-7-24 ^①
2	2	-32-TA-7-32 ^①

① Furnished with nut and preswaged ferrules.

Tube OD mm	NPT Size in.	Basic Ordering Number
6	1/8	-6-MTA-7-2
	1/4	-6-MTA-7-4
8	1/4	-8-MTA-7-4
10	1/4	-10-MTA-7-4
	3/8	-10-MTA-7-6
	1/2	-10-MTA-7-8
12	1/4	-12-MTA-7-4
	1/2	-12-MTA-7-8

Female

ISO/BSP Tapered Thread (RT)



Tube OD in.	ISO Thread Size in.	Basic Ordering Number
1/4	1/8 1/4	-4-TA-7-2RT -4-TA-7-4RT
3/8	1/4 3/8	-6-TA-7-4RT -6-TA-7-6RT
1/2	1/4 3/8 1/2	-8-TA-7-4RT -8-TA-7-6RT -8-TA-7-8RT

Tube OD mm	ISO Thread Size in.	Basic Ordering Number
6	1/8	-6-MTA-7-2RT
8	1/4	-8-MTA-7-4RT
10	1/4	-10-MTA-7-4RT

ISO/BSP Parallel Thread (RP)

Tube OD in.	ISO Thread Size in.	Basic Ordering Number
1/8	1/8	-2-TA-7-2RP
1/4	1/8 1/4	-4-TA-7-2RP -4-TA-7-4RP
3/8	1/4 3/8	-6-TA-7-4RP -6-TA-7-6RP
1/2	3/8 1/2	-8-TA-7-6RP -8-TA-7-8RP

Tube OD mm	ISO Thread Size in.	Basic Ordering Number
6	1/8 1/4	-6-MTA-7-2RP -6-MTA-7-4RP
12	1/2	-12-MTA-7-8RP

Installation

Straight Fittings

Elbows and Tees

Adapters

Parts

Accessories

Female

ISO/BSP Parallel Thread (RG, Gauge)



Tube OD in.	ISO Thread Size in.	Basic Ordering Number
1/4	1/4	-4-TA-7-4RG
3/8	3/8	-6-TA-7-6RG
1/2	1/2	-8-TA-7-8RG

Tube OD mm	ISO Thread Size in.	Basic Ordering Number
6	1/4	-6-MTA-7-4RG
	3/8	-6-MTA-7-6RG
	1/2	-6-MTA-7-8RG
8	1/4	-8-MTA-7-4RG
	3/8	-8-MTA-7-6RG
	1/2	-8-MTA-7-8RG
10	1/4	-10-MTA-7-4RG
	3/8	-10-MTA-7-6RG
	1/2	-10-MTA-7-8RG
12	1/4	-12-MTA-7-4RG
	3/8	-12-MTA-7-6RG
	1/2	-12-MTA-7-8RG
16	1/2	-16-MTA-7-8RG
18	1/2	-18-MTA-7-8RG

Female

ISO/BSP Parallel Thread (RJ)



ISO/BSP parallel thread (RJ) fittings are available in stainless steel only.

Tube OD in.	ISO Thread Size in.	Ordering Number
1/4	1/4	SS-4-TA-7-4RJ
3/8	3/8	SS-6-TA-7-6RJ
1/2	1/2	SS-8-TA-7-8RJ

Tube OD mm	ISO Thread Size in.	Ordering Number
6	1/4	SS-6-MTA-7-4RJ
	3/8	SS-6-MTA-7-6RJ
	1/2	SS-6-MTA-7-8RJ
8	1/4	SS-8-MTA-7-4RJ
	3/8	SS-8-MTA-7-6RJ
	1/2	SS-8-MTA-7-8RJ
10	1/4	SS-10-MTA-7-4RJ
	3/8	SS-10-MTA-7-6RJ
	1/2	SS-10-MTA-7-8RJ
12	1/4	SS-12-MTA-7-4RJ
	3/8	SS-12-MTA-7-6RJ
	1/2	SS-12-MTA-7-8RJ

AN Thread



Tube OD in.	AN Tube Flare Size in.	Basic Ordering Number
1/8	1/8	-200-A-2ANF
	1/4	-200-A-4ANF
1/4	1/4	-400-A-4ANF
3/8	3/8	-600-A-6ANF
1/2	1/2	-810-A-8ANF
3/4	3/4	-1210-A-12ANF

Installation

Straight Fittings

Elbows and Tees

Adapters

Parts

Accessories

Tube Fitting Part Numbers

Swagelok tube fitting part numbers follow the sequence shown below.

Installation

A - **B** **C** **D** - **E** - **F** **G**
SS - **2** **0** **0** - **1** - **2** **RT**

Straight Fittings

A Material

- A = Aluminum
- B = Brass
- HC = Alloy C-276
- INC = Alloy 600
- M = Alloy 400
- S = Carbon steel
- SS = 316 stainless steel
- 6ELT = High-temperature
316 stainless steel
- T = PTFE
- TI = Titanium
- 6MO = 6-Moly
- 625 = Alloy 625
- 825 = Alloy 825
- 2507 = Alloy 2507

Elbows and Tees

Adapters

B Size (Tube OD)

Fractional, in.	Metric, mm
1 = 1/16	2 = 2
2 = 1/8	3 = 3
3 = 3/16	4 = 4
4 = 1/4	6 = 6
5 = 5/16	8 = 8
6 = 3/8	10 = 10
8 = 1/2	12 = 12
10 = 5/8	14 = 14
12 = 3/4	15 = 15
14 = 7/8	16 = 16
16 = 1	18 = 18
18 = 1 1/8	20 = 20
20 = 1 1/4	22 = 22
24 = 1 1/2	25 = 25
32 = 2	28 = 28
	32 = 32
	38 = 38
	50 = 50

Accessories

Parts

A - **B** **C** **D** - **E** - **F** **G**
SS - **2** **0** **0** - **1** - **2** **RT**

C Series

- 0** = Fractional 1/16 to 3/8 in. and 1 1/4 to 2 in.
- 1** = Fractional 1/2 to 1 1/8 in.
- 3** = HC 3/4 in. and 1 in. with advanced geometry ferrules
- M** = Millimeter tube size

To order a female Swagelok tube fitting, add **F**.

Example: SS-100**F**-1-1.

D Component

- 0** = Fitting
- 1** = Body

E Fitting Type

- 1** = Male connector
- 2** = 90° male elbow
- 3** = Tee, union
- 4** = Cross, union
- 5** = 45° male elbow
- 6** = Union
- 7** = Female connector
- 8** = Female elbow
- 9** = Elbow, union
- 11** = Bulkhead male connector
- 61** = Bulkhead union
- 71** = Bulkhead female connector
- A** = Adapter
- C** = Cap
- P** = Plug
- PC** = Port connector
- R** = Reducer
- R1** = Bulkhead reducer
- 2R** = Reducing elbow
- TFT** = Tee, female run
- TMT** = Tee, male run
- TRT** = Tee, ISO/BSP parallel male positionable run
- TST** = Tee, straight thread with O-ring male positionable run
- TTF** = Tee, female branch
- TTM** = Tee, male branch
- TTR** = Tee, ISO/BSP parallel male positionable branch
- TTS** = Tee, straight thread with O-ring male positionable branch

Installation

Straight Fittings

Elbows and Tees

Adapters

Parts

Accessories

A - **B** **C** **D** - **E** - **F** **G**
SS - **2** **0** **0** - **1** - **2** **RT**

F Second End Connection Size

Add a size designator from the list on page 106 for the second end connection or if the fitting is a reducing union.

G Second End Connection Type

Add a second end connection type designator as needed.

AN = 37° male AN flare

ANF = 37° female AN flare

BT = Bored-through fitting

F = Female thread

KN = Knurled nut, nylon ferrules

KT = Knurled nut, PTFE ferrules

M = Metric tube end

OR = O-seal connection

PR = ISO/BSP positionable parallel pipe thread

RG = ISO/BSP parallel pipe thread (gauge)

RJ = ISO/BSP parallel pipe thread
(Japanese gauge)

RP = ISO/BSP parallel pipe thread

RS = ISO/BSP parallel pipe thread

RT = ISO/BSP tapered pipe thread

ST = Straight thread with O-ring (for SAE/MS)

W = Male pipe weld/tube socket weld

Tees and Crosses

Ordering numbers for tees and crosses indicate first the size of the run (**1** to **2**) and then the size of the branch (**3** for tees and **3** to **4** for crosses).

Example: SS-6M0-3-4TTF for a 316 SS female tee for 6 mm tube with 1/4 in. female NPT branch

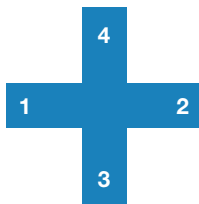

Tube Adapter Part Numbers

Swagelok tube adapter part numbers follow the sequence shown below.

A - **B** - **C** - **D** - **E** **F**
SS - **2** - **TA** - **1** - **4** **RT**

A Material

- A** = Aluminum
- B** = Brass
- HC** = Alloy C-276
- INC** = Alloy 600
- M** = Alloy 400
- S** = Steel
- SS** = Stainless steel
- 6ELT** = High-temperature
316 stainless steel
- T** = PTFE
- TI** = Titanium
- 6MO** = 6-Moly
- 625** = Alloy 625
- 825** = Alloy 825
- 2507** = Alloy 2507

B Size (Tube OD)

Fractional, in.	Metric, mm
1 = 1/16	2 = 2
2 = 1/8	3 = 3
3 = 3/16	4 = 4
4 = 1/4	6 = 6
5 = 5/16	8 = 8
6 = 3/8	10 = 10
8 = 1/2	12 = 12
10 = 5/8	14 = 14
12 = 3/4	15 = 15
14 = 7/8	16 = 16
16 = 1	18 = 18
18 = 1 1/8	20 = 20
20 = 1 1/4	22 = 22
24 = 1 1/2	25 = 25
32 = 2	28 = 28
	32 = 32
	38 = 38
	50 = 50

Installation

Straight Fittings

Elbows and Tees

Adapters

Parts

Accessories

A - **B** - **C** - **D** - **E** **F**
SS - **2** - **TA** - **1** - **4** **RT**

C Component

TA = Fractional tube adapter

MTA = Metric tube adapter

D Adapter Type

1 = Male adapter

7 = Female adapter

E Second End Connection Size

Add a size designator from the list on page 109 for the second end connection.

F Second End Connection Type

Add a second end connection type designator as needed.

AN = 37° male AN flare

ANF = 37° female AN flare

RG = ISO/BSP parallel pipe thread (gauge)

RJ = ISO/BSP parallel pipe thread
(Japanese gauge)

RP = ISO/BSP parallel pipe thread

RS = ISO/BSP parallel pipe thread

RT = ISO/BSP tapered pipe thread

ST = Straight thread with O-ring (for SAE/MS)

W = Male pipe weld/tube socket weld

Nuts



Female

Tube OD in.	Basic Ordering Number
1/16	-102-1
1/8	-202-1
3/16	-302-1
1/4	-402-1
5/16	-502-1
3/8	-602-1
1/2	-812-1
5/8	-1012-1
3/4	-1212-1
7/8	-1412-1
1	-1612-1
1 1/4	-2002-1
1 1/2	-2402-1
2	-3202-1

Tube OD mm	Basic Ordering Number
2	-2M2-1
3	-3M2-1
4	-4M2-1
6	-6M2-1
8	-8M2-1
10	-10M2-1
12	-12M2-1
14	-14M2-1
15	-15M2-1
16	-16M2-1
18	-18M2-1
20	-20M2-1
22	-22M2-1
25	-25M2-1
28	-28M2-1
30	-30M2-1
32	-32M2-1
38	-38M2-1
50	-50M2-1

Installation

Straight Fittings

Elbows and Tees

Adapters

Parts

Accessories

Nuts



Knurled Female

The Swagelok knurled nut tube fitting provides a leak-tight seal without the use of inserts on most wall thicknesses of polyethylene tubing. Inserts may be required for larger sizes.

To set the ferrules on the tubing, initial connections must be made with a wrench, tightening the nut one and one-quarter turns from finger-tight (three-quarters turn for 1/16, 1/8 and 3/16 in.; 2, 3, and 4 mm fittings). Leak-tight connections may be reassembled with finger-tight assembly.

To order a knurled nut, add **K** to the female nut basic ordering number.

Example: B-402-1**K**

To order a knurled nut on an assembled fitting with nylon ferrules, add **KN** to the fitting ordering number.

Example: SS-400-1-2**KN**

To order a knurled nut on an assembled fitting with PTFE ferrules, add **KT** to the fitting ordering number.

Example: SS-400-1-2**KT**

Male

For use in female Swagelok end connections.



Tube OD in.	Basic Ordering Number
1/16	-1F2-1GC
1/8	-2F2-1GC
1/4	-4F2-1
1/2	-8F2-1

Tube OD mm	Basic Ordering Number
10	-10MF2-1
12	-12MF2-1

Ferrules



Front

Tube OD in.	Basic Ordering Number
1/16	-103-1
1/8	-203-1
3/16	-303-1
1/4	-403-1
5/16	-503-1
3/8	-603-1
1/2	-813-1
5/8	-1013-1
3/4	-1213-1
7/8	-1413-1
1	-1613-1
1 1/4	-2003-1 ^①
1 1/2	-2403-1 ^①
2	-3203-1 ^①

① Over 1 in. and over 25 mm stainless steel front ferrules are PFA coated. To order silver-plated front ferrules, add **-BL** to the basic ordering number.

Example:
SS-2003-1-**BL**

Tube OD mm	Basic Ordering Number
2	-2M3-1
3	-3M3-1
4	-4M3-1
6	-6M3-1
8	-8M3-1
10	-10M3-1
12	-12M3-1
14	-14M3-1
15	-15M3-1
16	-16M3-1
18	-18M3-1
20	-20M3-1
22	-22M3-1
25	-25M3-1
28	-28M3-1 ^①
30	-30M3-1 ^①
32	-32M3-1 ^①
38	-38M3-1 ^①
50	-50M3-1 ^①

Installation

Straight Fittings

Elbows and Tees

Adapters

Parts

Accessories

Ferrules



Back

Tube OD in.	Basic Ordering Number
1/16	-104-1
1/8	-204-1
3/16	-304-1
1/4	-404-1
5/16	-504-1
3/8	-604-1
1/2	-814-1
5/8	-1014-1
3/4	-1214-1
7/8	-1414-1
1	-1614-1
1 1/4	-2004-1 ^①
1 1/2	-2404-1 ^①
2	-3204-1 ^①

① Over 1 in. and over 25 mm stainless steel back ferrules are PFA coated. To order back ferrules without PFA coating, add **-WC** to the basic ordering number.

Example:

SS-2004-1-**WC**

Tube OD mm	Basic Ordering Number
2	-2M4-1
3	-3M4-1
4	-4M4-1
6	-6M4-1
8	-8M4-1
10	-10M4-1
12	-12M4-1
14	-14M4-1
15	-15M4-1
16	-16M4-1
18	-18M4-1
20	-20M4-1
22	-22M4-1
25	-25M4-1
28	-28M4-1 ^①
30	-30M4-1 ^①
32	-32M4-1 ^①
38	-38M4-1 ^①
50	-50M4-1 ^①

Nut-Ferrule Sets and Nut-Ferrule Packages

Nut-Ferrule Set

The nut-ferrule set contains one nut, one back ferrule, and one front ferrule.

To order, add a material designator to the basic ordering number. Please order nut-ferrule sets in multiples of five.

Example: **SS-400-NFSET**

Material	Designator
Brass	B
Carbon steel	S
316 stainless steel	SS

Tube OD in.	Basic Ordering Number
1/4	-400-NFSET
3/8	-600-NFSET
1/2	-810-NFSET

Tube OD mm	Basic Ordering Number
6	-6M0-NFSET
8	-8M0-NFSET
10	-10M0-NFSET
12	-12M0-NFSET

Nut-Ferrule Package

To order the nut-ferrule package (50 nut-ferrule sets), contact your authorized Swagelok sales and service center.



Ferrule Sets and Ferrule-Paks

Ferrule Set

The ferrule set contains one front ferrule and one back ferrule.

To order, add a material designator to the basic ordering number. Please order ferrule sets in multiples of ten.

Example: **SS-100-SET**

Material	Designator
Alloy 400	M
Aluminum	A
Brass	B
Carbon steel	S
Nylon	NY
PTFE	T
316 stainless steel	SS

Tube OD in.	Basic Ordering Number
1/16	-100-SET
1/8	-200-SET
3/16	-300-SET
1/4	-400-SET
5/16	-500-SET
3/8	-600-SET
1/2	-810-SET

Tube OD mm	Basic Ordering Number
6	-6M0-SET
8	-8M0-SET
10	-10M0-SET
12	-12M0-SET

Ferrule-Pak

To order the ferrule-pak package (100 front and back sets), contact your authorized Swagelok sales and service center.

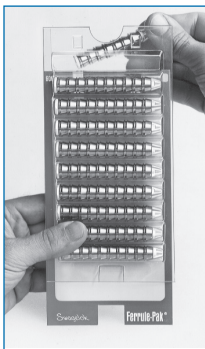

ISO/BSP Parallel Gaskets



**RS/RSD
Gasket**



**RSNB
Gasket**

Steel and Stainless Steel (RS Fitting)

RS fitting steel gaskets provide a seal with male ISO/BSP parallel threads.

The RS gasket is of a fluorocarbon FKM inner ring bonded to a carbon steel outer ring.

The RSD (DIN-style) gasket is a fluorocarbon FKM inner ring bonded to a stainless steel or carbon steel outer ring as recommended in ISO 1179-1973. It can be used with end connections designed in accordance with DIN 3852 Part 2.

The RSNB gasket is an all-metal 304L stainless steel gasket similar to DIN 7603 form D.

ISO Thread Size, in.	Ordering Number		
	RS Gasket ^①	RSD Gasket ^②	RSNB Gasket
1/8	S-2-RS-2V	SS-2-RSD-2V	304L-2-RSNB-2
1/4	S-4-RS-2V ^③	SS-4-RSD-2V	304L-4-RSNB-2
3/8	S-6-RS-2V ^③	SS-6-RSD-2V	304L-6-RSNB-2
1/2	S-8-RS-2V ^③	SS-8-RSD-2V	304L-8-RSNB-2
3/4	S-12-RS-2V	SS-12-RSD-2V	304L-12-RSNB-2
1	S-16-RS-2V	SS-16-RSD-2V	304L-16-RSNB-2
1 1/4	S-20-RS-2V	SS-20-RSD-2V	304L-20-RSNB-2
1 1/2	S-24-RS-2V	SS-24-RSD-2V	304L-24-RSNB-2

① Also available with a Buna inner ring. To order, replace **V** with **B** in the ordering number.

Example: S-2-RS-2**B**

② Also available with a carbon steel outer ring. To order, replace **SS** with **S** in the ordering number.

Example: **S**-8-RSD-2V

③ Also available with a stainless steel outer ring. To order, replace **S** with **SS** in the ordering number.

Example: **SS**-8-RS-2V

ISO/BSP Parallel Gaskets



Copper (RP and RS Fitting)

The RP and RS fitting copper gasket provides a seal with male ISO/BSP parallel threads.

ISO Thread Size, in.	Ordering Number
1/8	CU-2-RP-2
1/4	CU-4-RP-2
3/8	CU-6-RP-2
1/2	CU-8-RP-2
3/4	CU-12-RP-2
1	CU-16-RP-2
1 1/4	CU-20-RP-2
1 1/2	CU-24-RP-2



Copper and Nickel (RG, Gauge Fitting)

The RG fitting gasket provides a seal on pressure gauges equipped with ISO/BSP parallel male threads.

ISO Thread Size, in.	Ordering Number
Copper Gaskets	
1/4	CU-4-RG-2
3/8	CU-6-RG-2
1/2	CU-8-RG-2
Nickel Gaskets	
1/4	NI-4-RG-2
3/8	NI-6-RG-2
1/2	NI-8-RG-2



PTFE (RJ Fitting)

The RJ fitting PTFE gasket provides a seal with ISO/BSP parallel male threads.

ISO Thread Size, in.	Ordering Number
Regular Gaskets	
1/4	T-4-RJ-2
3/8	T-6-RJ-2
1/2	T-8-RJ-2
Thick Gaskets	
1/4	T-4-RJ-2-T
3/8	T-6-RJ-2-T
1/2	T-8-RJ-2-T

O-Rings

Buna N (O-Seal Straight Threads)

O-ring
hardness is 70
durometer.

Thread Size in.	Uniform Size Number	Ordering Number
5/16-24	011	BN-70-OR-011
3/8-24	012	BN-70-OR-012
7/16-20	013	BN-70-OR-013
1/2-20	112	BN-70-OR-112
9/16-18	113	BN-70-OR-113
3/4-16	116	BN-70-OR-116
1 1/16-12	121	BN-70-OR-121
1 5/16-12	125	BN-70-OR-125

Buna N (O-Seal Pipe Threads)

O-ring
hardness is 70
durometer.

NPT/ISO Pipe Size in.	Uniform Size Number	Ordering Number
1/8	013	BN-70-OR-013
1/4	113	BN-70-OR-113
3/8	116	BN-70-OR-116
1/2	118	BN-70-OR-118

Installation

Straight Fittings

Elbows and Tees

Adapters

Parts

Accessories

O-Rings

Fluorocarbon FKM (Positionable Fittings, ISO/BSP Parallel Threads)

O-ring hardness is 90 durometer.

ISO Thread Size in.	Uniform Size Number	Ordering Number
1/8	502 ^①	FSP-90-OR-502
1/4	111	FCBR-90-OR-111
3/8	113	FCBR-90-OR-113
1/2	508 ^①	FCBR-90-OR-508
3/4	119	FCBR-90-OR-119
1	217	FCBR-90-OR-217

① Not a uniform O-ring size.

Fluorocarbon FKM (SAE/MS Straight Threads)

O-ring hardness is 90 durometer.

SAE/MS Thread Size	Uniform Size Number	Ordering Number
5/16-24	902	FCBR-90-OR-902
3/8-24	903	FCBR-90-OR-903
7/16-20	904	FCBR-90-OR-904
1/2-20	905	FCBR-90-OR-905
9/16-18	906	FCBR-90-OR-906
3/4-16	908	FCBR-90-OR-908
7/8-14	910	FCBR-90-OR-910
1 1/16-12	912	FCBR-90-OR-912
1 3/16-12	914	FCBR-90-OR-914
1 5/16-12	916	FCBR-90-OR-916
1 5/8-12	920	FCBR-90-OR-920
1 7/8-12	924	FCBR-90-OR-924
2 1/2-12	932	FCBR-90-OR-932

Bulkhead Retainers

The bulkhead retainer acts as a backup wrench, enabling one person with one wrench to install a bulkhead fitting.



Fitting Size		Ordering Number
in.	mm	
1/16	—	SS-102-61F
1/8	—	SS-202-61F
3/16	3, 4	SS-302-61F
1/4	6	SS-402-61F
5/16	—	SS-502-61F
—	8	SS-8M2-61F
3/8	—	SS-602-61F
—	10	SS-10M2-61F
1/2	12	SS-812-61F
5/8	15, 16	SS-1012-61F
3/4	18	SS-1212-61F
7/8	—	SS-1412-61F
1	—	SS-1612-61F

Installation

Straight Fittings

Elbows and Tees

Adapters

Parts

Accessories

Gap Inspection Gauges



Swagelok gap inspection gauges assure the installer or inspector that the fitting has been sufficiently pulled up on initial installation, whether using a multihead hydraulic swaging unit (MHSU) or air-actuated hydraulic swaging unit (AHSU), or wrench tightening. All metal Swagelok tube fittings are gaugeable, with the exception of a few forged bodies in aluminum.

For Installation Using a Wrench

Fitting Size		Ordering Number
in.	mm	
Female Nut		
1/16	—	MS-IG-100
1/8	2, 3	MS-IG-200
3/16	4	MS-IG-300
1/4	6	MS-IG-400
1/4, 3/8, 1/2	6, 12	MS-IG-468
1/4, 1/2	6, 8, 10, 12	MS-IG-612M
5/16	8	MS-IG-500
3/8	—	MS-IG-600
—	10	MS-IG-10M0
1/2	12	MS-IG-810
5/8	14, 15, 16	MS-IG-1010
5/8 (alloy 2507)	—	MS-IG-2507-1010
3/4	18	MS-IG-1210
3/4 (alloy 2507)	—	MS-IG-2507-1210
7/8	20, 22	MS-IG-1410
1	25	MS-IG-1610
Male Nut		
1/16	—	MS-IG-1F0
1/8	2, 3	MS-IG-2F0

Gap Inspection Gauges

For Installation Using the AHSU

Fitting Size		Ordering Number
in.	mm	
Female Nut		
1/4, 3/8, 1/2	—	MS-AHSU-IG-468
—	6, 8, 10, 12	MS-AHSU-IG-612M

For Installation Using the MHSU

Fitting Size		Ordering Number
in.	mm	
Female Nut		
1/2 ^①	12	MS-MHSU-IG-810
5/8 ^②	14, 15, 16	MS-MHSU-IG-1010
5/8 (alloy 2507)	—	MS-MHSU-IG-2507-1010
3/4 ^②	18	MS-MHSU-IG-1210
3/4 (alloy 2507)	—	MS-MHSU-IG-2507-1210
7/8	20, 22	MS-MHSU-IG-1410
1	25	MS-MHSU-IG-1610-1
—	28	MS-MHSU-IG-28M0-1
	30	MS-MHSU-IG-30M0-1
1 1/4	—	MS-MHSU-IG-2000-2
—	32	MS-MHSU-IG-32M0-1
—	38	MS-MHSU-IG-38M0-1
1 1/2	—	MS-MHSU-IG-2400-1
—	50	MS-MHSU-IG-50M0-1
2	—	MS-MHSU-IG-3200-1

① The MHSU cannot be used for alloy 2507 tubing 1/2 in. and under.

② For 5/8 and 3/4 in. alloy 2507 tubing, order the 1 in. (25 mm) and over unit and alloy 2507 tooling and gauge.

Depth Marking Tools

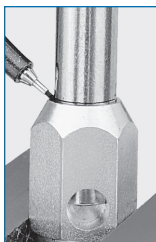

Swagelok depth marking tools help ensure that tubing is bottomed on the shoulder inside the Swagelok tube fitting body.

Tube OD in.	Ordering Number
1/4	MS-DMT-400
3/8	MS-DMT-600
1/2	MS-DMT-810
5/8	MS-DMT-1010
3/4	MS-DMT-1210
7/8	MS-DMT-1410
1	MS-DMT-1610

Tube OD mm	Ordering Number
6	MS-DMT-6M0
8	MS-DMT-8M0
10	MS-DMT-10M0
12	MS-DMT-12M0
16	MS-DMT-16M0
18	MS-DMT-18M0

Preswaging Tools

For Swagelok tube fitting installations in close quarters, the Swagelok preswaging tool is a convenient accessory.

A gaugeable preswaging tool is available in the following sizes: 1/4, 3/8, 1/2, and 5/8 inch and 6, 8, 10, 12, and 16 mm. All other sizes are not gaugeable. The gaugeable feature allows the installer to quickly measure the gap between the nut and the fitting body with a standard Swagelok gap gauge during initial installation. The gaugeable preswage tool is distinguished from the standard tool by the addition of a colored band located between the wrench pad and the Swagelok tube fitting end.



Tube OD in.	Ordering Number
Female Nut	
1/16	MS-ST-100
1/8	MS-ST-200
3/16	MS-ST-300
1/4 ^②	MS-ST-400GA
5/16	MS-ST-500
3/8 ^②	MS-ST-600GA
1/2 ^②	MS-ST-810GA
5/8 ^{①②}	MS-ST-1010GA
5/8 (alloy 2507)	MS-ST-2507-1010
3/4 ^①	MS-ST-1210
3/4 (alloy 2507)	MS-ST-2507-1210
7/8	MS-ST-1410
1	MS-ST-1610
Male Nut	
1/16	MS-ST-1F0
1/2	MS-ST-8F0

Tube OD mm	Ordering Number
Female Nut	
3	MS-ST-3M0
4	MS-ST-4M0
6 ^①	MS-ST-6M0GA
8 ^①	MS-ST-8M0GA
10 ^①	MS-ST-10M0GA
12 ^①	MS-ST-12M0GA
14	MS-ST-14M0
15	MS-ST-15M0
16 ^①	MS-ST-16M0GA
18	MS-ST-18M0
20	MS-ST-20M0
22	MS-ST-22M0
25	MS-ST-25M0

① Ordering numbers containing **GA** at the end are gaugeable preswage tools, all others are non-gaugeable preswage tools.

- ① For alloy 2507 tubing, use the preswaging tool for the appropriate tube OD and with 2507 in the ordering number.
- ② Ordering numbers containing **GA** at the end are gaugeable preswage tools, all others are non-gaugeable preswage tools.

Inserts for Soft Plastic Tubing

Swagelok inserts help secure soft plastic tubing being used with standard Swagelok tube fittings.



To determine the correct size of the Swagelok insert to be used, check both outside diameter and inside diameter of the plastic tubing.

Add the insert material designator to the basic ordering number.

Example:
B-305-2

For a complete line of hose connectors for soft plastic tubing, refer to Swagelok *Hose and Flexible Tubing* catalog, [MS-01-180](#).

Material	Designator
Alloy 400	M
Aluminum	A
Brass	B
Carbon steel	S
Stainless steel	SS

Tube OD in.	Tube ID in.	Bore ID in.	Basic Ordering Number
3/16	1/8	0.09	-305-2
1/4	1/8	0.09	-405-2
	0.17	0.11	-405-170
	3/16	0.14	-405-3
5/16	1/8	0.09	-505-2
	3/16	0.12	-505-3
	1/4	0.19	-505-4
3/8	3/16	0.12	-605-3
	1/4	0.19	-605-4
1/2	1/4	0.19	-815-4
	3/8	0.31	-815-6
5/8	3/8	0.31	-1015-6
	1/2	0.44	-1015-8
3/4	1/2	0.44	-1215-8
	5/8	0.56	-1215-10
1	3/4	0.69	-1615-12

Tube OD mm	Tube ID mm	Bore ID mm	Basic Ordering Number
6	4	2.8	-6M5-4M
8	6	4.4	-8M5-6M
10	8	6.4	-10M5-8M
12	8	6.4	-12M5-8M
	10	8.3	-12M5-10M

For product technical data, see the Swagelok *Gaugeable Tube Fittings and Adapters* catalog, [MS-01-140](#).

Safe Product Selection

When selecting a product, the total system design must be considered to ensure safe, trouble-free performance. Function, material compatibility, adequate ratings, proper installation, operation, and maintenance are the responsibilities of the system designer and user. The complete catalog contents must be reviewed to ensure that the system designer and user make a safe product selection.

WARNING

Do not mix/interchange Swagelok products or components not governed by industrial design standards, including Swagelok tube fitting end connections, with those of other manufacturers.

Warranty Information

Swagelok products are backed by The Swagelok Limited Lifetime Warranty, [MS-13-123](#). For a copy, visit [swagelok.com](#) or contact your authorized Swagelok sales and service center.



Swagelok, Ferrule-Pak, Goop, Swak—
TM Swagelok Company
© 2006–2023 Swagelok Company
Printed in U.S.A., AGS
June 2023, RevN
MS-13-151