

# THE APPLICATIONS

I nostri prodotti sono destinati all'industria petrolifera, chimica e petrolchimica, meccanica con applicazioni onshore, offshore e sottomarine. I prodotti speciali sono progettati dal nostro reparto ingegneria in collaborazione con i nostri clienti e testati nei nostri laboratori od in laboratori esterni riconosciuti. La nostra organizzazione è in grado di garantire la gestione di ogni tipo di progetto, dal primo take off al commissioning finale, in ogni paese del mondo per ogni tipo di prodotto e materiale e con supporto locale, sia commerciale che tecnico.

Our products are supplied to leading international offshore and onshore oil companies worldwide. The industries served by us include refining, oil and gas exploration, petrochemical, chemical, power generation and mechanical industries and applications are onshore, offshore and also subsea. Special products are engineered in our engineering department in collaboration with our clients taking into account their particular requirements and these products are then fully tested in our laboratory or in internationally recognised research laboratories. Our worldwide network of commercial offices are able to offer a complete range of piping components in all grades of material from initial take off to final commissioning, including full technical support where necessary to all of our customers.





GALPERTI FORGING ITALY



GALPERTI FORGING 2 ITALY



OFFICINE NICOLA GALPERTI S.P.A. & FIGLIO ITALY

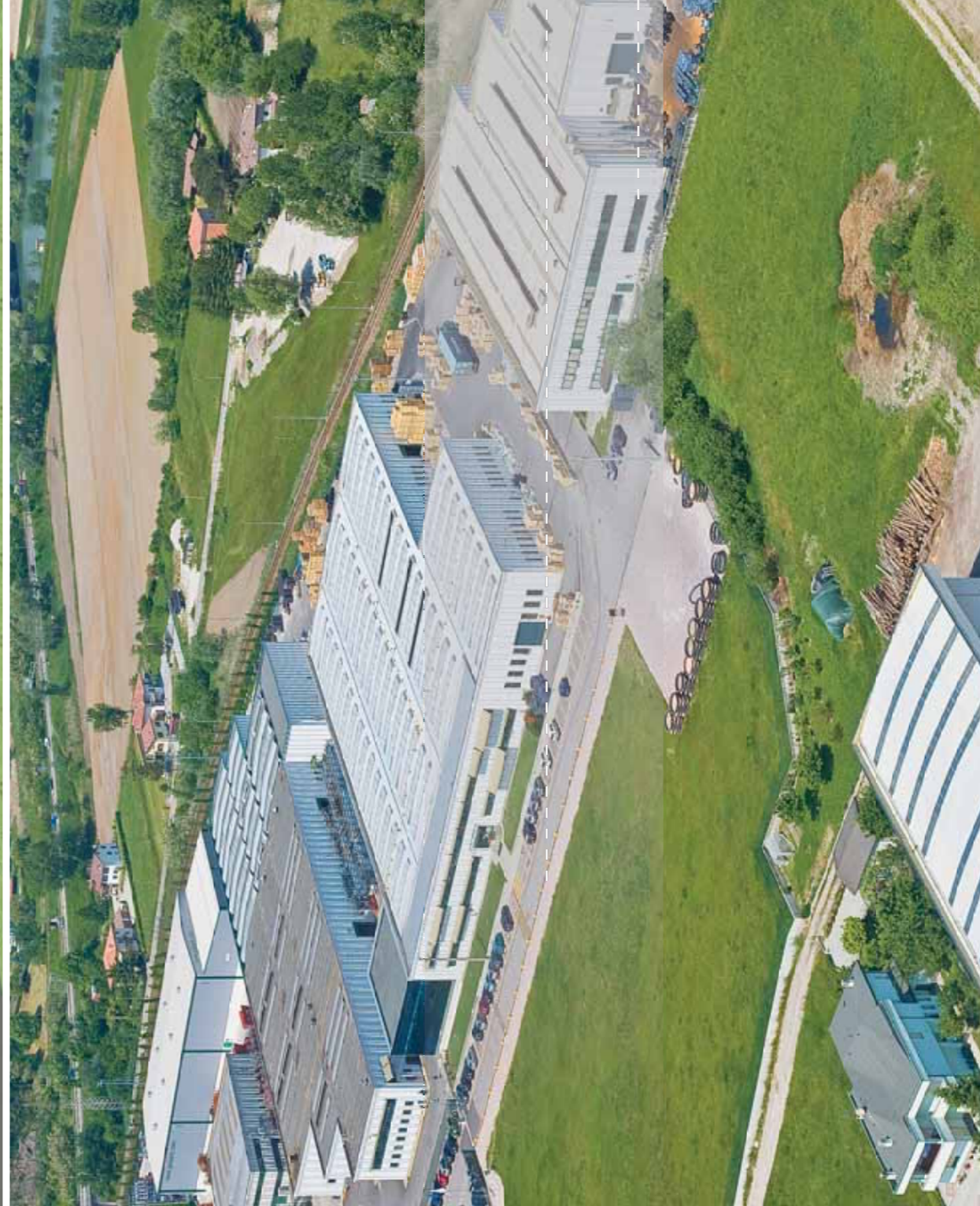

# OUR SIDE

GALPERTI ENGINEERING AND FLOW CONTROL S.R.L.





GALPERTI TECH S.R.L. ITALY



GALPERTI INC. - HOUSTON USA



# OUR SIDE

GALPERTI MIDDLE EAST U.A.E



# STOCK OF STEEL

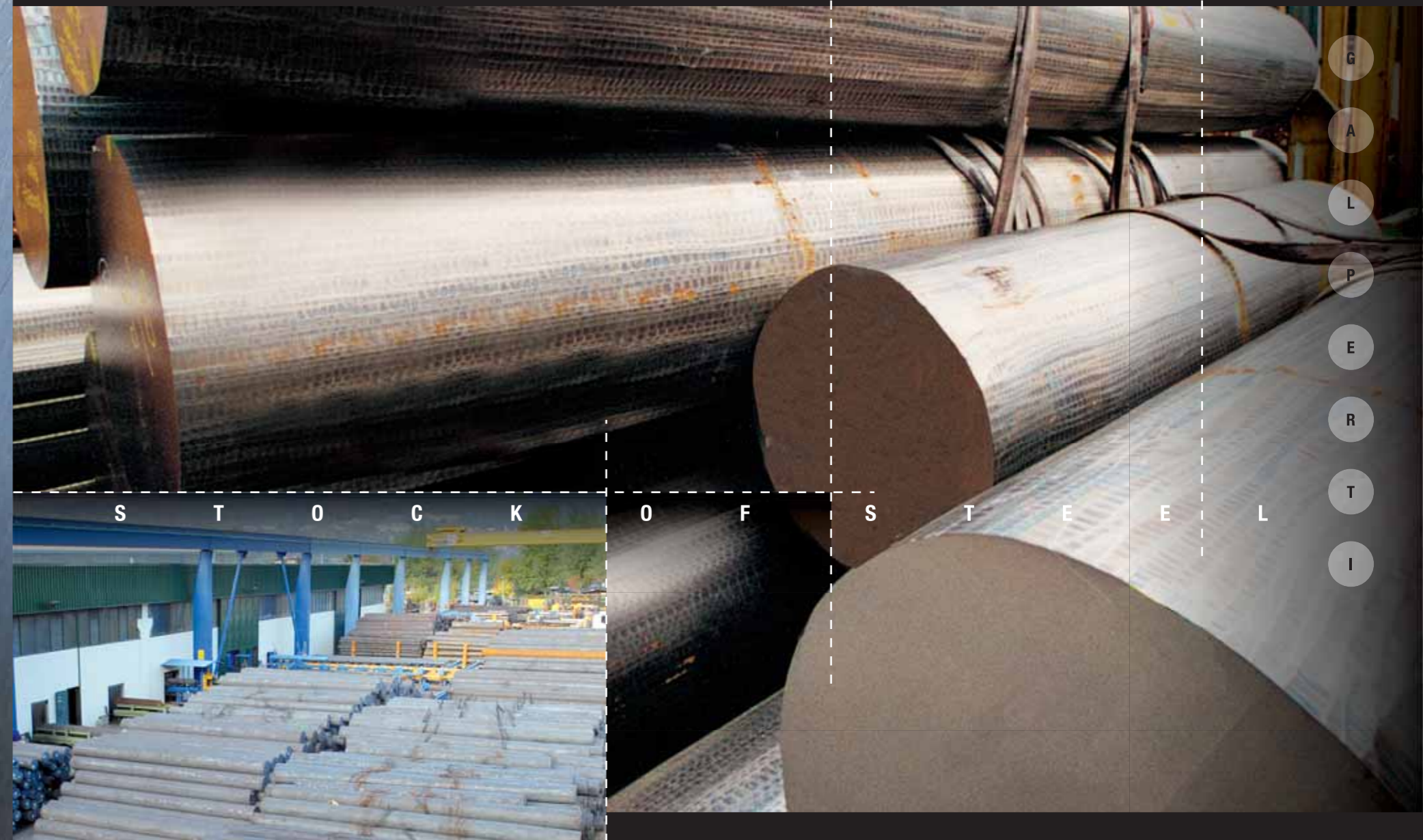

S T O C K   O F   S T E E L

G  
A  
L  
P  
E  
R  
T  
I

# CUTTING



C U T T I N G

- G
- A
- L
- P
- E
- R
- T
- I

# FORGING





F O R G I N G



FORGING  
12

**GALPERT**  
|||||



13  
FORGING



# HEAT TREATMENT







# MACHINING

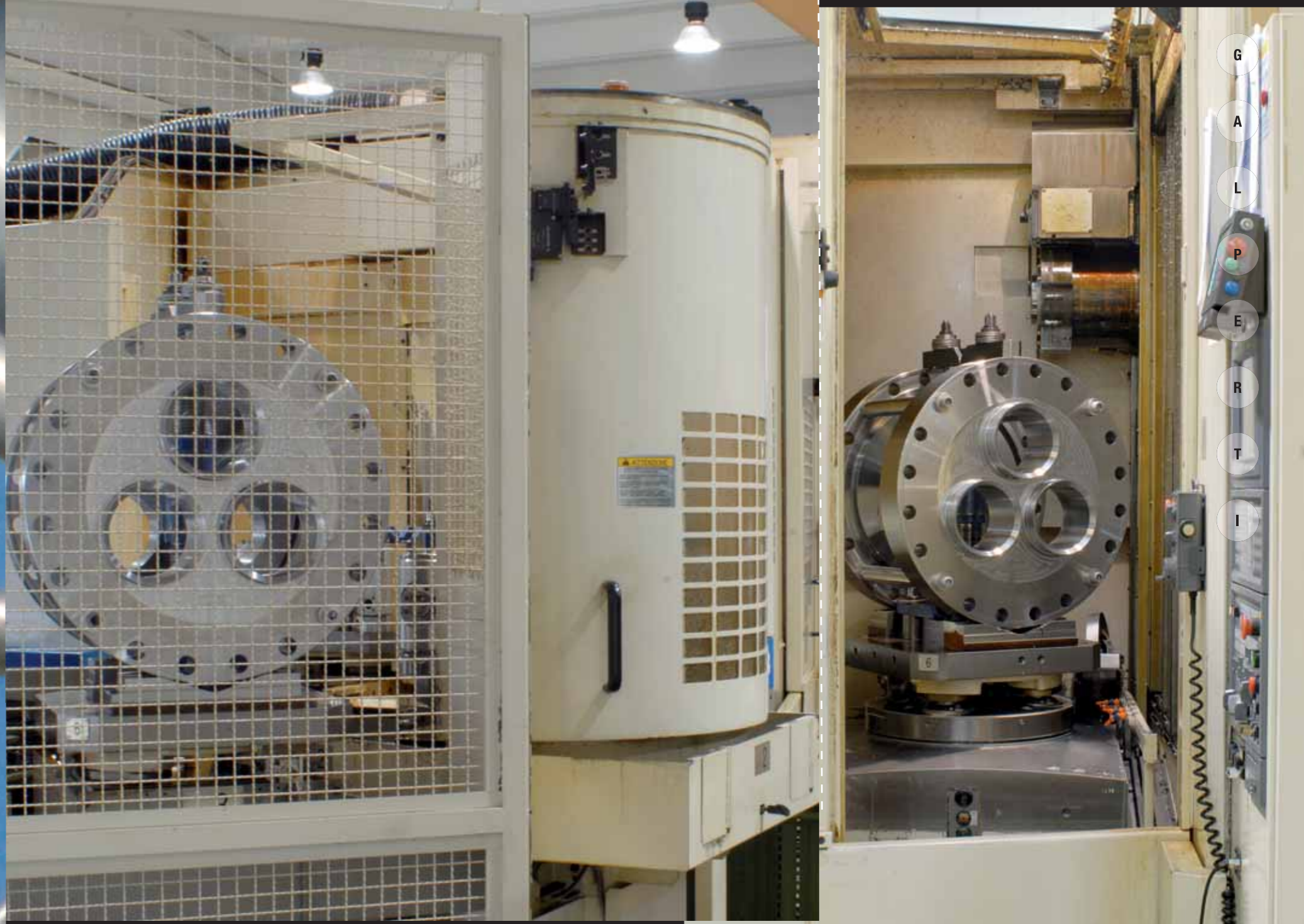
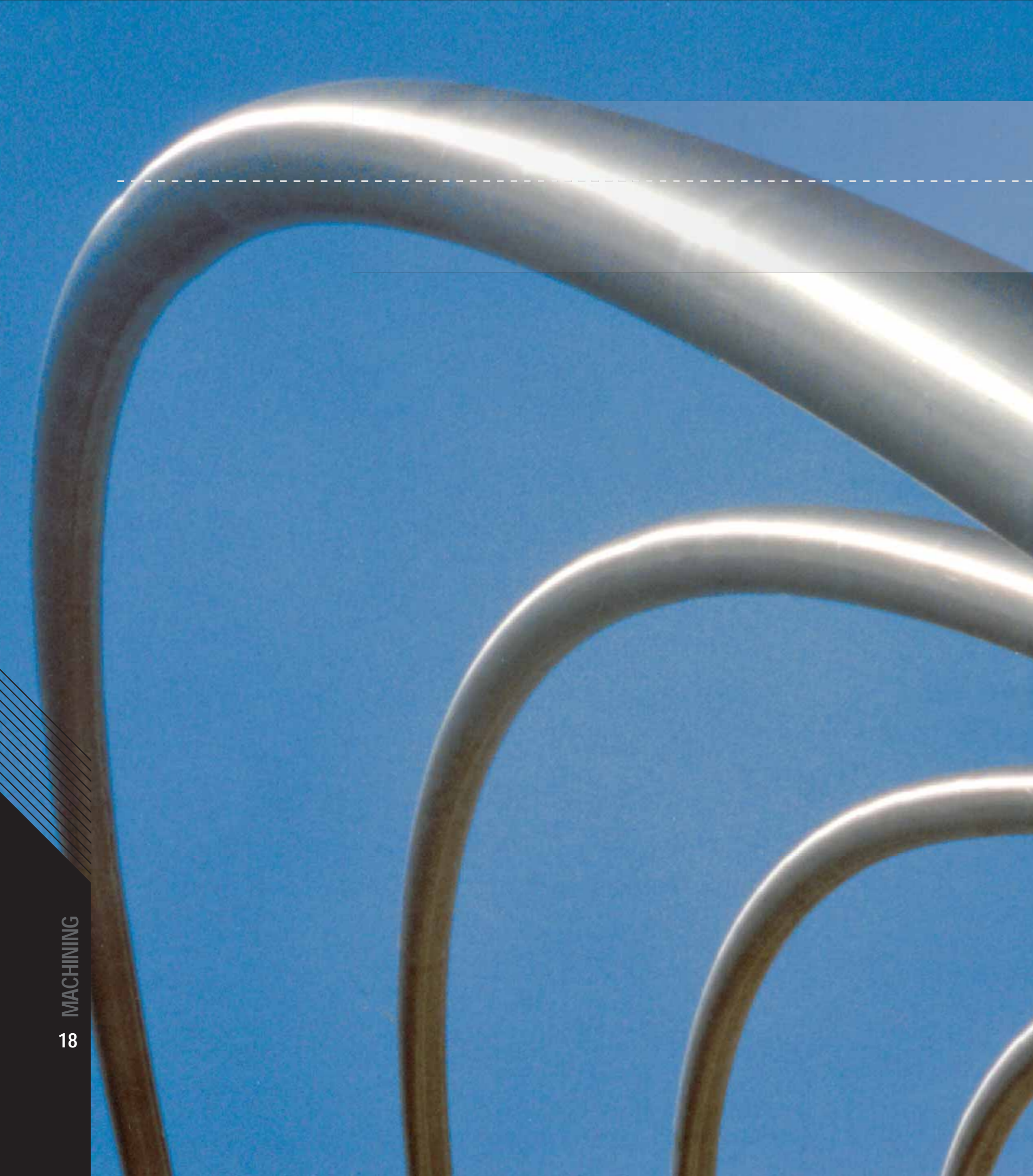



M A C H I N I N G



G  
A  
L  
P  
E  
R  
T  
I







G  
A  
L  
P  
E  
R  
T  
I

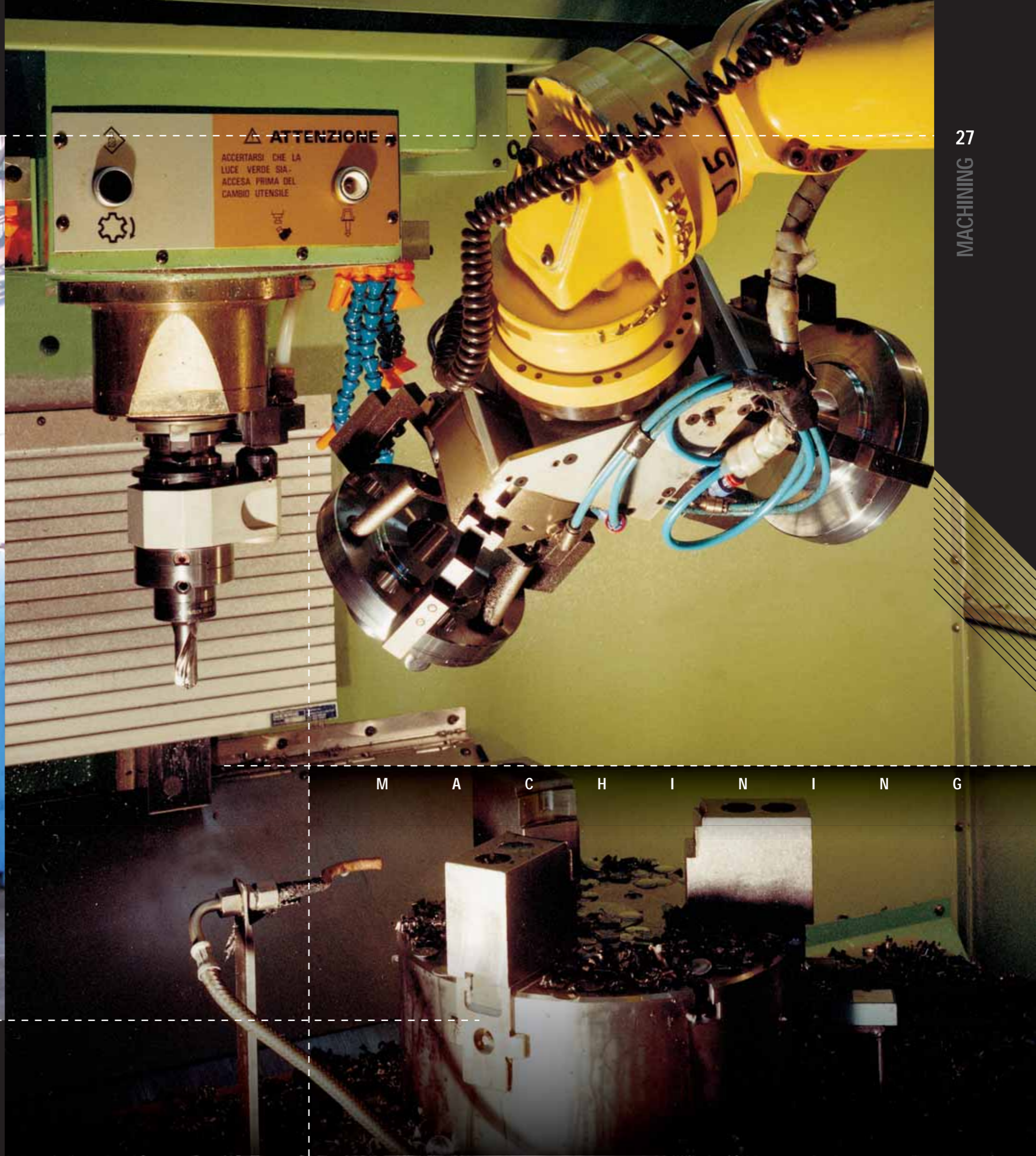

M A C H I N I N G



# WELDING

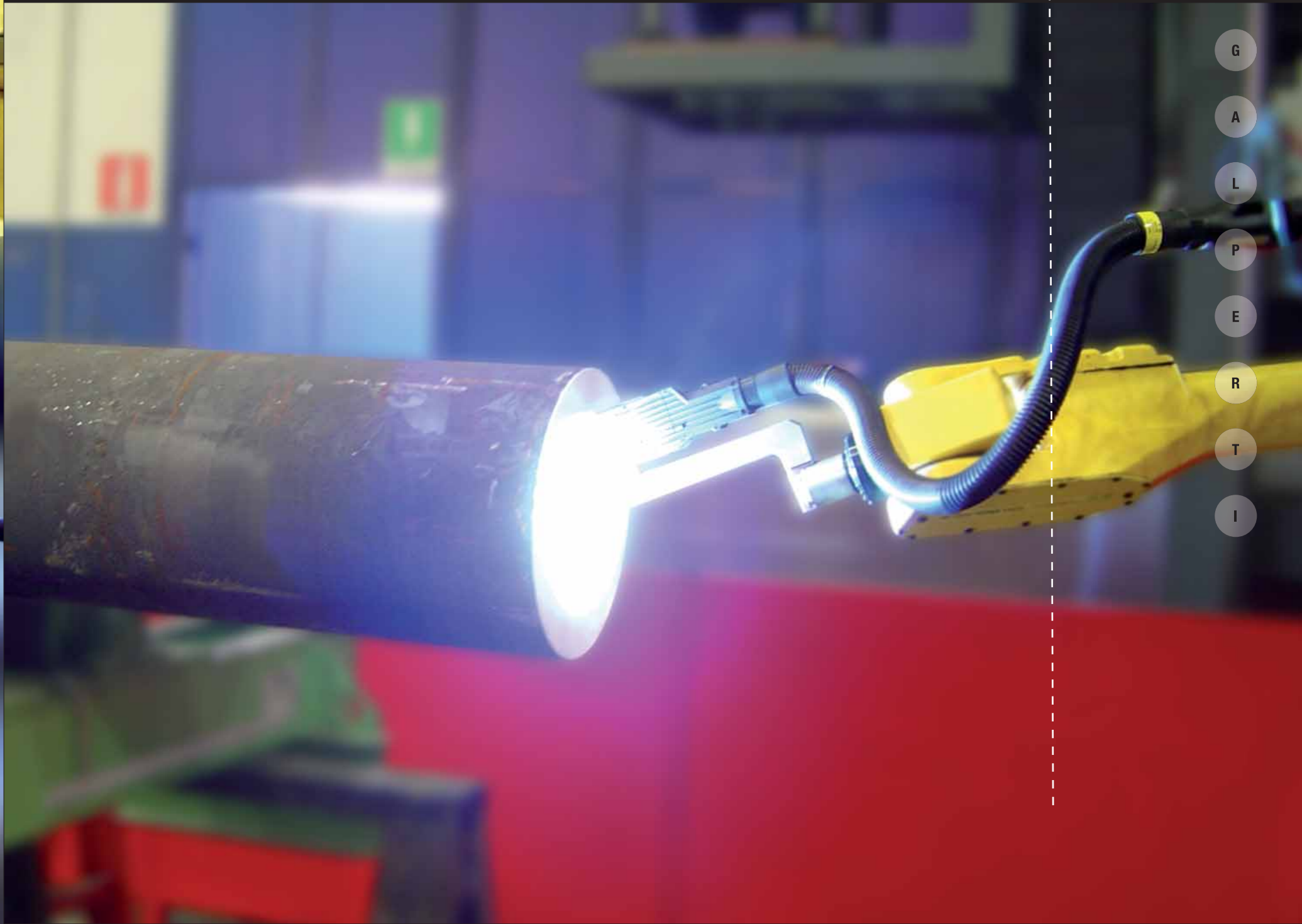

G  
A  
L  
P  
E  
R  
T  
I

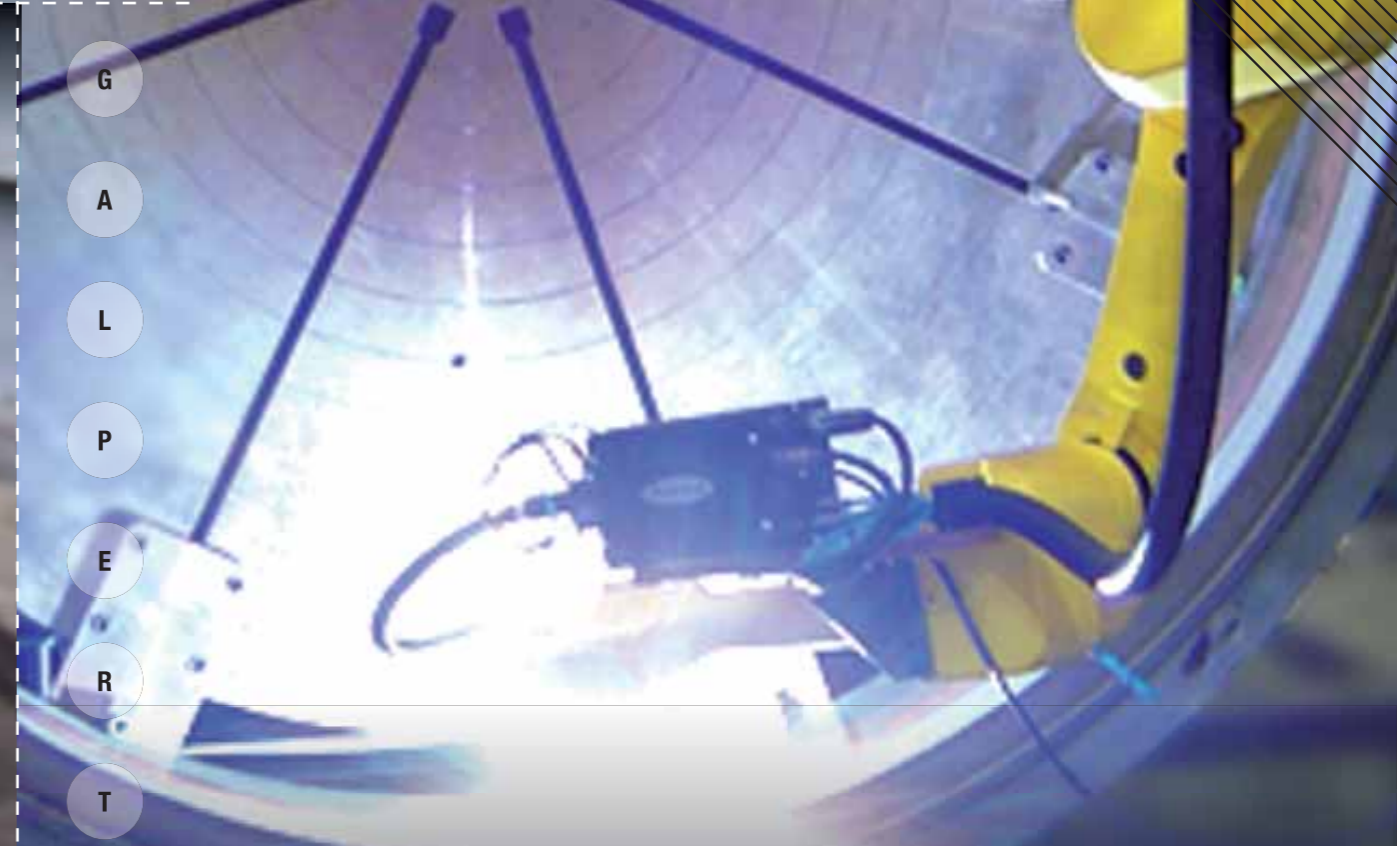
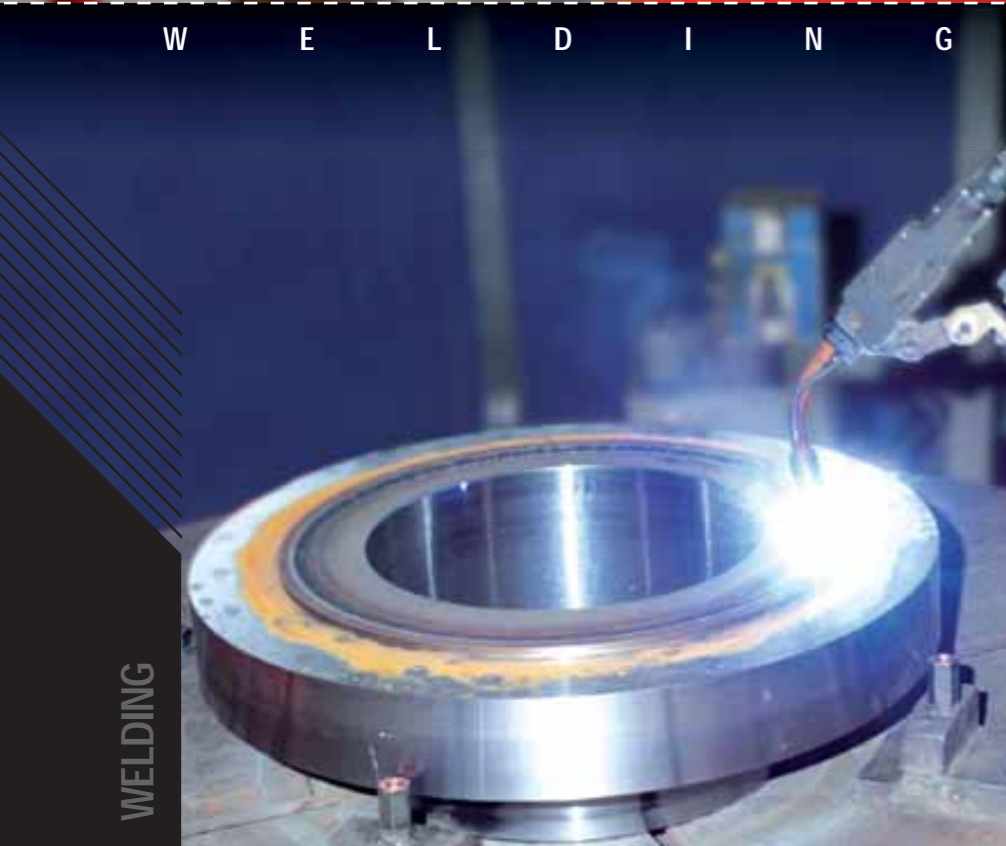
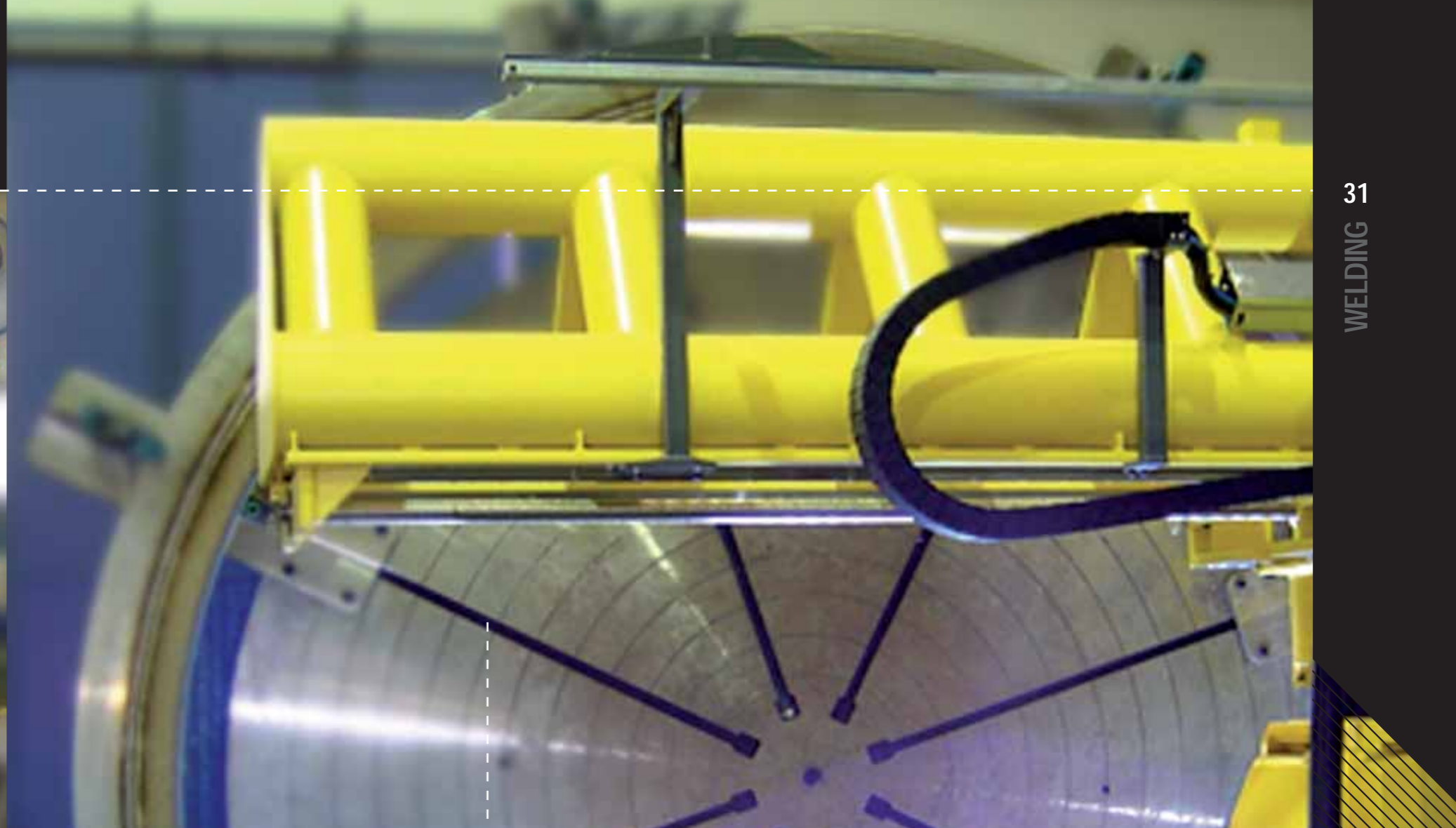

W E L D I N G

G  
A  
L  
P  
E  
R  
T  
I





# MARKING & COATING

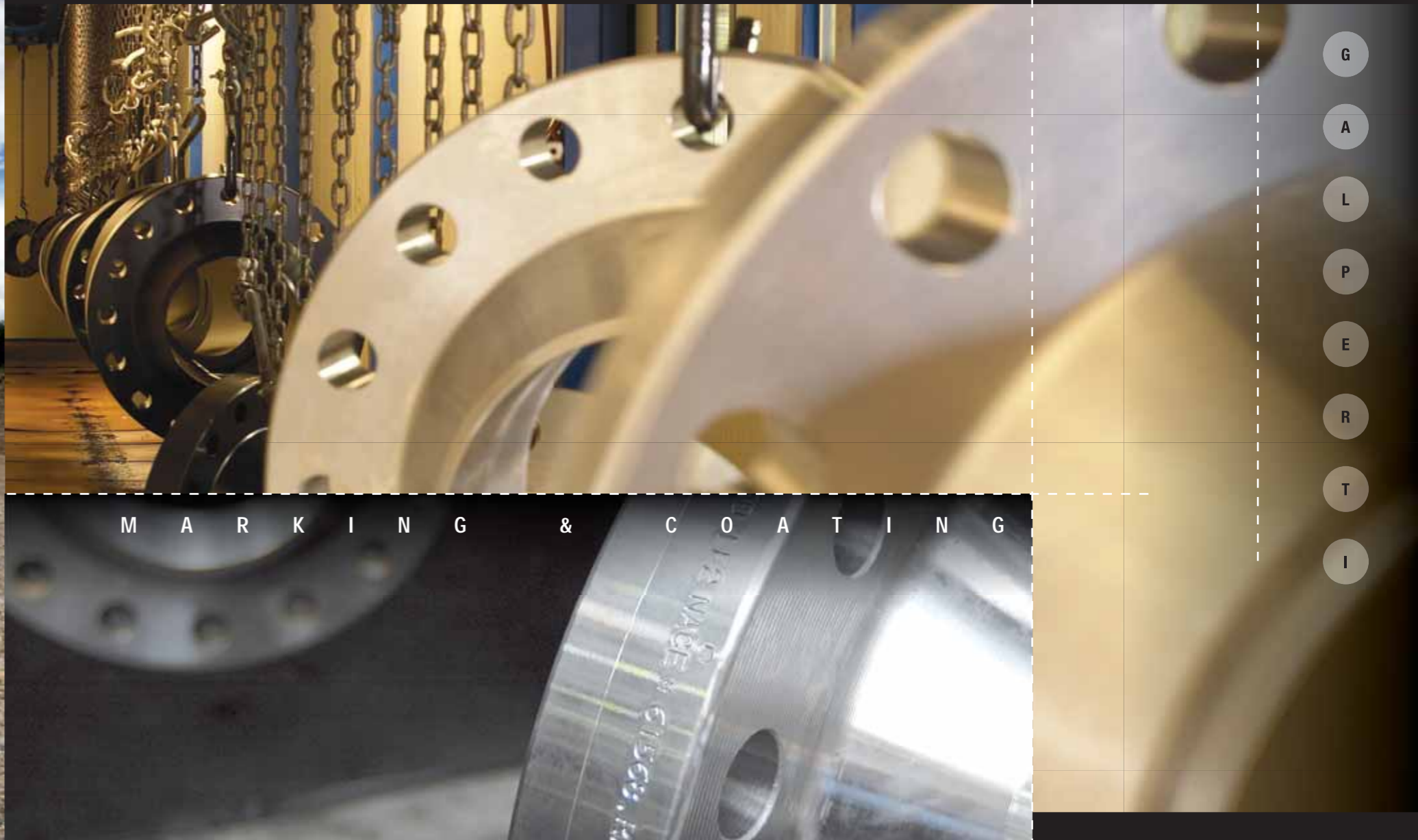

G  
A  
L  
P  
E  
R  
T  
I

M A R K I N G & C O A T I N G



# PACKING & SHIPMENT





P A C K I N G &



PACKING & SHIPMENT



S H I P M E N T

PACKING & SHIPMENT

# PRODUCTS



## FLANGES





# FLANGES

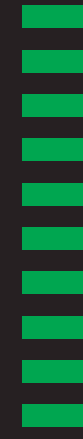



# G C C O M P A C T



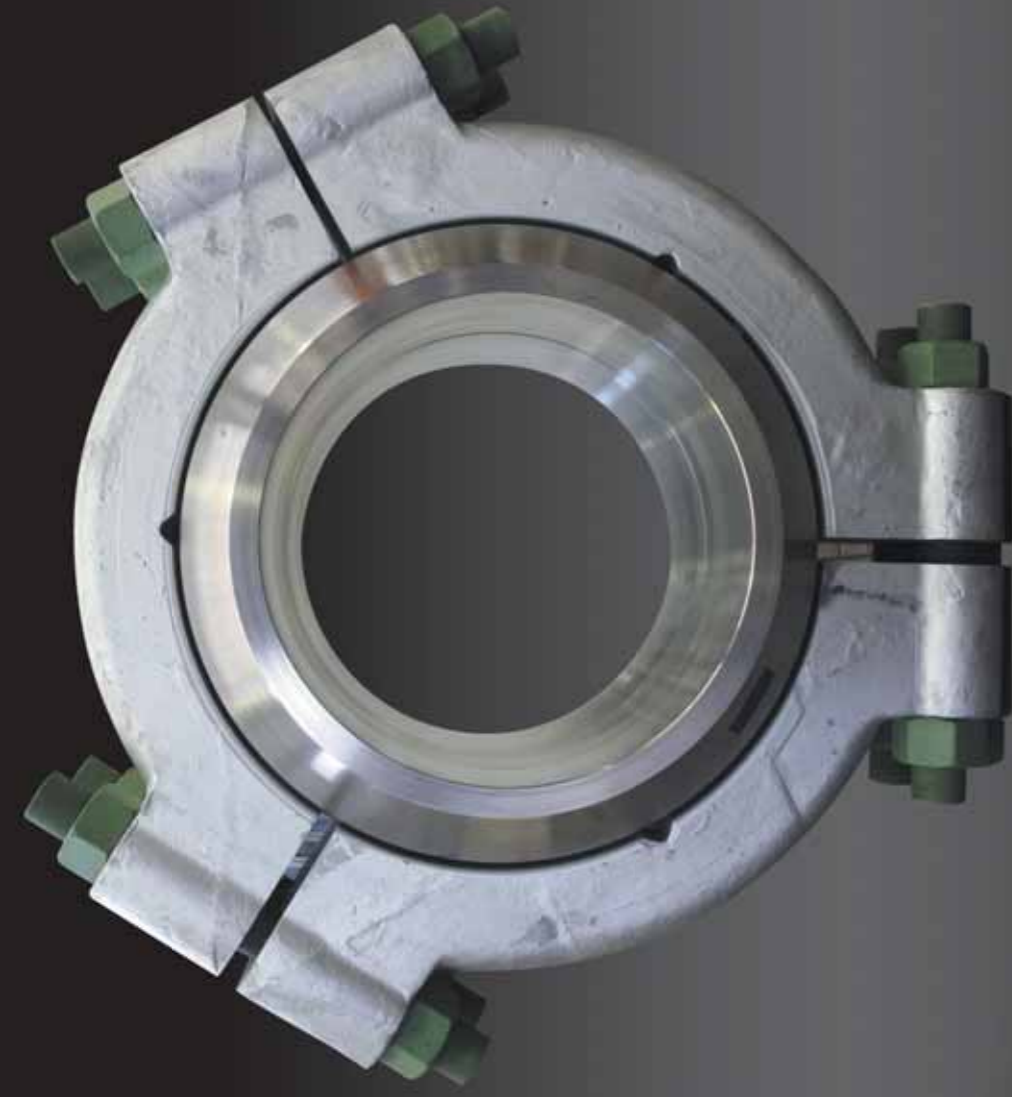

G - L O K



GALPERI

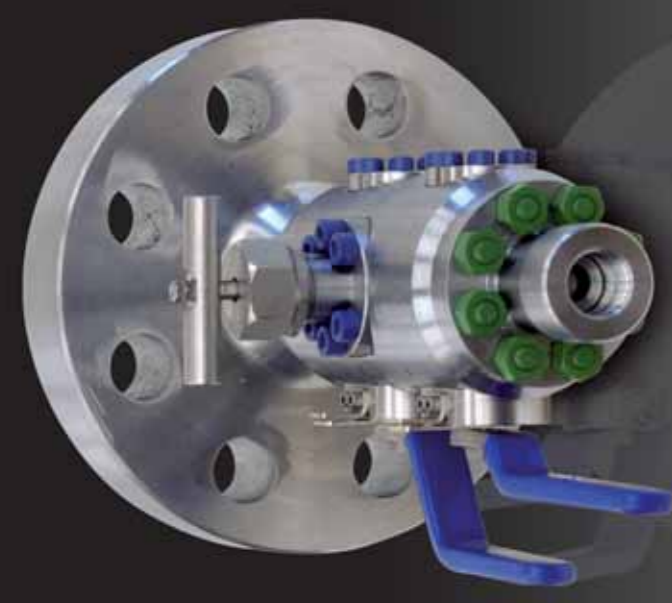

G - B L O K

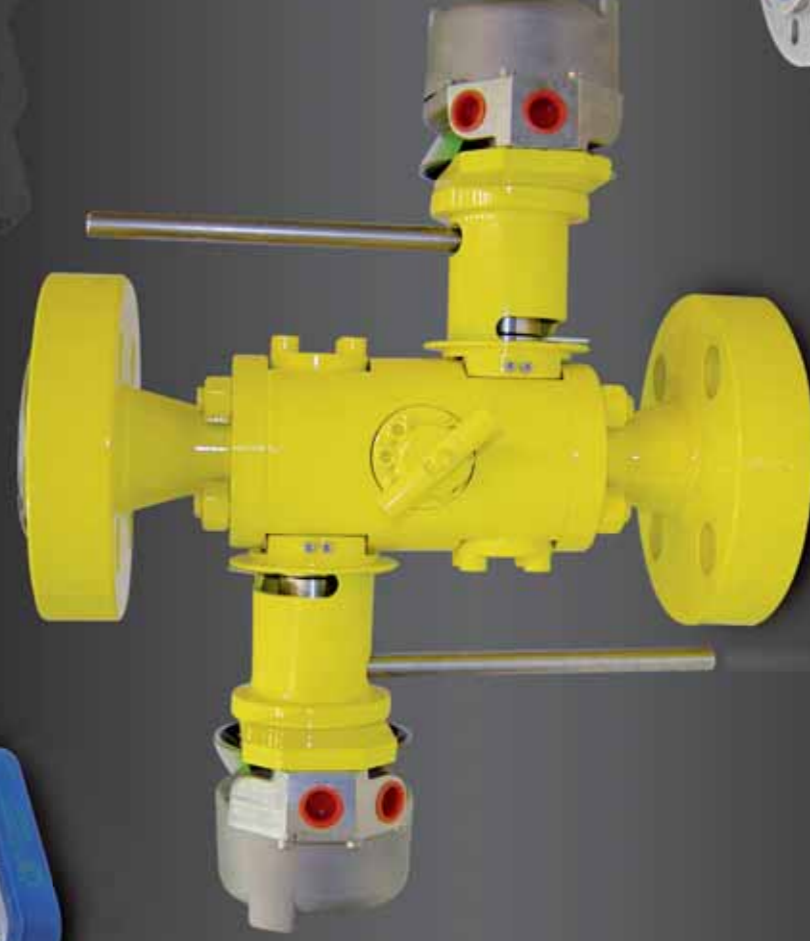





G - B L O K

GALPERI



SPECIALS



# FORGED PIPES



GALPERCI



T - L E T

G  
A  
L  
P  
E  
R  
T  
I



GALPERI



# GEARS & BEARINGS

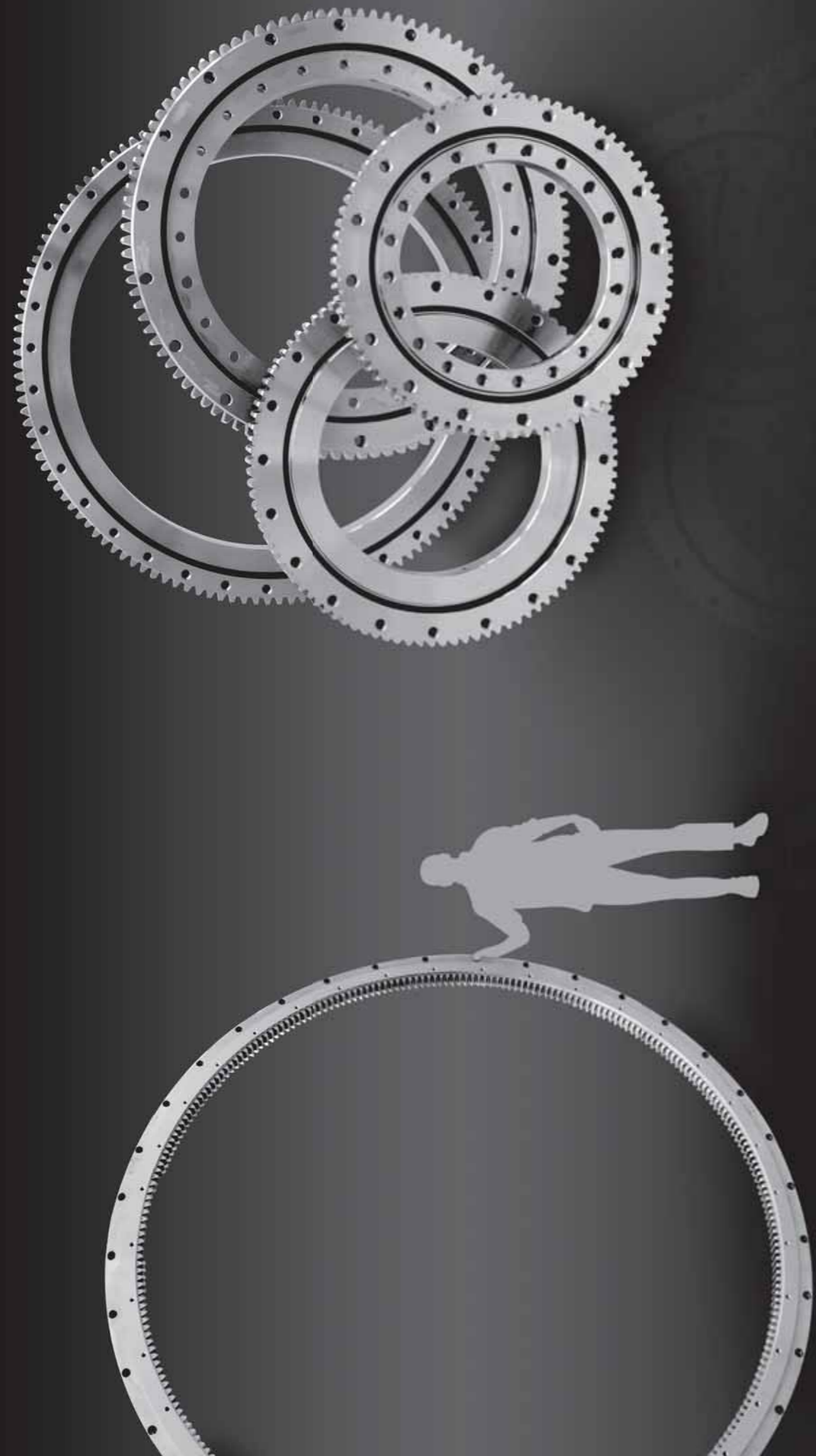

T E C H

G  
A  
L  
P  
E  
R  
T  
I



GALPERI

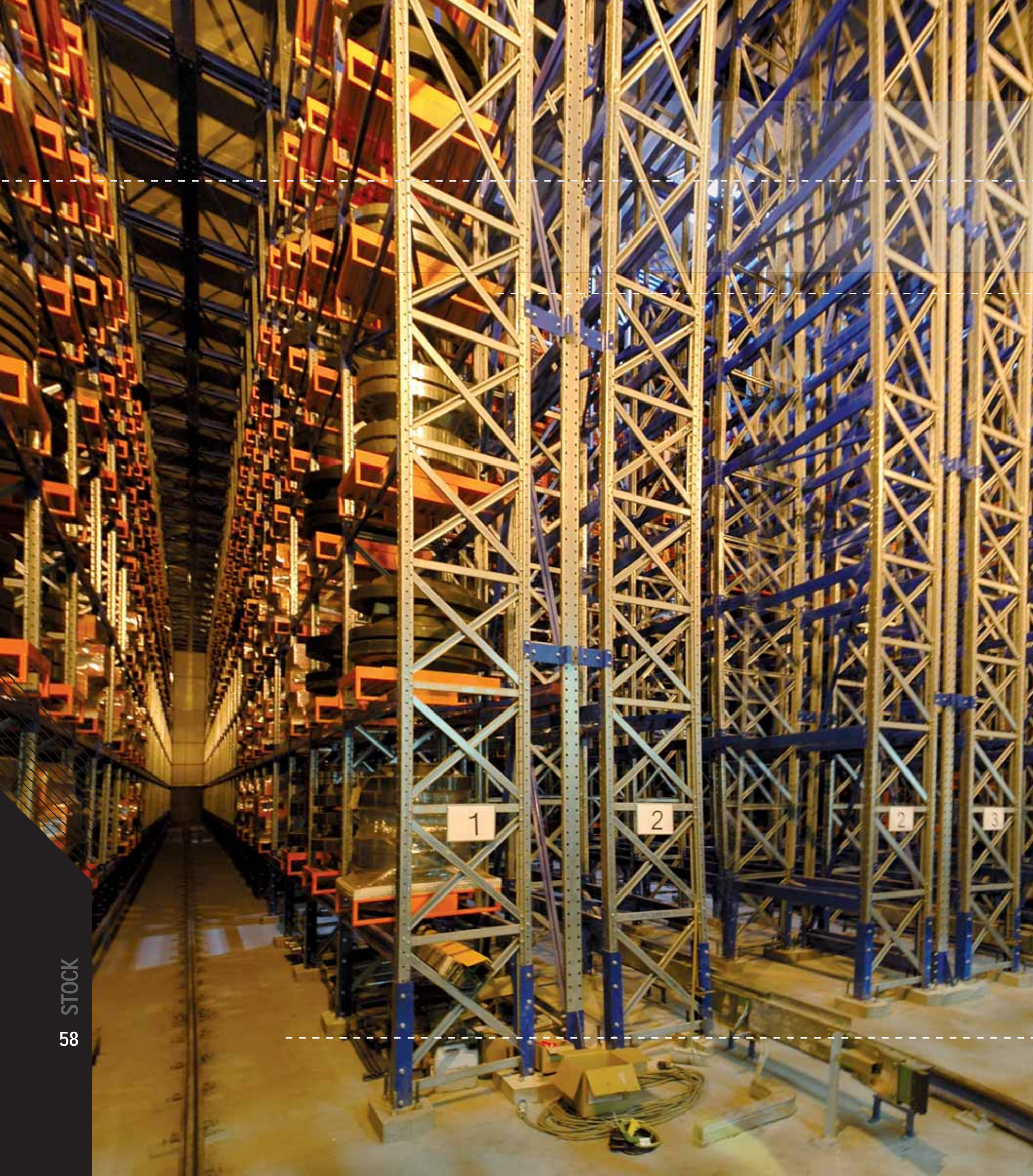

# STOCK





# ENGINEER-ING

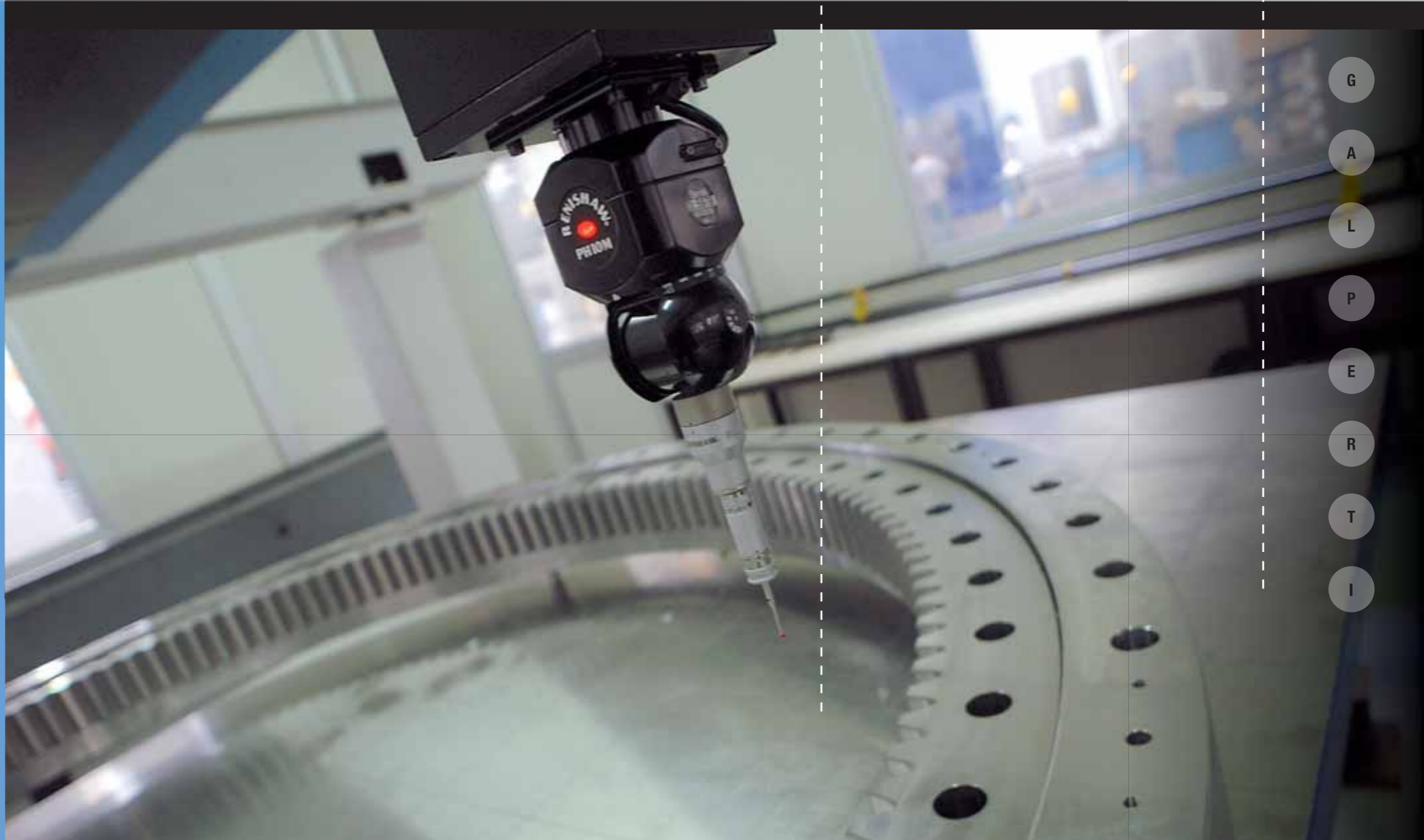

G  
A  
L  
P  
E  
R  
T  
I

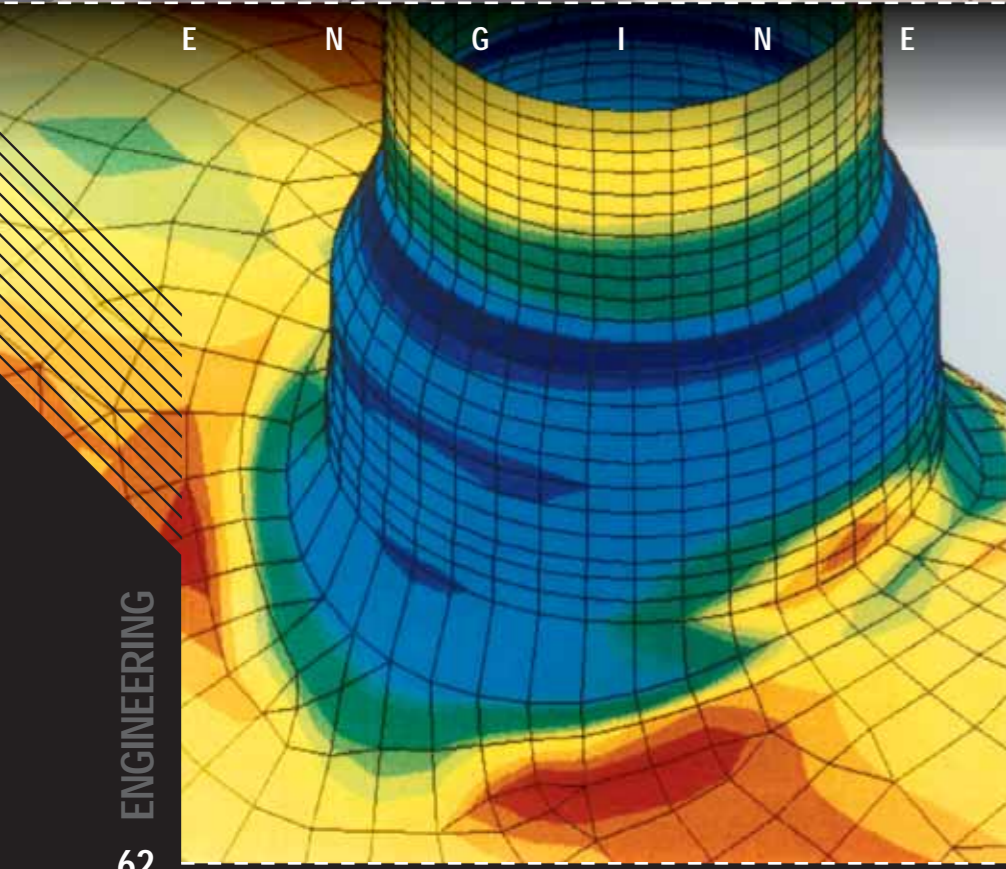



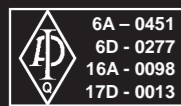
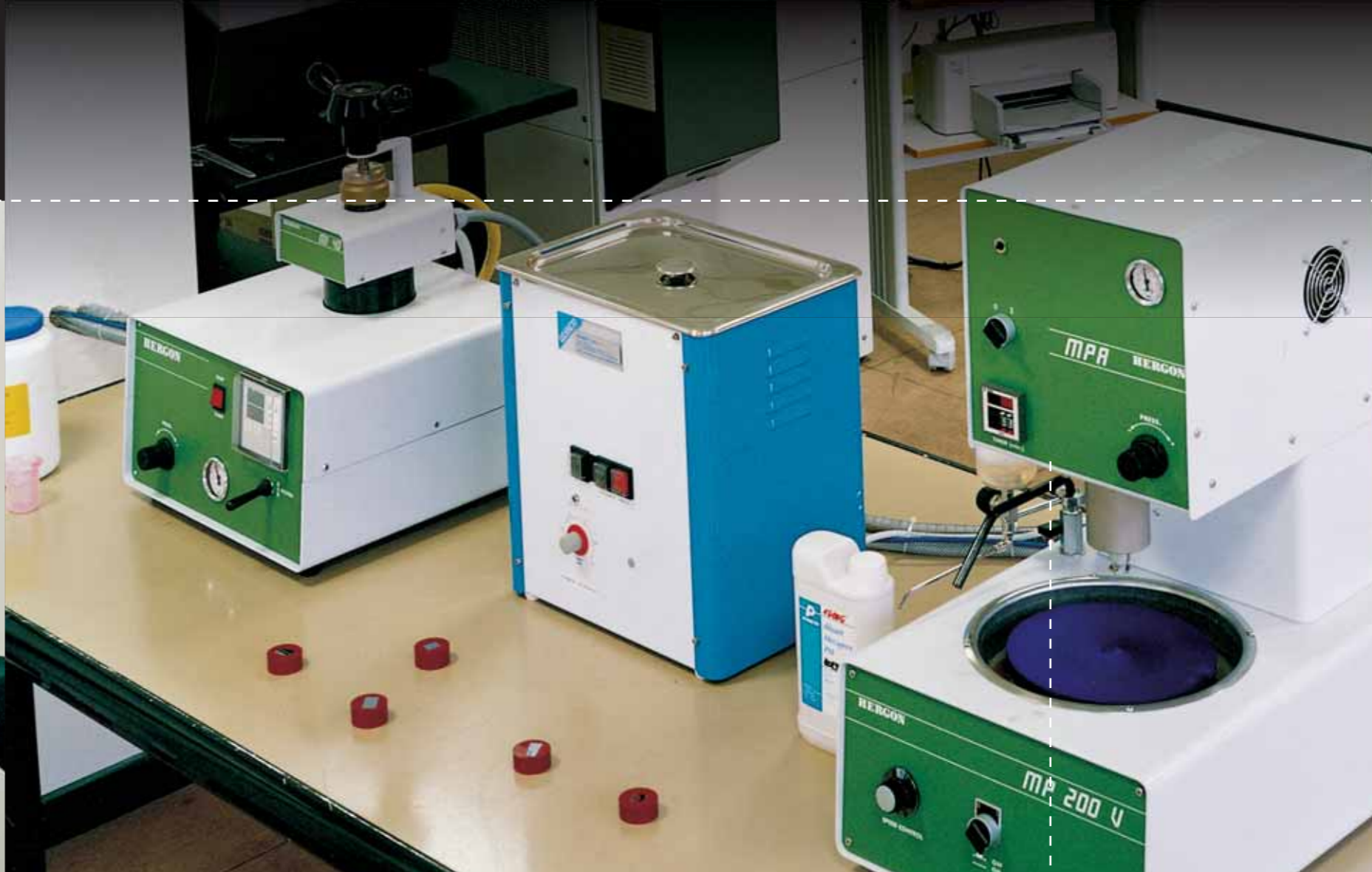

# WORLD WIDE

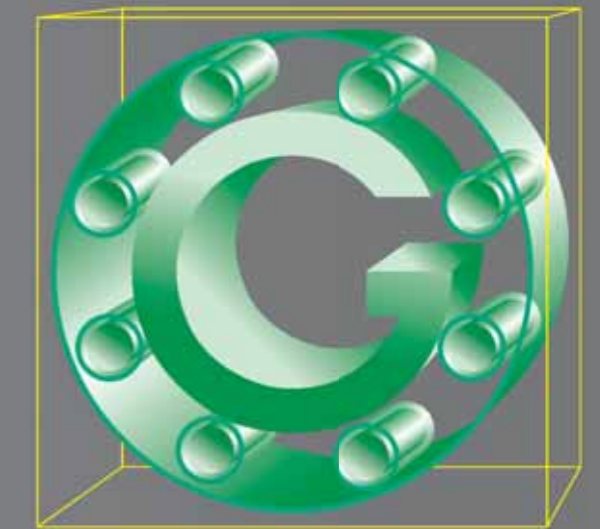

- |           |            |              |           |
|-----------|------------|--------------|-----------|
| CANADA    | NORWAY     | SPAIN        | KUWAIT    |
| U.S.A.    | DENMARK    | IRAN         | THAILAND  |
| VENEZUELA | GERMANY    | SAUDI ARABIA | MALAYSIA  |
| COLOMBIA  | NEDERLANDS | INDIA        | SINGAPORE |
| EQUADOR   | U.K.       | U.A.E.       | INDONESIA |
| BRASIL    | BELGIUM    | OMAN         | JAPAN     |
| ARGENTINA | FRANCE     | QATAR        | KOREA     |
| SWEDEN    | ITALY      | BAHRAIN      | AUSTRALIA |

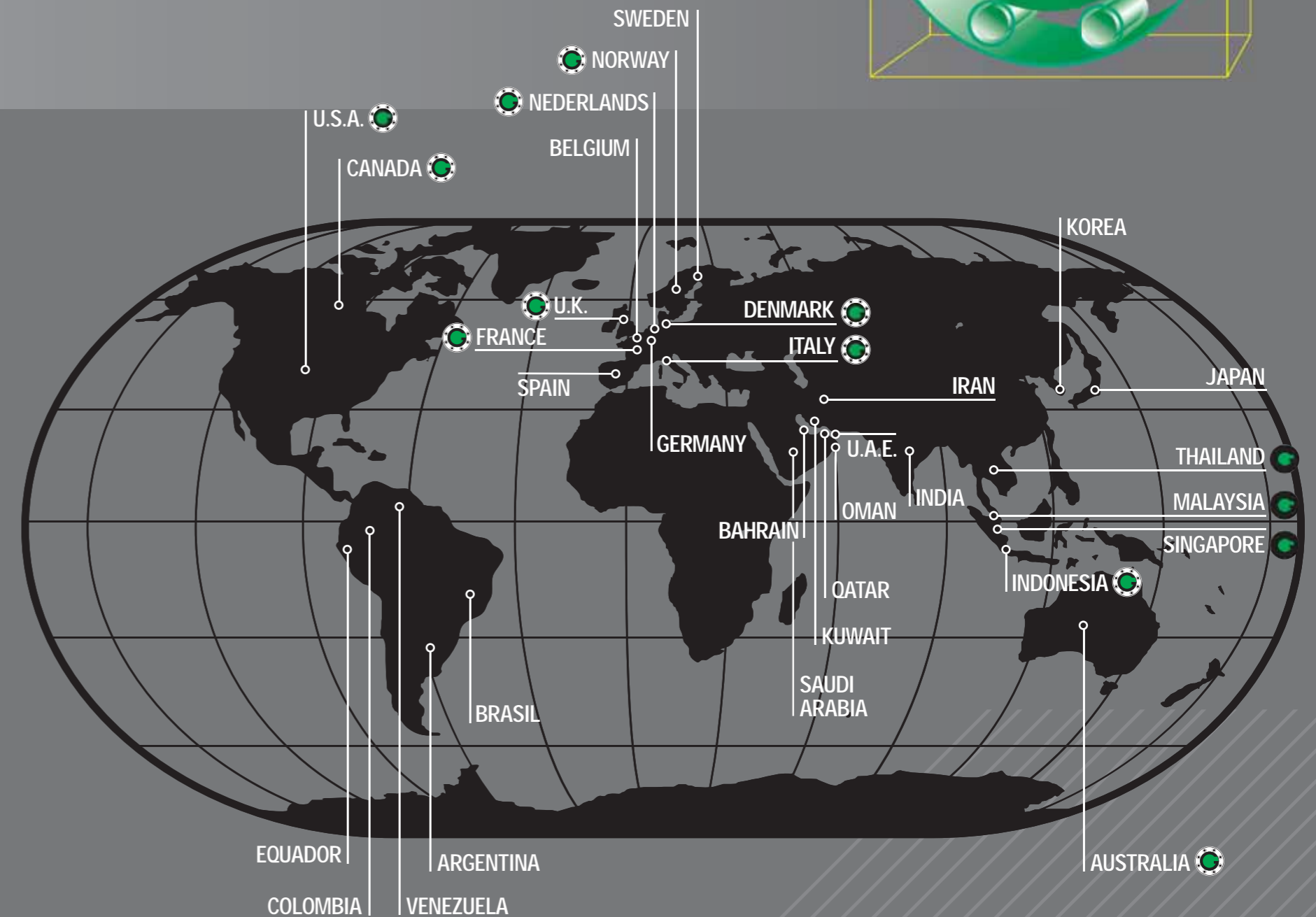

**GALPERCI**



# WORLD WIDE



■ **GALPERTI (HONG KONG) LTD**  
Beijing Representative Office  
Suite 709, Full Tower, No. 9 East 3rd - Ring Road  
Chaoyang District, Beijing, China 100020  
Tel. +8610-85911678, +8610-85911679  
Fax. +8610-85911677  
E-mail: michelle.zhao@galperti.com.cn

■ **S.F.F. SCANDINAVIAN FITTINGS  
AND FLANGES A/S NORWAY**  
Jakob Askelandsvei 5 - P.O. box 1175  
4391 Sandnes NORWAY  
Tel. +47 - 51639600  
Fax +47 - 51639601  
Web site: www.sff.no

■ **GALPERTI SOUTH EAST ASIA PTE LTD**  
No. 2 International Business Park,  
The Strategy #11-05, Singapore 609930  
Tel. +65-6267-8191 / 92  
Fax. +65-6267-8710  
E-mail: dontan@galperti.com.sg

■ **L.F.F. LONDON FITTINGS AND FLANGES LTD.**  
Christy Way - Southfields Industrial Park  
Basildon - Essex - SS15 6TE U.K.  
Tel. +44 - 1268 - 888500  
Fax +44 - 1268 - 888506  
Web site: www.lff.co.uk

■ **GALPERTI FRANCE SAS**  
Le Triangle 235 Rue Leon Foucault  
Parc de la Duranne  
13857 AIX EN PROVENCE  
CEDEX 3 - FRANCE  
Tel. +33-4-42594571  
Fax. +33-4-88714445  
E-mail: marc.justet@galpertifrance.eu

■ **P.F.F. EUROPE B.V.**  
Wielewaalweg 4 - 4791 PD Klundert  
The Netherlands  
Tel. +31 (0) 168 387 410  
Fax. +31 (0) 168 387420  
Web site: www.PFF.nl

**GALPERTI**



