

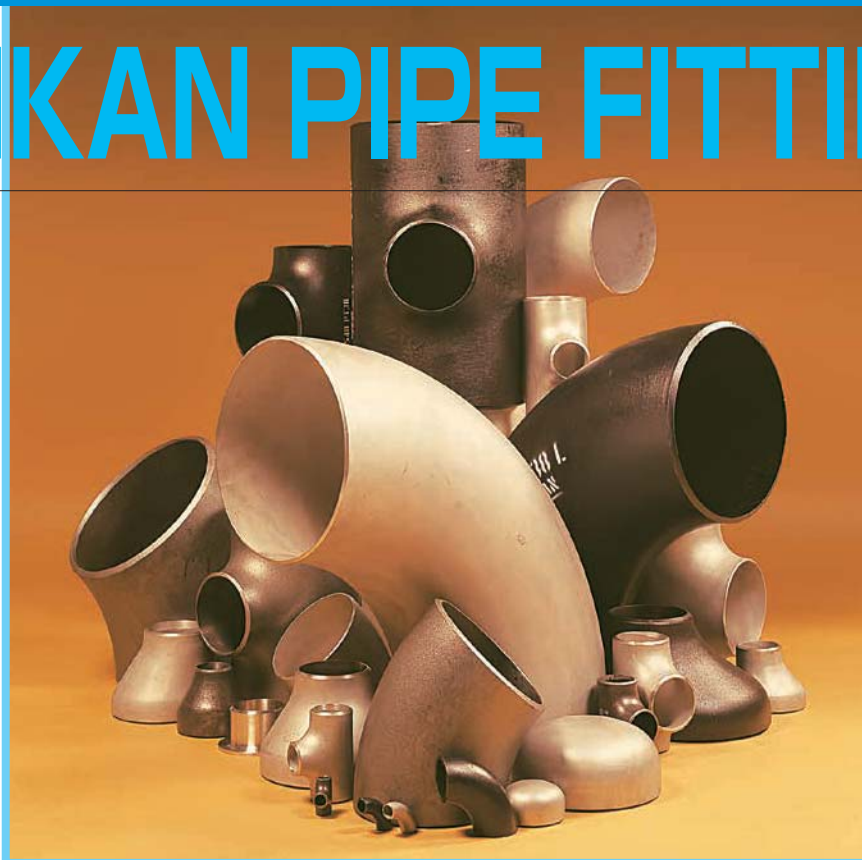

BENKAN PIPE FITTINGS



CONTENTS

<i>BENKAN</i> Butt-Welding Fittings.....	1
Inspection Procedure.....	3
Wall Thickness Schedules.....	5
Butt-Welding Fittings Weight and Volume	9
Long and Short Radius Elbows	11
Straight and Reducing Tees.....	13
Concentric and Eccentric Reducers.....	16
Caps	17
Stainless Steel Lap Joint Stub Ends	18
Material Specification for Butt-Welding Fittings	19

***BENKAN* Butt-Welding Fittings**

Wrought Steel Butt-Welding Fittings

(Carbon and Alloy Steel)



45° Elbow (Long)



Cap



90° Elbow (Long)



180° Elbow (Long)



T (Straight)



Reducer (Concentric)

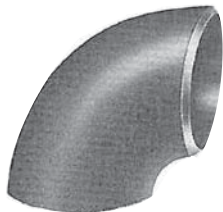

90° Elbow (Short)



180° Elbow (Short)



T (Reducing)



Reducer (Eccentric)

Large Diameter Wrought Steel Butt-Welding Fittings (Carbon, Alloy and Stainless Steel)



45° Elbow (Long)



90° Elbow (Long)

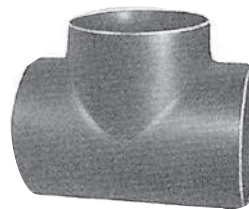

T (Straight)



Reducer (Concentric)



Cap



90° Elbow (Short)

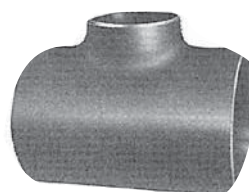

T (Reducing)



Reducer (Eccentric)

Stainless Steel Butt-Welding Fittings



90° Elbow (Long)



T (Straight)

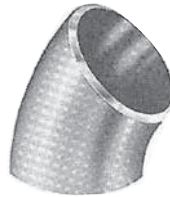

45° Elbow (Long)



Cap



90° Elbow (Short)



T (Reducing)



Reducer (Concentric)



Lap Joint Stub End



Reducer (Eccentric)

Material Items	Carbon and Alloy Steel	Stainless Steel
	Coating	Rust-resistant paint (black)
Making	Die stamping	Electrolysis etching

Inspection Procedures

BENKAN butt-welding fittings are subjected to strict in-process inspection at each stage of the production process - from starting materials handling to finished product shipping. They are visually examined for conformity to company specifications and tested under the applicable ASTM, ASME, MSS and JIS codes and standards. They are also tested to make sure they conform to their intended use. Upon request, we call in officially certified test agents to witness the inspection procedures. **BENKAN** butt-welding fittings are manufactured in conformity with the following standards.

APPLICABLE STANDARDS

ASTM A234	Piping Fittings of Wrought Carbon Steel and Alloy Steel for Moderate and High Temperatures Service
ASTM A403	Wrought Austenitic Stainless Steel Piping Fittings
ASTM A420	Piping Fittings of Wrought Carbon Steel and Alloy Steel for Low-Temperature Service
ASME B16.9	Factory-Made Wrought Steel Butt-Welding Fittings
MSS SP-43	Wrought Stainless Steel Butt-Welding Fittings
MSS SP-75	High Test Wrought Butt Welding Fittings
JIS B2309	Butt-Welding Pipe Fittings for Light Gauge Stainless Steel Tubes for Ordinary Use
JIS B2311	Steel Butt-Welding Pipe Fittings for Ordinary Use
JIS B2312	Steel Butt-Welding Pipe Fittings
JIS B2313	Steel Plate Butt-Welding Pipe Fittings
JIS B2316	Steel Socket-Welding Pipe Fittings
JIS B2321	Aluminum and Aluminum Alloy Butt-Welding Pipe Fittings

STARTING MATERIAL RECEIVING INSPECTION

BENKAN butt-welding fittings are made of materials which meet ASTM and intracompany specifications.

Starting material inspection is carried out as follows:

1) Dimensional Inspection

Dimensions are inspected at each end of the purchased material.

2) Visual Inspection

Inspection is performed according to **BENKAN**'s "acceptable surface condition" standard.

3) Collating

Judgement is made as to whether it is worthy of the inspection by computerised collating the described items with the materials certificates.

The following other inspections are performed if necessary.

- Ultrasonic Examination
- Magnetic Particle Examination
- Radiographic Examination
- Liquid Penetrant Examination
- Ultrasonic Thickness Inspection
- Mechanical Test
- Others

IN-PROCESS INSPECTION

BENKAN butt-welding fittings are manufactured with carefully selected materials of the finest metallurgical quality on well-controlled jigs, tools or molds based on **BENKAN**'s various working standards. Meeting quality specifications is a key feature of **BENKAN** butt-welding fittings.

The following are the major in-process inspection items.

- Visual Inspection
- Dimensional Inspection
- Shape Inspection
- Hardness Test
- Temperature Check
- Processing Conditions Check
- Material Identification (by marking)
- Others

FINAL INSPECTION

The final inspection of **BENKAN** butt-welding fittings is performed as follows:

1) Standard Product Inspection

Applicable for **BENKAN** butt-welding fittings produced under ASME B16.9 and other specifications.

VISUAL INSPECTION

BENKAN butt-welding fittings are visually inspected to confirm that both internal and external surfaces are smooth and without harmful defects. **BENKAN**'s "acceptable surface condition" standard is used as the standard for visual tests.

DIMENSIONAL INSPECTION

BENKAN butt-welding fittings are inspected for conformity with ASME or MSS dimensional tolerances (see table on page 24-27).

2) Special Product Inspection

Applicable for every products manufactured to meet specifications requested by customers.

VISUAL INSPECTION

BENKAN butt-welding fittings are visually inspected. Criteria are based on those of the standard product. Special specifications are determined by agreement between the customer and BENKAN.

DIMENSIONAL INSPECTION

The inspection is usually based on specifications stipulated by the customer.

SPECIAL INSPECTION

In the case of "special requirements" specified by the customer, nondestructive examinations and mechanical tests are performed.

3) Inspection Certificates

BENKAN certificates are issued in the following form unless otherwise requested by the customer.

INSPECTION BY VARIOUS AUTHORITIES

1) Inspection by a Bureau of Shipping

Products subject to this inspection are made from starting materials stipulated by the regulations of the bureau. The starting materials and products are inspected for appearance, dimensions, and conformity to designated specifications. The Bureau of Shipping witnesses and certifies inspection, and certificates from them are forwarded to the customer. **BENKAN** butt-welding fittings are inspected by the following Bureaus of Shipping:

- ABS (ABS PACIFIC DIVISION)
- B.V (Bureau Veritas)
- LRS (Lloyd's Register ASIA)
- NK (Nippon Kaiji Kyokai)
- DNV (Det Norske Veritas)

2) Inspection by Other Organizations

- JIC (Japan Inspection Co.,Ltd.)
- SGS (SGS FAR EAST LTD.)
- MOODY INTERNATIONAL LTD.

Purchaser : 需要家名		SAMPLE		INSPECTION CERTIFICATE 検査証明書	
		BENKAN BENKAN KIKOH Corporation 株式会社ベンカン機工			
		KIRYU FACTORY 製作工場		Date :日付	
BENKAN No. ベンカン番号		Order No. 注文番号		Certificate No. 証明書番号	
		5-1 ROKUSENGOKU-CHO OTA CITY 群馬県太田市六丁右町5-1		M D Y 月 日 年	
		GUNMA PREF. JAPAN		TEL. 027737-4112	
Job No. 工 事 番 号		Specification for Material 材 料 規 格		Specification for Inspection 検 査 規 格	
MFG No (Heat Identification No.) 製 造 番 号		Product & Size 品 名 及 び 寸 法		Quantity 数 量	
Material Heat No. 製 鋼 番 号					
		Chemical Composition 化 学 成 分 %		Tension Test 引張試験	
Specification		C Si Mn P S		Y S T S E	
規定値		100 100 100 1000 1000		N/mm ² %	
Min. 最小					
Max. 最大					
<p>We hereby certify that the product described herein has been manufactured in accordance with the specifications concerned and also with the purchaser's requirements and that the test results shown herein are correct. 上記注文及び引張試験の規格と引張試験に従って製造され、その要求事項を満足していることを証明します。 *1: The symbol "T" after wall thickness means mm as unit. 厚さの数値の後に示す "T" はmm単位を意味します。 *2: YS=Yield strength 降伏力 YP=Yield point 降伏点 TS=Tensile strength 引張り強さ El=Elongation 伸び</p>					
				Manager of Quality Assurance Section 品質保証課長	

Wall Thickness Schedules (ASME)

Nominal Pipe Size		Outside Diameter	Nominal Wall Thickness							
A	B		Sch5S	Sch10S	Sch40S	Sch80S	Sch5	Sch10	Sch20	Sch30
8	1/4	13.7	—	1.65	2.2	3.0	—	1.65	—	1.9
10	3/8	17.1	—	1.65	2.3	3.2	—	1.65	—	1.9
15	1/2	21.3	1.65	2.1	2.8	3.7	1.65	2.1	—	2.4
20	3/4	26.7	1.65	2.1	2.9	3.9	1.65	2.1	—	2.4
25	1	33.4	1.65	2.8	3.4	4.5	1.65	2.8	—	2.9
32	1-1/4	42.2	1.65	2.8	3.6	4.9	1.65	2.8	—	3.0
40	1-1/2	48.3	1.65	2.8	3.7	5.1	1.65	2.8	—	3.2
50	2	60.3	1.65	2.8	3.9	5.5	1.65	2.8	—	3.2
65	2-1/2	73.0	2.1	3.0	5.2	7.0	2.1	3.0	—	4.8
80	3	88.9	2.1	3.0	5.5	7.6	2.1	3.0	—	4.8
90	3-1/2	101.6	2.1	3.0	5.7	8.1	2.1	3.0	—	4.8
100	4	114.3	2.1	3.0	6.0	8.6	2.1	3.0	—	4.8
125	5	141.3	2.8	3.4	6.6	9.5	2.8	3.4	—	—
150	6	168.3	2.8	3.4	7.1	11.0	2.8	3.4	—	—
200	8	219.1	2.8	3.8	8.2	12.7	2.8	3.8	6.4	7.0
250	10	273.0	3.4	4.2	9.3	12.7	3.4	4.2	6.4	7.8
300	12	323.8	4.0	4.6	9.5	12.7	4.0	4.6	6.4	8.4
350	14	355.6	4.0	4.8	9.5	12.7	4.0	6.4	7.9	9.5
400	16	406.4	4.2	4.8	9.5	12.7	4.2	6.4	7.9	9.5
450	18	457.2	4.2	4.8	9.5	12.7	4.2	6.4	7.9	11.1
500	20	508.0	4.8	5.5	9.5	12.7	4.8	6.4	9.5	12.7
550	22	558.8	4.8	5.5	—	—	4.8	6.4	9.5	12.7
600	24	609.6	5.5	6.4	9.5	12.7	5.5	6.4	9.5	14.3
650	26	660.4	—	—	—	—	—	7.9	12.7	—
700	28	711.2	—	—	—	—	—	7.9	12.7	15.9
750	30	762.0	6.4	7.9	—	—	6.4	7.9	12.7	15.9
800	32	812.8	—	—	—	—	—	7.9	12.7	15.9
850	34	863.6	—	—	—	—	—	7.9	12.7	15.9
900	36	914.4	—	—	—	—	—	7.9	12.7	15.9
950	38	965.2	—	—	—	—	—	—	—	—
1000	40	1016.0	—	—	—	—	—	—	—	—
1050	42	1066.8	—	—	—	—	—	—	—	—
1100	44	1117.6	—	—	—	—	—	—	—	—
1150	46	1168.4	—	—	—	—	—	—	—	—
1200	48	1219.2	—	—	—	—	—	—	—	—

*1 Figures are converted from inch to mm (inch=25.4mm)

ASME B36.10
ASME B36.19

(mm)

Nominal Wall Thickness										Nominal Pipe Size	
STD	Sch40	Sch60	XS	Sch80	Sch100	Sch120	Sch140	Sch160	XXS	A	B
2.2	2.2	—	3.0	3.0	—	—	—	—	—	8	1/4
2.3	2.3	—	3.2	3.2	—	—	—	—	—	10	3/8
2.8	2.8	—	3.7	3.7	—	—	—	4.8	7.5	15	1/2
2.9	2.9	—	3.9	3.9	—	—	—	5.6	7.8	20	3/4
3.4	3.4	—	4.5	4.5	—	—	—	6.4	9.1	25	1
3.6	3.6	—	4.9	4.9	—	—	—	6.4	9.7	32	1-1/4
3.7	3.7	—	5.1	5.1	—	—	—	7.1	10.2	40	1-1/2
3.9	3.9	—	5.5	5.5	—	—	—	8.7	11.1	50	2
5.2	5.2	—	7.0	7.0	—	—	—	9.5	14.0	65	2-1/2
5.5	5.5	—	7.6	7.6	—	—	—	11.1	15.2	80	3
5.7	5.7	—	8.1	8.1	—	—	—	—	—	90	3-1/2
6.0	6.0	—	8.6	8.6	—	11.1	—	13.5	17.1	100	4
6.6	6.6	—	9.5	9.5	—	12.7	—	15.9	19.1	125	5
7.1	7.1	—	11.0	11.0	—	14.3	—	18.3	21.9	150	6
8.2	8.2	10.3	12.7	12.7	15.1	18.3	20.6	23.0	22.2	200	8
9.3	9.3	12.7	12.7	15.1	18.3	21.4	25.4	28.6	25.4	250	10
9.5	10.3	14.3	12.7	17.5	21.4	25.4	28.6	33.3	25.4	300	12
9.5	11.1	15.1	12.7	19.1	23.8	27.8	31.8	35.7	—	350	14
9.5	12.7	16.7	12.7	21.4	26.2	31.0	36.5	40.5	—	400	16
9.5	14.3	19.1	12.7	23.8	29.4	34.9	39.7	45.2	—	450	18
9.5	15.1	20.6	12.7	26.2	32.5	38.1	44.5	50.0	—	500	20
9.5	—	22.2	12.7	28.6	34.9	41.3	47.6	54.0	—	550	22
9.5	17.5	24.6	12.7	31.0	38.9	46.0	52.4	59.5	—	600	24
9.5	—	—	12.7	—	—	—	—	—	—	650	26
9.5	—	—	12.7	—	—	—	—	—	—	700	28
9.5	—	—	12.7	—	—	—	—	—	—	750	30
9.5	17.5	—	12.7	—	—	—	—	—	—	800	32
9.5	17.5	—	12.7	—	—	—	—	—	—	850	34
9.5	19.1	—	12.7	—	—	—	—	—	—	900	36
9.5	—	—	12.7	—	—	—	—	—	—	950	38
9.5	—	—	12.7	—	—	—	—	—	—	1000	40
9.5	—	—	12.7	—	—	—	—	—	—	1050	42
9.5	—	—	12.7	—	—	—	—	—	—	1100	44
9.5	—	—	12.7	—	—	—	—	—	—	1150	46
9.5	—	—	12.7	—	—	—	—	—	—	1200	48

Wall Thickness Schedules (JIS)

Nominal Pipe Size		Outside Diameter	Nominal Wall Thickness							
A	B		Sch5S	Sch10S	Sch20S	FSGP	LG	Sch10	Sch20	Sch30
8	1/4	13.8	1.2	1.65	2.0	2.3	—	—	—	—
10	3/8	17.3	1.2	1.65	2.0	2.3	—	—	—	—
15	1/2	21.7	1.65	2.1	2.5	2.8	—	—	—	—
20	3/4	27.2	1.65	2.1	2.5	2.8	—	—	—	—
25	1	34.0	1.65	2.8	3.0	3.2	—	—	—	—
32	1-1/4	42.7	1.65	2.8	3.0	3.5	—	—	—	—
40	1-1/2	48.6	1.65	2.8	3.0	3.5	—	—	—	—
50	2	60.5	1.65	2.8	3.5	3.8	—	—	3.2	—
65	2-1/2	76.3	2.1	3.0	3.5	4.2	—	—	4.5	—
80	3	89.1	2.1	3.0	4.0	4.2	—	—	4.5	—
90	3-1/2	101.6	2.1	3.0	4.0	4.2	—	—	4.5	—
100	4	114.3	2.1	3.0	4.0	4.5	—	—	4.9	—
125	5	139.8	2.8	3.4	5.0	4.5	—	—	5.1	—
150	6	165.2	2.8	3.4	5.0	5.0	5.0	—	5.5	—
175	7	190.7	—	—	—	5.3	—	—	—	—
200	8	216.3	2.8	4.0	6.5	5.8	5.8	—	6.4	7.0
225	9	241.8	—	—	—	6.2	—	—	—	—
250	10	267.4	3.4	4.0	6.5	6.6	6.6	—	6.4	7.8
300	12	318.5	4.0	4.5	6.5	6.9	6.9	—	6.4	8.4
350	14	355.6	4.0	5.0	8.0	7.9	7.9	6.4	7.9	9.5
400	16	406.4	4.5	5.0	8.0	7.9	7.9	6.4	7.9	9.5
450	18	457.2	4.5	5.0	8.0	7.9	7.9	6.4	7.9	11.1
500	20	508.0	5.0	5.5	9.5	7.9	7.9	6.4	9.5	12.7
550	22	558.8	5.0	5.5	9.5	—	7.9	6.4	9.5	12.7
600	24	609.6	5.5	6.5	9.5	—	7.9	6.4	9.5	14.3
650	26	660.4	5.5	8.0	12.7	—	7.9	7.9	12.7	—
700	28	711.2	5.5	8.0	12.7	—	7.9	7.9	12.7	15.9
750	30	762.0	6.5	8.0	12.7	—	7.9	7.9	12.7	15.9
800	32	812.8	—	8.0	12.7	—	7.9	7.9	12.7	15.9
850	34	863.6	—	8.0	12.7	—	7.9	7.9	12.7	15.9
900	36	914.4	—	8.0	12.7	—	7.9	7.9	12.7	15.9
950	38	965.2	—	—	—	—	7.9	—	—	—
1000	40	1016.0	—	9.5	14.3	—	7.9	—	—	—
1050	42	1066.8	—	—	—	—	7.9	—	—	—
1100	44	1117.6	—	—	—	—	7.9	—	—	—
1150	46	1168.4	—	—	—	—	7.9	—	—	—
1200	48	1219.2	—	—	—	—	7.9	—	—	—

*: No standard in JIS. However, needs by customer, it is applied from ASME B36.10.

JIS G3452
JIS G3454
JIS G3455
JIS G3456
JIS G3459
JIS G3460
JIS G3468

(mm)

Nominal Wall Thickness										Nominal Pipe Size	
STD	Sch40	Sch60	XS	Sch80	Sch100	Sch120	Sch140	Sch160	XXS	A	B
*2.2	2.2	2.4	*3.0	3.0	—	—	—	—	—	8	1/4
*2.3	2.3	2.8	*3.2	3.2	—	—	—	—	—	10	3/8
*2.8	2.8	3.2	*3.7	3.7	—	—	—	4.7	*7.5	15	1/2
*2.9	2.9	3.4	*3.9	3.9	—	—	—	5.5	*7.8	20	3/4
*3.4	3.4	3.9	*4.5	4.5	—	—	—	6.4	*9.1	25	1
*3.6	3.6	4.5	*4.9	4.9	—	—	—	6.4	*9.7	32	1-1/4
*3.7	3.7	4.5	*5.1	5.1	—	—	—	7.1	*10.2	40	1-1/2
*3.9	3.9	4.9	*5.5	5.5	—	—	—	8.7	*11.1	50	2
*5.2	5.2	6.0	*7.0	7.0	—	—	—	9.5	*14.0	65	2-1/2
*5.5	5.5	6.6	*7.6	7.6	—	—	—	11.1	*15.2	80	3
*5.7	5.7	7.0	*8.1	8.1	—	—	—	12.7	—	90	3-1/2
*6.0	6.0	7.1	*8.6	8.6	—	11.1	—	13.5	*17.1	100	4
*6.6	6.6	8.1	*9.5	9.5	—	12.7	—	15.9	*19.0	125	5
*7.1	7.1	9.3	*11.0	11.0	—	14.3	—	18.2	*21.9	150	6
—	—	—	—	—	—	—	—	—	—	175	7
*8.2	8.2	10.3	*12.7	12.7	15.1	18.2	20.6	23.0	*22.2	200	8
—	—	—	—	—	—	—	—	—	—	225	9
*9.3	9.3	12.7	*12.7	15.1	18.2	21.4	25.4	28.6	*25.4	250	10
*9.5	10.3	14.3	*12.7	17.4	21.4	25.4	28.6	33.3	*25.4	300	12
9.5	11.1	15.1	12.7	19.0	23.8	27.8	31.8	35.7	—	350	14
9.5	12.7	16.7	12.7	21.4	26.2	30.9	36.5	40.5	—	400	16
9.5	14.3	19.0	12.7	23.8	29.4	34.9	39.7	45.2	—	450	18
9.5	15.1	20.6	12.7	26.2	32.5	38.1	44.4	50.0	—	500	20
9.5	15.9	22.2	12.7	28.6	34.9	41.3	47.6	54.0	—	550	22
9.5	17.5	24.6	12.7	31.0	38.9	46.0	52.4	59.5	—	600	24
9.5	18.9	26.4	12.7	34.0	41.6	49.1	56.6	64.2	—	650	26
9.5	—	—	12.7	—	—	—	—	—	—	700	28
9.5	—	—	12.7	—	—	—	—	—	—	750	30
9.5	—	—	12.7	—	—	—	—	—	—	800	32
9.5	—	—	12.7	—	—	—	—	—	—	850	34
9.5	—	—	12.7	—	—	—	—	—	—	900	36
9.5	—	—	12.7	—	—	—	—	—	—	950	38
9.5	—	—	12.7	—	—	—	—	—	—	1000	40
9.5	—	—	12.7	—	—	—	—	—	—	1050	42
9.5	—	—	12.7	—	—	—	—	—	—	1100	44
9.5	—	—	12.7	—	—	—	—	—	—	1150	46
9.5	—	—	12.7	—	—	—	—	—	—	1200	48

BUTT-WELDING FITTINGS WEIGHT AND VOLUME

Nominal Pipe Size	WEIGHT (Kg)									
	90° LONG		90° SHORT		TEE		CAP		REDUCER	
	STD	XS	STD	XS	STD	XS	STD	XS	STD	XS
1/2	0.08	0.10	—	—	0.08	0.11	0.04	0.05	—	—
3/4	0.10	0.13	—	—	0.12	0.16	0.05	0.07	0.06	0.07
1	0.15	0.19	0.10	0.13	0.25	0.31	0.11	0.14	0.11	0.14
1-1/4	0.26	0.34	0.17	0.22	0.42	0.55	0.14	0.19	0.15	0.20
1-1/2	0.37	0.49	0.24	0.32	0.60	0.80	0.17	0.23	0.24	0.32
2	0.65	0.89	0.43	0.59	0.87	1.19	0.23	0.33	0.37	0.50
2-1/2	1.30	1.70	0.87	1.14	1.67	2.19	0.40	0.53	0.70	0.91
3	2.03	2.73	1.35	1.82	2.41	3.25	0.66	0.91	0.91	1.22
3-1/2	2.82	3.91	1.88	2.61	3.17	4.39	0.96	1.36	1.28	1.77
4	3.83	5.36	2.55	3.57	4.11	5.75	1.17	1.68	1.53	2.14
5	6.55	9.23	4.37	6.15	6.60	9.30	1.92	2.77	2.50	3.52
6	10.1	15.3	6.75	10.2	9.71	14.7	2.89	4.48	3.61	5.45
8	20.4	30.9	13.6	20.6	18.1	27.4	5.20	8.05	5.71	8.63
10	36.2	48.7	24.1	32.5	30.9	41.7	9.17	12.5	9.65	13.0
12	52.8	69.9	35.2	46.6	44.2	58.4	13.3	17.7	13.7	18.2
14	67.9	89.9	45.2	59.9	53.5	70.9	15.9	21.2	25.5	33.8
16	89.0	118.0	59.3	78.6	66.1	87.7	20.0	26.7	30.9	41.0
18	112.9	149.8	75.3	99.9	83.9	111.3	25.5	34.1	37.7	50.0
20	139.7	185.5	93.1	123.7	103.8	137.8	31.8	42.5	56.3	74.7
22	169.3	225.0	112.8	150.0	125.8	167.2	38.7	51.7	62.3	82.8
24	201.7	268.3	134.5	178.8	139.2	185.1	45.0	60.1	68.4	90.9
26	237.0	315.3	158.0	210.2	176.1	234.3	50.3	67.3	89.3	118.7
28	275.2	366.2	183.5	244.2	198.2	263.8	56.0	74.8	96.5	128.4
30	316.2	420.9	210.8	280.6	228.3	303.9	61.9	82.8	103.8	138.1
32	360.1	479.4	240.0	319.6	260.4	346.7	68.2	91.2	111.0	147.8
34	406.8	541.7	271.2	361.2	294.6	392.4	74.8	100.0	118.3	157.5
36	456.3	607.8	304.2	405.2	331.0	440.9	81.7	109.2	125.5	167.2
38	508.7	677.8	—	—	369.5	492.3	94.4	126.2	132.8	176.9
40	563.9	751.5	376.0	501.0	410.1	546.5	102.1	136.5	140.0	186.6
42	622.0	829.0	414.7	552.7	421.3	561.6	110.1	147.2	147.3	196.3
44	682.9	910.3	455.3	606.9	474.5	632.5	124.9	166.9	154.5	206.0
46	746.7	995.5	—	—	520.4	693.8	133.7	178.7	188.8	251.6
48	813.3	1,084.4	542.2	722.9	568.4	757.9	142.8	191.0	197.2	262.9

* Weight and volume are according to theoretical calculation.

* Figures of tees are on equal tees and figures of reducers are on one size reduction reducers.

VOLUME (m ³)					Nominal Pipe Size
90° LONG	90° SHORT	TEE	CAP	REDUCER	
—	—	—	—	—	1/2
—	—	—	—	—	3/4
—	—	—	—	—	1
—	—	—	—	—	1-1/4
—	—	—	—	—	1-1/2
0.001	0.001	0.001	—	—	2
0.002	0.001	0.001	—	0.001	2-1/2
0.003	0.002	0.002	—	0.001	3
0.004	0.003	0.003	0.001	0.001	3-1/2
0.005	0.004	0.004	0.001	0.001	4
0.010	0.007	0.007	0.001	0.002	5
0.016	0.011	0.011	0.002	0.004	6
0.037	0.025	0.022	0.005	0.007	8
0.070	0.046	0.040	0.009	0.013	10
0.118	0.079	0.067	0.015	0.021	12
0.164	0.109	0.091	0.021	0.042	14
0.245	0.163	0.126	0.029	0.059	16
0.349	0.232	0.179	0.042	0.080	18
0.479	0.319	0.246	0.059	0.131	20
0.638	0.424	0.327	0.052	0.159	22
0.828	0.551	0.388	0.066	0.189	24
1.053	0.700	0.540	0.083	0.266	26
1.315	0.875	0.649	0.103	0.308	28
1.618	1.076	0.800	0.125	0.354	30
1.964	1.306	0.974	0.151	0.403	32
2.355	1.566	1.170	0.180	0.455	34
2.796	1.859	1.391	0.212	0.510	36
3.288	2.187	1.639	0.248	0.568	38
3.835	2.550	1.914	0.288	0.629	40
4.440	2.953	2.023	0.332	0.694	42
5.105	3.395	2.400	0.381	0.761	44
5.833	3.879	2.753	0.433	0.971	46
6.627	4.407	3.138	0.491	1.057	48

Long and Short Radius Elbows

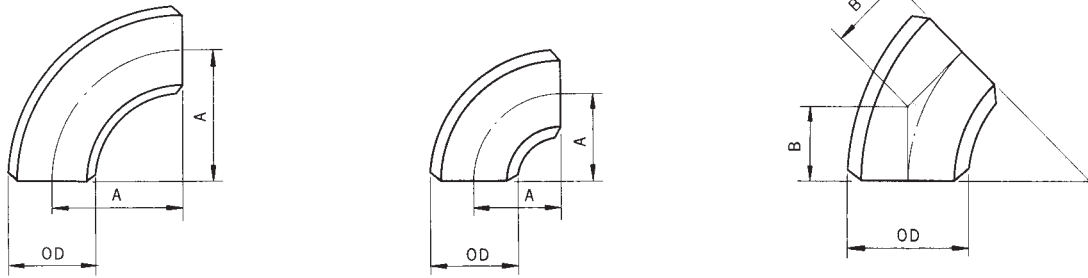

ASME B16.9

*BENKAN's Standards (mm)

Nominal Pipe Size (NPS)	Outside Diameter at Bevel OD	Center-to-End			
		Long Radius Elbow		Short Radius Elbow	
		90 Deg. A	45 Deg. B	90 Deg. A	45 Deg.* B
1/2	21.3	38.1	15.7	—	—
3/4	26.7	38.1	19.1	—	—
1	33.4	38.1	22.4	25.4	—
1-1/4	42.2	47.8	25.4	31.8	—
1-1/2	48.3	57.2	28.4	38.1	—
2	60.3	76.2	35.1	50.8	—
2-1/2	73.0	95.3	44.5	63.5	—
3	88.9	114.3	50.8	76.2	31.6
3-1/2	101.6	133.4	57.2	88.9	36.8
4	114.3	152.4	63.5	101.6	42.1
5	141.3	190.5	79.2	127.0	52.6
6	168.3	228.6	95.3	152.4	63.4
8	219.1	304.8	127.0	203.2	84.2
10	273.0	381.0	158.8	254.0	105.2
12	323.8	457.2	190.5	304.8	126.3
14	355.6	533.4	222.3	355.6	147.3
16	406.4	609.6	254.0	406.4	168.3
18	457.2	685.8	285.8	457.2	189.4
20	508.0	762.0	317.5	508.0	210.4
22	558.8	838.2	342.9	558.8	231.5
24	609.6	914.4	381.0	609.6	252.5
26	660.4	990.6	406.4	660.4*	273.5
28	711.2	1066.8	438.2	711.2*	294.6
30	762.0	1143.0	469.9	762.0*	315.6
32	812.8	1219.2	501.7	812.8*	336.7
34	863.6	1295.4	533.4	863.6*	357.7
36	914.4	1371.6	565.2	914.4*	378.8
38	965.2	1447.8	599.9	965.2*	399.8
40	1016.0	1524.0	632.0	1016.0*	420.8
42	1066.8	1600.2	660.4	1066.8*	441.9
44	1117.6	1676.4	695.5	1117.6*	462.9
46	1168.4	1752.6	726.9	—	—
48	1219.2	1828.8	759.0	1219.2*	505.0
52*	1320.8	—	—	1320.8	547.1
54*	1371.6	2057.4	852.2	1371.6	568.1
56*	1422.4	2133.6	883.8	—	—
60*	1524.0	2286.0	946.9	1524.0	631.3
66*	1676.4	2514.6	1041.6	—	—
72*	1828.8	2743.2	1262.5	—	—
80*	2032.0	—	—	2032.0	841.7

Long and Short Radius Return Elbows

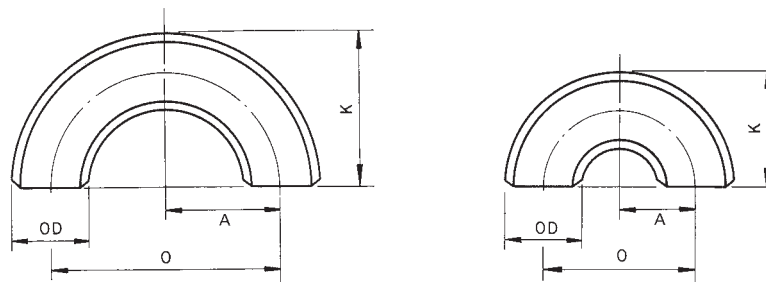

ASME B16.9
(mm)

Nominal Pipe Size (NPS)	Outside Diameter at Bevel OD	Long Radius		Short Radius	
		Center-to-Center O	Back-to-Face K	Center-to-Center O	Back-to-Face K
1/2	21.3	76.2	47.8	—	—
3/4	26.7	76.2	50.8	—	—
1	33.4	76.2	55.6	50.8	41.1
1-1/4	42.2	95.3	69.9	63.5	52.3
1-1/2	48.3	114.3	82.6	76.2	62.0
2	60.3	152.4	106.4	101.6	81.0
2-1/2	73.0	190.5	131.8	127.0	100.1
3	88.9	228.6	158.8	152.4	120.7
3-1/2	101.6	266.7	184.2	177.8	139.7
4	114.3	304.8	209.6	203.2	158.8
5	141.3	381.0	261.9	254.0	196.9
6	168.3	457.2	312.7	304.8	236.5
8	219.1	609.6	414.3	406.4	312.7
10	273.0	762.0	517.6	508.0	390.7

Straight and Reducing Tees

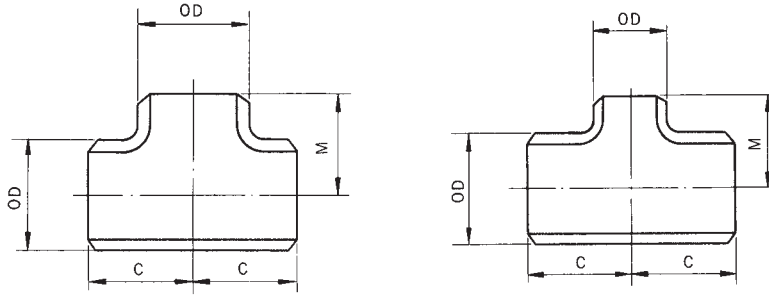

**MSS SP-75
ASME B16.9**

*BENKAN's Standards (mm)

Nominal Pipe Size (NPS)	Outside Diameter at Bevel OD		Center-to-End		Nominal Pipe Size (NPS)	Outside Diameter at Bevel OD		Center-to-End	
	Run	Outlet	Run C	Outlet(1)(2) M		Run	Outlet	Run C	Outlet(1)(2) M
1/2 x 1/2	21.3	21.3	25.4	25.4	5 x 5	141.3	141.3	124.0	124.0
3/8		17.3		25.4	4		114.3		117.3
1/4		13.7		25.4	3-1/2		101.6		114.3
3/4 x 3/4	26.7	26.7	28.4	28.4	3		88.9		111.3
1/2		21.3		28.4	2-1/2		73.0		108.0
3/8		17.3		28.4	2		60.3		104.6
1 x 1	33.4	33.4	38.1	38.1	1-1/2*		48.3		
3/4		26.7		38.1	6 x 6	168.3	168.3	142.7	142.7
1/2		21.3		38.1	5		141.3		136.7
1-1/4 x 1-1/4	42.2	42.2	47.8	47.8	4		114.3		130.0
1		33.4		47.8	3-1/2		101.6		127.0
3/4		26.7		47.8	3		88.9		124.0
1/2		21.3		47.8	2-1/2		73.0		120.7
1-1/2 x 1-1/2	48.3	48.3	57.2	57.2	2*		60.3		
1-1/4		42.2		57.2	8 x 8	219.1	219.1	177.8	177.8
1		33.4		57.2	6		168.3		168.1
3/4		26.7		57.2	5		141.3		162.1
1/2		21.3		57.2	4		114.3		155.5
2 x 2	60.3	60.3	63.5	63.5	3-1/2		101.6		152.4
1-1/2		48.3		60.5	3*		88.9		
1-1/4		42.2		57.2	10 x 10	273.0	273.0	215.9	215.9
1		33.4		50.8	8		219.1		203.2
3/4		26.7		44.5	6		168.3		193.5
1/2*		21.3			5		141.3		190.5
2-1/2 x 2-1/2	73.0	73.0	76.2	76.2	4		114.3		184.2
2		60.3		69.9	12 x 12	323.8	323.8	254.0	254.0
1-1/2		48.3		66.5	10		273.1		241.3
1-1/4		42.2		63.5	8		219.1		228.6
1		33.4		57.2	6		168.3		218.9
3 x 3	88.9	88.9	85.9	85.9	5		141.3		215.9
2-1/2		73.0		82.6	14 x 14	355.6	355.6	279.4	279.4
2		60.3		76.2	12		323.8		269.7
1-1/2		48.3		73.2	10		273.0		257.0
1-1/4		42.2		69.9	8		219.1		247.7
1*		33.4			6		168.3		238.3
3-1/2 x 3-1/2	101.6	101.6	95.3	95.3	16 x 16	406.4	406.4	304.8	304.8
3		88.9		91.9	14		355.6		304.8
2-1/2		73.0		88.9	12		323.8		295.1
2		60.3		82.6	10		273.0		282.4
1-1/2		48.3		79.2	8		219.1		273.1
4 x 4	114.3	114.3	104.6	104.6	6		168.3		263.7
3-1/2		101.6		101.6	18 x 18	457.2	457.2	342.9	342.9
3		88.9		98.6	16		406.4		330.2
2-1/2		73.0		95.3	14		355.6		330.2
2		60.3		88.9	12		323.8		320.5
1-1/2		48.3		85.9	10		273.0		307.8
1-1/4*		42.2			8		219.1		298.5
1*		33.5							

Note (1) Outlet dimension "M" for NPS 26 and larger is recommended but not required.

Note (2) Outlet dimension "M" for run sizes NPS 14 and larger is recommended but not required.

Straight and Reducing Tees

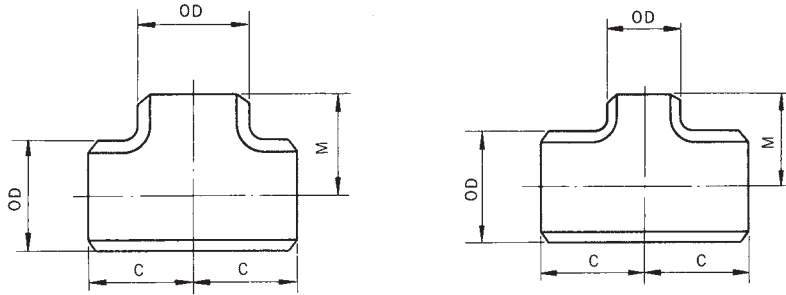

**MSS SP-75
ASME B16.9**

*BENKAN's Standards (mm)

Nominal Pipe Size (NPS)	Outside Diameter at Bevel OD		Center-to-End		Nominal Pipe Size (NPS)	Outside Diameter at Bevel OD		Center-to-End			
	Run	Outlet	Run C	Outlet(1)(2) M		Run	Outlet	Run C	Outlet(1)(2) M		
20 x 20	508.0	508.0	381.0	381.0	30 x 12	762.0	323.8	558.8	472.6		
18		457.2		368.3	10		273.0		460.2		
16		406.4		355.6	32 x 32	812.8	812.8	596.9	596.9		
14		355.6		355.6			30		762.0	584.2	
12		323.8		345.9			28		711.2	571.5	
10		273.0		333.2			26		660.4	571.5	
8		219.1		323.9			24		609.6	558.8	
22 x 22	558.8	558.8	419.1	419.1	22	558.8	546.1				
20		508.0		406.4	20	508.0	533.4				
18		457.2		393.7	18	457.2	520.7				
16		406.4		381.0	16	406.4	508.0				
14		355.6		381.0	14	355.6	508.0				
12		323.8		371.3	34 x 34	863.6	863.6	635.0	635.0		
10	273.0	358.6	32	812.8			622.3				
24 x 24	609.6	609.6	431.8	431.8	30	762.0	609.6				
22		558.8		431.8	28	711.2	596.9				
20		508.0		431.8	26	660.4	596.9				
18		457.2		419.1	24	609.6	584.2				
16		406.4		406.4	22	558.8	571.5				
14		355.6		406.4	20	508.0	558.8				
12		323.8		396.7	18	457.2	546.1				
10		273.0		384.0	16	406.4	533.4				
26 x 26		660.4		660.4	495.3	495.3	36 x 36	914.4	914.4	673.1	673.1
24	609.6		482.6	34		863.6	660.4				
22	558.8		469.9	32		812.8	647.7				
20	508.0		457.2	30		762.0	635.0				
18	457.2		444.5	28		711.2	622.3				
16	406.4		431.8	26		660.4	622.3				
14	355.6		431.8	24		609.6	609.6				
12	323.8		422.1	22		558.8	596.9				
28 x 28	711.2		711.2	520.7		520.7	20		508.0		584.2
			660.4			520.7	18		457.2		571.5
		609.6	508.0		16	406.4	558.8				
		558.8	495.3		38 x 38	965.2	965.2	711.2	711.2		
		508.0	482.6				36		914.4	711.2	
		457.2	469.9				34		863.6	698.5	
406.4	457.2	32	812.8	685.8							
14	355.6	457.2	30	762.0	673.1						
12	323.8	447.5	28	711.2	647.7						
30 x 30	762.0	762.0	558.8	558.8	26	660.4	647.7				
		711.2		546.1	24	609.6	635.0				
		660.4		546.1	22	558.8	622.3				
		609.6		533.4	20	508.0	609.6				
		558.8		520.7	18	457.2	596.9				
		508.0		508.0							
		457.2		495.3							
		406.4		482.6							
		355.6		482.6							

Straight and Reducing Tees

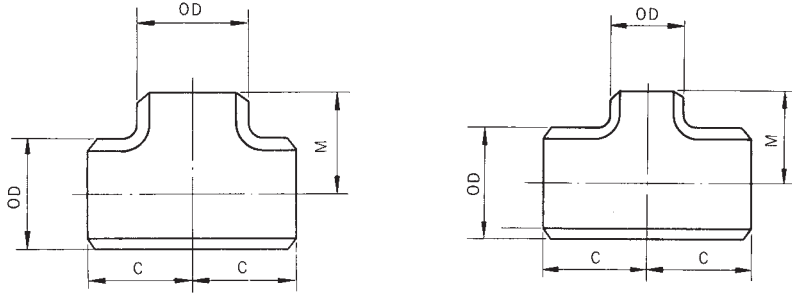

**MSS SP-75
ASME B16.9**

*BENKAN's Standards (mm)

Nominal Pipe Size (NPS)	Outside Diameter at Bevel OD		Center-to-End		Nominal Pipe Size (NPS)	Outside Diameter at Bevel OD		Center-to-End	
	Run	Outlet	Run C	Outlet(1)(2) M		Run	Outlet	Run C	Outlet(1)(2) M
40 x 40	1016.0	1016.0	749.3	749.3	46 x 26	1168.4	660.4	850.9	736.6
38		965.2		749.3	24		609.6		723.9
36		914.4		736.6	22		558.8		723.9
34		863.6		723.9	20*		508.0		723.9
32		812.8		711.2	48 x 48	1219.2	1219.2	889.0	838.2
30		762.0		698.5	46		1168.4		838.2
28		711.2		673.1	44		1117.6		838.2
26		660.4		673.1	42		1066.8		812.8
24		609.6		660.4	40		1016.0		812.8
22		558.8		647.7	38		965.2		812.8
20		508.0		635.0	36		914.4		787.4
18		457.2		622.3	34		863.6		787.4
42 x 42	1066.8	1066.8	762.0	711.2	32		812.8		787.4
40		1016.0		711.2	30		762.0		762.0
38		965.2		711.2	28		711.2		762.0
36		914.4		711.2	26		660.4		762.0
34		863.6		711.2	24		609.6		736.6
32		812.8		711.2	22		558.8		736.6
30		762.0		711.2	52 x 52*	1320.8	1320.8	965.2	914.4
28		711.2		698.5	48*		1219.2		863.6
26		660.4		698.5	44*		1117.6		812.8
24		609.6		660.4	40*		1016.0		762.0
22		558.8		660.4	54 x 54*	1371.6	1371.6	1003.3	952.5
20		508.0		660.4	52*		1320.8		914.4
18		457.2		647.7	48*		1219.2		863.6
16		406.4		635.0	44*		1117.6		863.6
44 x 44	1117.6	1117.6	812.8	762.0	40*		1016.0		812.8
42		1066.8		762.0	28*		711.2		787.4
40		1016.0		749.3	20*		508.0		787.4
38		965.2		736.6	56 x 56*	1422.4	1422.4	1041.4	965.2
36		914.4		723.9	52*		1320.8		914.4
34		863.6		723.9	48*		1219.2		863.6
32		812.8		711.2	44*		1117.6		812.8
30		762.0		711.2	40*		1016.0		812.8
28		711.2		698.5	28*		711.2		812.8
26		660.4		698.5	20*		508.0		812.8
24		609.6		698.5	60 x 60*	1524.0	1524.0	1117.6	1016.0
22		558.8		685.8	56*		1422.4		965.2
20		508.0		685.8	52*		1320.8		914.4
46 x 46	1168.4	1168.4	850.9	800.1	48*		1219.2		863.6
44		1117.6		800.1	40*		1016.0		863.6
42		1066.8		787.4	28*		711.2		863.6
40		1016.0		774.7	20*		508.0		863.6
38		965.2		762.0	66 x 66*	1676.4	1676.4	1219.2	1066.8
36		914.4		762.0					
34		863.6		749.3					
32		812.8		749.3					
30		762.0		736.6					
28		711.2		736.6					

Concentric and Eccentric Reducers

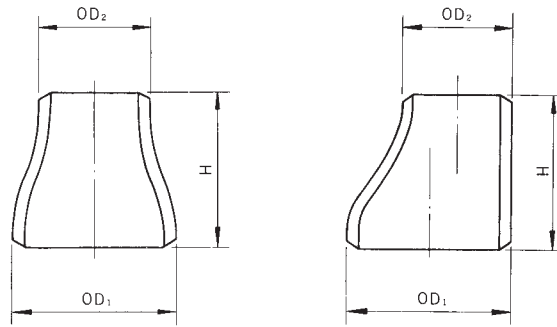

**MSS SP-75
ASME B16.9**

*BENKAN's Standards (mm)

Nominal Pipe Size (NPS)	Outside Diameter at Bevel		End-to-End H	Nominal Pipe Size (NPS)	Outside Diameter at Bevel		End-to-End H	Nominal Pipe Size (NPS)	Outside Diameter at Bevel		End-to-End H
	Large End OD ₁	Small End OD ₂			Large End OD ₁	Small End OD ₂			Large End OD ₁	Small End OD ₂	
3/4 x 1/2 3/8	26.7	21.3 17.3	38.1	10 x 8 6	273.0	219.1 168.3	177.8	34 x 32 30	863.6	812.8 762.0	609.6
1 x 3/4 1/2	33.4	26.7 21.3	50.8	5 4		141.3 114.3		26 24		660.4 609.6	
1-1/4 x 1 3/4 1/2	42.2	33.4 26.7 21.3	50.8	12 x 10 8 6	323.8	273.0 219.1 168.3	203.2	36 x 34 32 30	914.4	863.6 812.8 762.0	609.6
1-1/2 x 1-1/4 1 3/4 1/2	48.3	42.2 33.4 26.7 21.3	63.5	5 14 x 12 10 8		141.3 323.8 273.0 219.1		26 24 38 x 36 34		660.4 609.6 914.4 863.6	
2 x 1-1/2 1-1/4 1 3/4	60.3	48.3 42.2 33.4 26.7	76.2	6 16 x 14 12 10	406.4	355.6 323.8 273.0	355.6	32 30 28 26		812.8 762.0 711.2 660.4	
2-1/2 x 2 1-1/2 1-1/4 1	73.0	60.3 48.3 42.2 33.4	88.9	8 18 x 16 14 12		219.1 406.4 355.6 323.8		40 x 38 36 34 32	1016.0	965.2 914.4 863.6 812.8	609.6
3 x 2-1/2 2 1-1/2 1-1/4	88.9	73.0 60.3 48.3 42.2	88.9	10 20 x 18 16 14		273.0 508.0 457.2 406.4		30 42 x 40 38 36		762.0 1016.0 965.2 914.4	
3-1/2 x 3 2-1/2 2 1-1/2 1-1/4	101.6	88.9 73.0 60.3 48.3 42.2	101.6	12 22 x 20 18 16		323.8 508.0 457.2 406.4 355.6		34 32 30 44 x 42 40		863.6 812.8 762.0 1066.8 1016.0	609.6
4 x 3-1/2 3 2-1/2 2 1-1/2	114.3	101.6 88.9 73.0 60.3 48.3	101.6	14 24 x 22 20 18 16		355.6 609.6 558.8 508.0 457.2		36 46 x 44 42 40		914.4 965.2 914.4 1066.8 1016.0	
5 x 4 3-1/2 3 2-1/2 2	141.3	114.3 101.6 88.9 73.0 60.3	127.0	16 26 x 24 22 20		406.4 609.6 558.8 508.0		38 48 x 46 44 42		965.2 1066.8 1117.6 1066.8	
6 x 5 4 3-1/2 3 2-1/2	168.3	141.3 114.3 101.6 88.9 73.0	139.7	18 30 x 28 26 24		457.2 711.2 660.4 609.6		40 40 40		1016.0 1168.4 1066.8 1016.0	
8 x 6 5 4 3-1/2	219.1	168.3 141.3 114.3 101.6	152.4	20 32 x 30 28 26 24		508.0 711.2 660.4 609.6 508.0		40 40 40		1016.0 1168.4 1066.8 1016.0	

Note (1) The shape of Reducer sizes 16" and larger may be manufactured to conical type without the tangent.
 (2) 48" and larger can be manufactured. Please contact us for size capability.

Caps

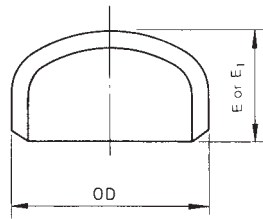

MSS SP-75
ASME B16.9
 (mm)

Nominal Pipe Size (NPS)	Outside Diameter at Bevel OD	Length ⁽²⁾ E	Limiting Wall Thickness for Length E	Length ⁽³⁾ E ₁
1/2	21.3	25.4	4.6	25.4
3/4	26.7	25.4	3.8	25.4
1	33.4	38.1	4.6	38.1
1-1/4	42.2	38.1	4.8	38.1
1-1/2	48.3	38.1	5.1	38.1
2	60.3	38.1	5.6	44.5
2-1/2	73.0	38.1	7.1	50.8
3	88.9	50.8	7.6	63.5
3-1/2	101.6	63.5	8.1	76.2
4	114.3	63.5	8.6	76.2
5	141.3	76.2	9.7	88.9
6	168.3	88.9	10.9	101.6
8	219.1	101.6	12.7	127.0
10	273.0	127.0	12.7	152.4
12	323.8	152.4	12.7	177.8
14	355.6	165.1	12.7	190.5
16	406.4	177.8	12.7	203.2
18	457.2	203.2	12.7	228.6
20	508.0	228.6	12.7	254.0
22	558.8	254.0	12.7	254.0
24	609.6	266.7	12.7	304.8

Nominal Pipe Size (NPS)	Outside Diameter at Bevel OD	Length E
26	660.4	266.7
28	711.2	266.7
30	762.0	266.7
32	812.8	266.7
34	863.6	266.7
36	914.4	266.7
38	965.2	304.8
40	1016.0	304.8
42	1066.8	304.8
44	1117.6	342.9
46	1168.4	342.9
48	1219.2	342.9

- Wall thickness for Caps up to and including 36" conform to ASME B36.10 Specifications; Caps 38" and larger conform to XS Specifications for wall thicknesses of 36". These are BENKAN Standards as no Internationally Recognized Standards have been set for such large size wall thickness.

- (1) The shape of these caps shall be ellipsoidal and shall conform to the shape requirements as given in the ASME Boiler and Pressure Vessel Code.
- (2) Length E applies for thickness not exceeding that given in column "Limiting wall Thickness for Length E".
- (3) Length E₁ applies for thickness greater than that given in column "Limiting wall Thickness" for NPS 24 and smaller. For NPS 26 and larger, Length E₁ shall be by agreement between manufacturer and purchaser.
- (4) 48" and larger can be manufactured. Please contact us for size capability.

Stainless Steel Lap Joint Stub Ends

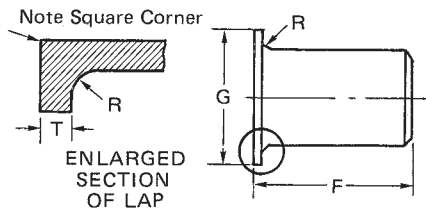

ASME B16.9

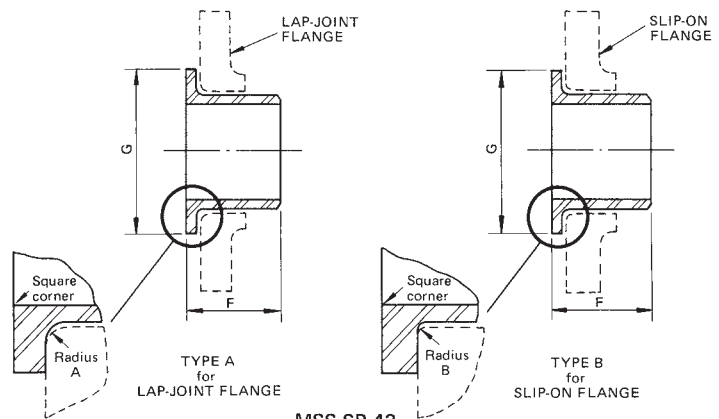

MSS SP-43

ASME B16.9

MSS SP-43

(mm)

NPS	Outside Diameter at Bevel	Outside Diameter of Barrel		Length F		Radius of Fillet R		Diameter of Lap G
		min	max	ASME (Long)	ASME (Short)&MSS	ASME & MSS Type A	MSS Type B	
1/2	21.3	20.5	22.8	76.2	50.8	3.0	0.8	35.1
3/4	26.7	25.9	28.1	76.2	50.8	3.0	0.8	42.9
1	33.4	32.6	35.0	101.6	50.8	3.0	0.8	50.8
1-1/4	42.2	41.4	43.6	101.6	50.8	4.8	0.8	63.5
1-1/2	48.3	47.5	49.9	101.6	50.8	6.4	0.8	73.2
2	60.3	59.5	62.4	152.4	63.5	7.9	0.8	91.9
2-1/2	73.0	72.2	75.3	152.4	63.5	7.9	0.8	104.6
3	88.9	88.1	91.3	152.4	63.5	9.7	0.8	127.0
3-1/2	101.6	100.8	104.0	152.4	76.2	9.7	0.8	139.7
4	114.3	113.5	116.7	152.4	76.2	11.2	0.8	157.2
5	141.3	140.5	144.3	203.2	76.2	11.2	1.5	185.7
6	168.3	167.5	171.3	203.2	88.9	12.7	1.5	215.9
8	219.1	218.3	222.1	203.2	101.6	12.7	1.5	269.7
10	273.0	272.3	277.2	254.0	127.0	12.7	1.5	323.9
12	323.8	323.1	328.0	254.0	152.4	12.7	1.5	381.0
14	355.6	354.8	359.9	304.8	152.4	12.7	1.5	412.8
16	406.4	405.6	411.0	304.8	152.4	12.7	1.5	469.9
18	457.2	456.4	462.0	304.8	152.4	12.7	1.5	533.4
20	508.0	507.2	514.1	304.8	152.4	12.7	1.5	584.2
22	558.8	558.0	564.9	304.8	152.4	12.7	1.5	641.4
24	609.6	608.8	615.7	304.8	152.4	12.7	1.5	692.2

Material Specification for Butt-Welding Fittings

ASTM A234/A234M

Standard Specification for
Piping Fittings of Wrought Carbon Steel and Alloy Steel for Moderate and High Temperature Service

Grade and Marking Symbol
WPB, WPC, WP1, WP12 CL1, WP12 CL2, WP11 CL1, WP11 CL2, WP11 CL3, WP22 CL1, WP22 CL3, WP5 CL1, WP5 CL3, WP9 CL1, WP9 CL3, WPR, WP91, WP911, WP92

ASTM A420/A420M

Standard Specification for
Piping Fittings of Wrought Carbon and Alloy Steel for Low-Temperature Service

Grade and Marking Symbol
WPL6, WPL9, WPL3, WPL8

ASTM A403/A403M

Standard Specification for
Wrought Austenitic Stainless Steel Piping Fittings

Grade and Marking Symbol
WPXM-19, WP304, WP304L, WP304H, WP304L, WP309, WP310S, WPS31254, WP316, WP316L, WP316H, WP316N, WP316LN, WP317, WP317L, WPS31725, WP31726, WP321, WP321H, WPS33228, WPS34565, WP347, WP347H, WP348, WP348H, WPS38815

ASTM A815/A815M

Standard Specification for
Wrought Ferritic, Ferritic/Austenitic, and Martensitic Stainless Steel

Grade and Marking Symbol (extract)
Ferritic/Austenitic Stainless Steel WPS31803, WPS32101, WPS32750, WPS32950, WPS32760, WPS39274, WPS32550 WPS32205

ASTM A860/A860M

Standard Specification for
Wrought High-Strength Low-Alloy Steel Butt-Welding Fittings

Grade and Marking Symbol
WPHY42, WPHY46, WPHY52, WPHY60, WPHY65, WPHY70

ASTM B366

Standard Specification for
Factory-Made Wrought Nickel and Nickel Alloy Fittings

Grade and Marking Symbol (extract)
WPN, WPNL, WPNC, WPHX, WPHG, WPHC22, WPHG30, WPHC4, WPNC1, WPNCMC, WPHG3, WP20CB, WPNIC, WPNIC10, WPNIC11, WPNICMC, WP904L, WPHB, WPHC276, WPHB-2

MSS SP-75

Standard Specification for
High-Test, Wrought, Butt-Welding Fittings

Grade and Marking Symbol
WPHY-42, WPHY-46, WPHY-52, WPHY-56, WPHY-60, WPHY-65, WPHY-70

BENKAN® BENKAN KIKOH Corporation

TOKYO OFFICE 5-13, 2-chome, Sanno, Ota-ku, Tokyo, 143-8567, Japan
Tel: 81-3-3777-1541
Fax: 81-3-3777-1567

HEAD OFFICE 5-1, Rokusengoku-cho, Ota-city, Gunma, 379-2305, Japan
Tel: 81-277-78-4111
Fax: 81-277-78-4081